

# Series M22 Panel Mount Signaling Beacons and Alarms from Auer Signal



## Signaling Solutions...Loud and Clear

M22 Panel Mount Signaling Beacons and Alarms from the Auer company are the perfect compliment to Sprecher + Schuh's world class industrial control product line. High grade, heavy duty and comprehensive, these M22 Signaling Beacons and Alarms are a unique and powerful acoustic signaling solution.

In comparing M22 alarm sounders to competitive products in the alarm signaling industry, the M22 alarm sounders offer more features, approvals and options than any other manufacturer.



## Rugged construction for industrial applications

Heavy duty industrial polycarbonate is used to construct all M22 alarm sounders. The entire line meets UL Type 4 / 4X / 13 and IP65 guidelines for use indoors or out. No other manufacturer of competitive product offers this extensive range of environmental approvals.

## High Performance Sounders

All M22 alarm sounder models fit into a standard 22.5mm cut-out. There are four M22 alarms sounders models to choose from which range from 65 dBA to 105 dBA decibels at 1 meter. The higher the dBA sound level, the greater the diameter size of the rugged watertight M22 alarm sounders. There are three diameter sizes for the M22 alarm sounders of 30mm, 45mm and 65mm available in 24VDC/AC, 120VAC or 240VAC.

## Selectable Tone Types

The M22 alarm sounders are equipped with a plug-in three point finger-safe terminal block for ease of wiring and configuring the tone type. All M22 models can be configured for either Continuous or Pulsing tones as illustrated on the next page. The 65mm M22 alarm sounders can also be wired for a wobble tone (alternating frequency). Users may also adjust the intensity sound levels on the 45mm and 65mm M22 alarm models.

## Environmental Approvals

The M22 alarm sounders are cULus listed and CE marked for international markets. They are UL Type 4 / 4X / 13 and IP65 approved for harsh industrial environments. Specific to the food industry, the M22 30mm "812 510..." sounder housings are fully enclosed to prevent contaminants from accumulating. The M22 sounders are the perfect choice for your alarm signaling applications.







# AUDIBLE SIGNALING

## M22 Panel Mount Sounders Series

- Mounts in a standard 22.5 mm hole
- UL Type 4/4X/13, IP65
- Sound output range from 65 dB to 105 dB @ 1 meter
- Selectable continuous or pulsing sounders (wobble tone 65mm)
- Adjustable volume control (45mm & 65mm units)
- 12V-24V AC/DC, 120V AC, 240V AC
- Plug-in Terminal Block - IP2X Rated
- Captive design eliminates unauthorized product removal
- cULus listed and CE Marked

### Panel Mount Alarms, mounting hole 22.5 mm

Components	Description	Tone Types	Sound Level	Housing Color	Voltage	Catalog Number
	<b>ESK</b> <b>30 mm Diameter Sounder</b> ① • Fully enclosed, smooth front ①	Pulse / Continuous	65-70 dBa	Black	12...24V AC/DC	<b>812 500 405</b>
					120V AC	<b>812 500 310</b>
					240V AC	<b>812 500 313</b>
	<b>ESV</b> <b>30 mm Diameter Sounder</b> ① • Slots in housing, high output	Pulse / Continuous	80-85 dBa	Black	12...24V AC/DC	<b>812 510 405</b>
					120V AC	<b>812 510 310</b>
					240V AC	<b>812 510 313</b>
	<b>ESM</b> <b>45 mm Diameter Sounder</b> • Slots in housing, high output	Pulse / Continuous ②	85-100 dBa	Black	12...24V AC/DC	<b>813 500 405</b>
					120V AC	<b>813 500 310</b>
					240V AC	<b>813 500 313</b>
	<b>ESG</b> <b>65 mm Diameter Sounder</b> • Slots in housing, high output	Pulse / Continuous / Wobble ②	85-105 dBa	Black	12...24V AC/DC	<b>814 500 405</b>
					120V AC	<b>814 500 310</b>
					240V AC	<b>814 500 313</b>

① No slots in the housing. Ideal for food industry environments.

② Adjustable volume capabilities.

③ D7 Legend Plates can be used with the 30mm devices. Also, the mounting ring is the same as D7-ARP, which can be secured to a panel with use of the D7-AW2 mounting wrench. See Section H IN SSNA2012 Sprecher + Schuh catalog for D7 components.



### Alarm Tone Selection via terminal

Supply Voltage			Tone output	65mm	45mm	30mm
La	N	Lb				
X	X		Pulsing Tone	✓	✓	✓
	X	X	Wobble Tone (alternating frequency)	✓	~	~
X	X	X	Continuous Tone	✓	✓	✓

Jumper

Connect AC-Neutral to N, and AC-Line to La and/or Lb as appropriate.



# VISUAL SIGNALING

## M22 Panel Mount Beacon Series "I"

- Versatile usable panel mount beacon series
- For mounting in 22.5mm bore holes
- 3 sizes: 30, 45 and 65mm
- Selection of steady/flashing function, desired color via terminal
- Maintenance free – long lifetime
- PLC fit (leakage/inrush current)
- Lens pattern designed for optimum light dispersion

### Models

- LED steady-/flashing beacons
- Strobe beacons
- Multi-color beacons – whole lens with 1 color visible
- LED multi-color beacons – 2 colors visible – separated color areas
- UL Type 4/4X/13



**M22 Panel Mount Beacons with Plug In Terminal**  
available in 65mm, 45mm, and 30mm  
available in amber, red, clear, blue, green and yellow



**M22 Panel Mount Beacons in built in condition**  
available in 65mm, 45mm, and 30mm  
available in amber, red, clear, blue, green and yellow



**LED Multi Color Beacons**  
available in 65mm, 45mm, and 30mm  
available in amber, red, clear, blue, green and yellow  
One beacon provides ability to choose between 2 colors to be visible when illuminated



**LED Multi Color Beacons**  
available in 65mm, 45mm, and 30mm  
2 separate colors visible when illuminated  
available in various combinations in amber, red, clear, blue, green and yellow  
can choose any 2 colors combination for one unit



ONE LIGHT!  
3 color options.  
Select red, green OR yellow

**Sealed Cable for special applications**  
Individual cable lengths  
Specifications available (min. quantity required)  
Protection Class IP67



**M22 Panel Mount 3-Color Steady Beacon**  
available in 65mm and 45mm  
available in 3 colors: red, yellow and green  
One beacon provides ability for all 3 colors



# AUDIBLE AND VISUAL SIGNALING

## M22 Panel Mount Buzzer-LED Steady/Flashing Beacons

- Universally usable panel mount buzzer with LED control light
- 2 Sizes: 65mm – 45mm diameter
- Distinguishable tone types via terminal selectable (ELG)
- LED control light – high brightness, maintenance free
- PLC fit (leakage/inrush current)
- For mounting in 22.5mm and 30.5mm bore holes (with adapter)
- UL Type 4/4X/13

### Models

#### Model ELG-ELM

- Panel mount buzzer – LED control light
  - » Sound and light synchronized
  - » Continuous tone – steady light
  - » Pulsing tone – flashing light in pulse frequency
  - » Wobble tone – flashing light in pulse frequency

#### Model EDG-EDM

- Panel mount buzzer – LED control light
  - » Continuous tone and steady light separately switchable



### Panel Mount Buzzer LED Control Light ELG-ELM Alarm Tone and Light Selection via terminal

Supply Voltage			Tone output	65mm	45mm
La	N	Lb			
x	x		Pulsing Tone/LED Flashing Light	✓	✓
	x	x	Wobble Tone/LED Strobe Light (ELG)	✓	~
x	x	x	Continuous Tone/Steady Light	✓	✓

Jumper

Connect AC-Neutral to N, and AC-Line to La and/or Lb as appropriate.

### Panel Mount Buzzer LED Control Light EDG-EDM Alarm Tone and Light Selection via terminal

Supply Voltage			Tone output	65mm	45mm
La	N	Lb			
x	x		Continuous Tone	✓	✓
	x	x	Steady Light	✓	✓

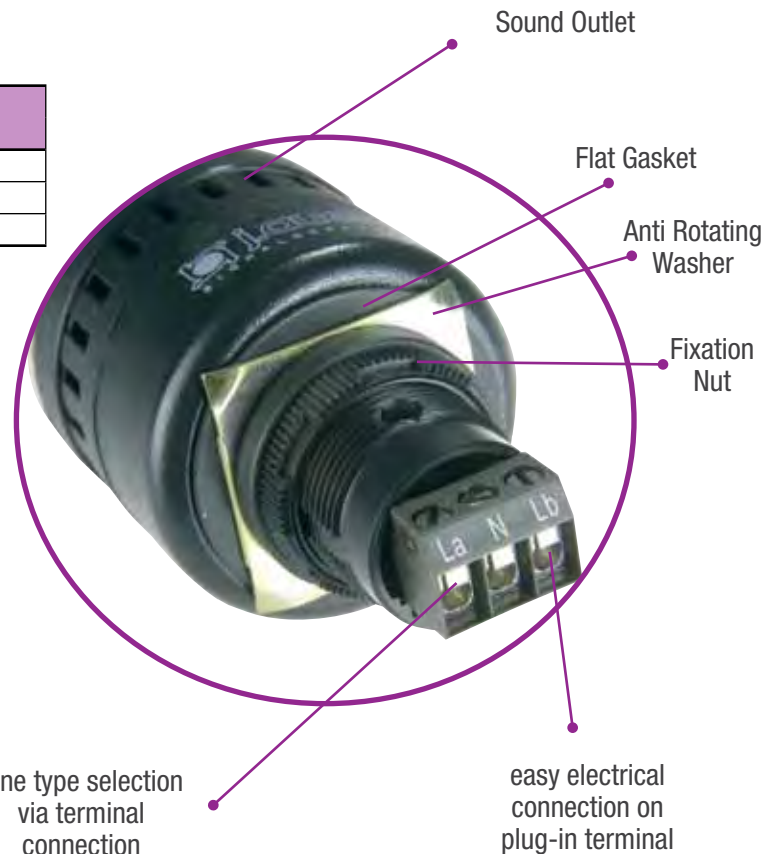

## M22 SOUNDERS



### M22 Signaling Alarms (Approximate Dimensions)

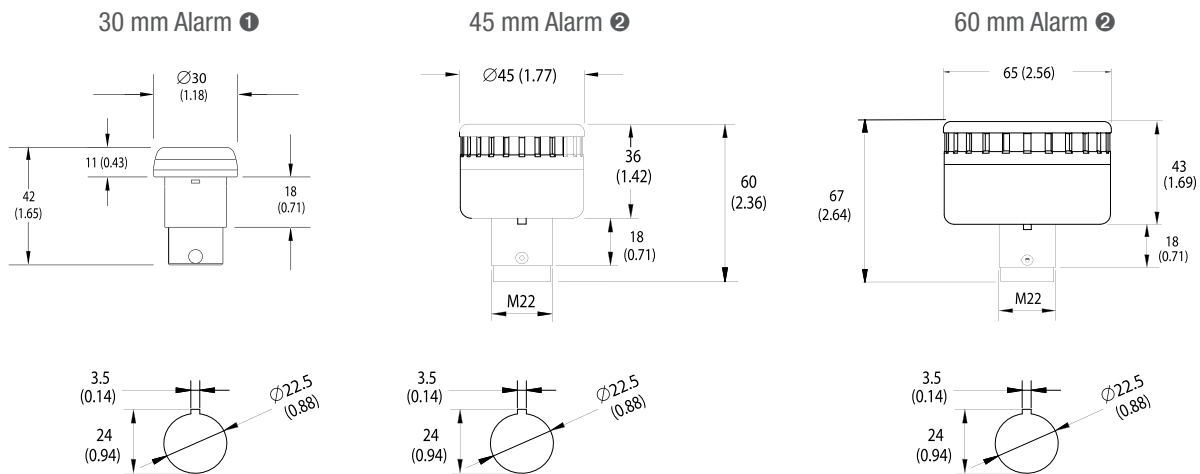

- ① Terminal connector adds 14 mm (0.55 in.) to back of panel depth.
- ② Terminal connector adds 9 mm (0.35 in.) to back of panel depth.

### Torque Rating

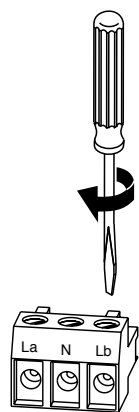

.56 N•m  
(5 lb-in)

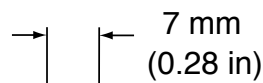

Max. 2.5 mm<sup>2</sup>  
(Max. #14 AWG)

### Panel Mounting

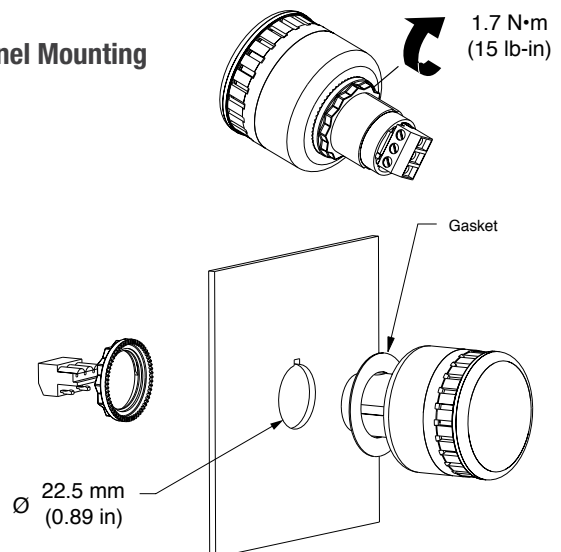

## M22 PANEL MOUNT BEACONS



allows for easy electrical connection and comfortable mounting onto panel mount beacon

## M22 PANEL MOUNT BUZZER BEACONS

