

Motor Controllers and MCCBs

Series KT9 Motor Circuit Controllers	F1.2
<i>Series KTA9 Base Units</i>	F1.4
<i>Series KTC9 Base Units</i>	F1.6
<i>Series KTB9 Base Units</i>	F1.8
<i>Series KTV9 Base Units</i>	F1.10
<i>Accessories</i>	F1.12
Series KTU9 UL489 Molded Case Circuit Breakers	F1.30
<i>Accessories</i>	F1.32
<i>Technical Information & Dimensions (Online)</i>	F1.34
Ecombo and EcomboPlus Starters	F1.40
<i>CLE8 / CLUE8 Ecombo Starters</i>	F1.42
<i>CLE7 / CLUE7 Ecombo Starters</i>	F1.44
<i>CLE+OL / CLUE+OL Three Component ECombo Starters</i>	F1.49
Enclosed KT9 Motor Controllers & Circuit Breakers	F1.56
<i>KT9 Type-E Manual Combination Controller</i>	F1.57
<i>Explosion-proof KT9 Motor Controllers</i>	F1.63
<i>KTU9 Molded Case Circuit Breakers</i>	F1.65
<i>CX7 Ecombo KWIKstarters</i>	F1.66
<i>CX7 Combination Controllers</i>	F1.73
<i>CX7 Explosion-proof Controllers</i>	F1.78
<i>CX7 Type E/F Simplex & Duplex Pump Controllers</i>	F1.79
<i>Custom Multi-Starter Control Panels</i>	F1.82
<i>Wiring Diagrams & Dimensions (Online)</i>	F1.84
Series KT5 Manual Motor Controllers	F1.89
<i>Accessories</i>	F1.91
<i>Technical Information & Dimensions (Online)</i>	F1.94

Continued . . .



Series KT7 Motor Circuit Controllers-Discontinued	F2
Series KTA7 Base Units	F4
Series KTC7 Base Units	F6
Series KTB7 Base Units	F8
Series KTV7 Base Units	F10
KF7 Fuse Holders	F19
Technical Information & Dimensions (Online)	F20
Series KTU7 UL489 Molded Case Circuit Breakers-Discontinued	F47
Accessories	F49
Technical Information & Dimensions (Online)	F51
KT7 Ecombo and EcomboPlus Starters-Discontinued	F58
CL8 / CLU8 Ecombo Starters	F60
CL7 / CLU7 Ecombo Starters	F62
CK7 / CKU7 EcomboPlus Starters	F66
Enclosed KT7 Motor Controllers & Circuit Breakers - DISCONTINUED	F88
KT7 Type-E Manual Combination Controller	F89
Explosion-proof KT7 Motor Controllers	F93
KTU7 Molded Case Circuit Breakers	F95
CX7 Combination Controllers	F105
Wiring Diagrams & Dimensions (Online)	F116
KT4 Manual Motor Starters-Discontinued	F121
Accessories	F123
Technical Information & Dimensions (Online)	F127



Series KT9 Motor Circuit Controllers

Versatile, convenient
and space saving...
for a variety of
applications

Sprecher + Schuh's KT9 Series of Motor Protection Circuit Breakers (MPCBs) or Motor Protective Switching Devices (MPSDs) are UL Listed as Manual, Self-Protected Combination Motor Controllers (Type E) and Manual Motor Controllers (with approvals for Suitable as Motor Disconnect and Suitable for use in Group Installation).

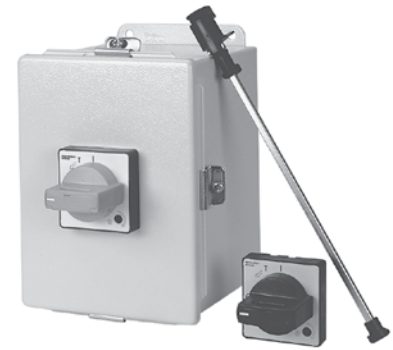

KT9s meet UL requirements for Type E manual motor controllers and "at-motor disconnects"

When UL/CSA Listed as Manual, Self-Protected Combination Motor Controllers, the KT9 Motor Protection Circuit Breakers provide all of the necessary NEC/CEC requirements for the protection and control of individual Motor Branch Circuits without additional branch circuit protective devices. According to UL 60947-4-1, CSA C22.2 No.60947-4-1, these devices may provide the following control and protection functions.

only one Branch Circuit Protective Device (BCPD) for the "Group". Series KT9 devices are also UL Listed for Tap Conductor protection in group installations, which helps reduce conductor sizing. According to UL 60947-4-1, CSA C22.2 No.60947-4-1, these devices these devices certified for group motor installation may provide the following control and protection functions.



- Disconnect for motor branch circuit
- Short-circuit Protection (magnetic protection)
- Overload protection (thermal protection)
- Manual switching (motor control means)

- Disconnect for motor branch circuit
- Overload protection (thermal protection)
- Manual switching (motor control means)

Group motor installations eliminate the need for individual branch short-circuit protective devices for each motor circuit, reducing panel space, installation and wiring time, and costs. There is

See our online white paper

Methods of Applying

KT9

Motor Circuit Controllers

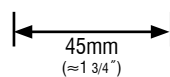

0.10...32A
Standard Interrupting Capacity

KTA9-32S

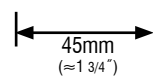

0.40...40A
High Interrupting Capacity

KTA/C9-40H

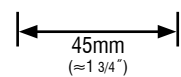

0.16...40A
High Interrupting Capacity

KT9-40H

Series KT9 devices meet requirement of Motor Protective Switching Devices (MPSD) according to IEC 60947-4-1 and Circuit Breaker according to IEC 60947-2 standard for application outside of North America. These devices provide the following functions.

- Disconnect for motor branch circuit
- Short-circuit Protection (magnetic protection)
- Overload protection (thermal protection)
- Manual switching (motor control means)

KT9 devices provide Trip Class 10 overload protection and phase loss sensitivity protection. These are suitable for single- and three- phase applications. Cat. No. KTV9 devices can also be applied at the output of a variable frequency drive (VFD) in multi-motor applications.

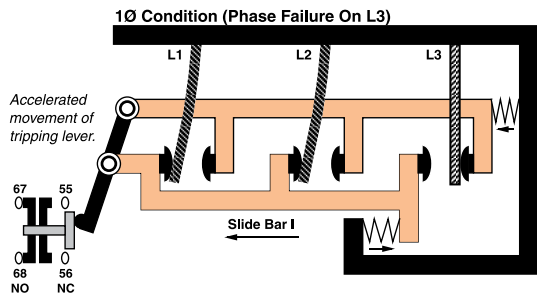

All KT9 Motor Circuit Controllers offer accelerated tripping under single phase conditions

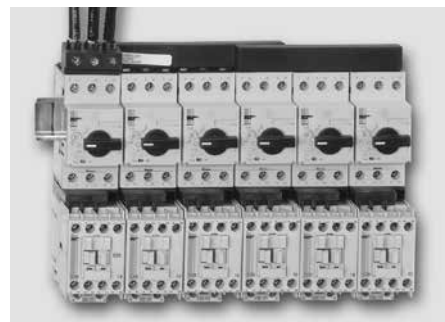
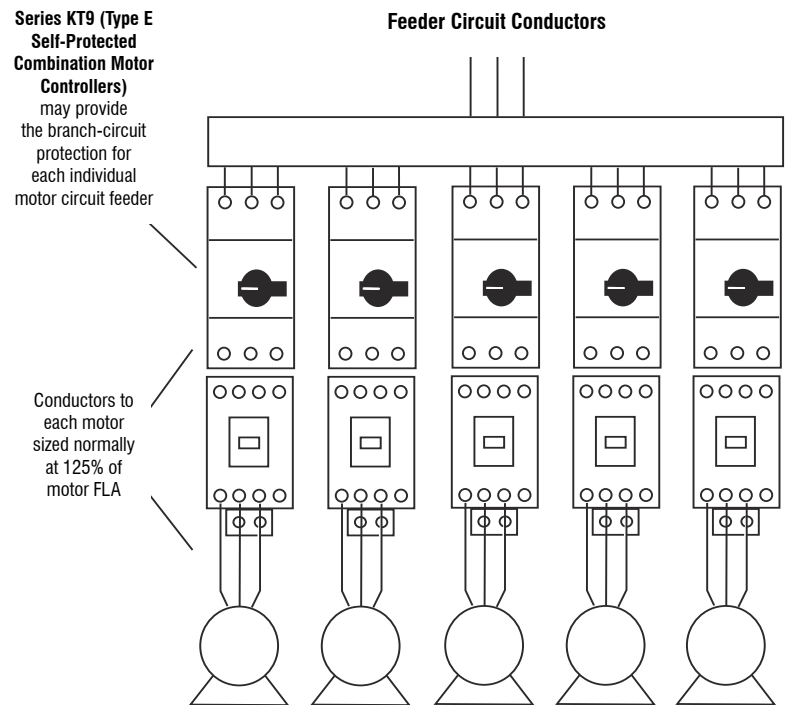
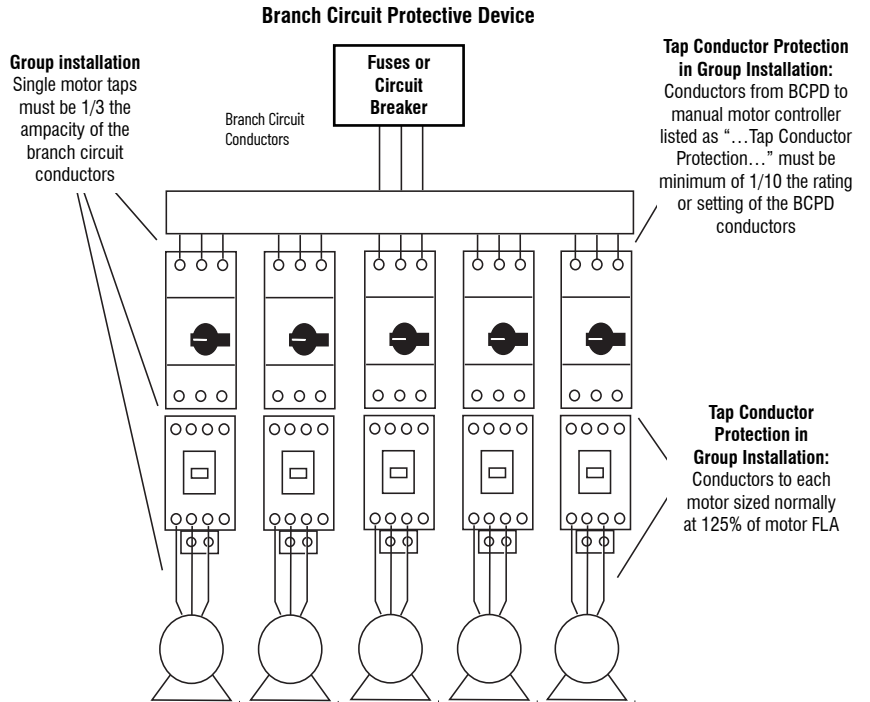

Using KT9s in Multi-Motor Starter applications can replace classic Branch Circuit Protection Devices and reduce panel space up to 60%

KTA9 Base Unit

Typical Three Phase [HP]				Current Adjustment Range [A]	Magnetic Release Response Current [A]	Catalog Number
200V	230V	460V	575V			
KTA9-32S Adjustable Thermal/Fixed Magnetic (14 x I_n)						
~	~	~	~	0.10...0.16	2.2	KTA9-32S-0.16A
~	~	~	~	0.16...0.25	3.5	KTA9-32S-0.25A
~	~	~	~	0.25...0.40	5.6	KTA9-32S-0.4A
~	~	~	~	0.40...0.63	8.8	KTA9-32S-0.63A
~	~	1/2	1/2	0.63...1.0	14	KTA9-32S-1.0A
~	~	3/4	~	1.0...1.6	22	KTA9-32S-1.6A
1/2	1/2	1	1-1/2	1.6...2.5	35	KTA9-32S-2.5A
3/4	3/4	2	3	2.5...4.0	56	KTA9-32S-4.0A
1	1-1/2	3	5	4.0...6.3	88	KTA9-32S-6.3A
2	2	5	7-1/2	6.3...10	140	KTA9-32S-10A
3	5	10	10	10...16	224	KTA9-32S-16A
5	5	10	15	14.5...20	280	KTA9-32S-20A
5	7-1/2	15	20	18...25	350	KTA9-32S-25A
7-1/2	10	20	25	23...29	406	KTA9-32S-29A
7-1/2	10	20	30	26.5...32	448	KTA9-32S-32A
KTA9-40H Adjustable Thermal/Fixed Magnetic (14 x I_n)						
~	~	~	~	0.40...0.63	8.8	KTA9-40H-0.63A
~	~	1/2	1/2	0.62...1.0	14	KTA9-40H-1.0A
~	~	3/4	~	1.0...1.6	22	KTA9-40H-1.6A
1/2	1/2	1	1-1/2	1.6...2.5	35	KTA9-40H-2.5A
3/4	3/4	2	3	2.5...4.0	56	KTA9-40H-4.0A
1	1-1/2	3	5	4.0...6.3	88	KTA9-40H-6.3A
2	2	5	7-1/2	6.3...10	140	KTA9-40H-10A
3	5	10	10	10...16	224	KTA9-40H-16A
5	5	10	15	14.5...20	280	KTA9-40H-20A
5	7-1/2	15	20	18...25	350	KTA9-40H-25A
7-1/2	10	20	25	23...29	406	KTA9-40H-29A
7-1/2	10	20	30	26.5...32	448	KTA9-40H-32A
10	10	25	30	30...36	432	KTA9-40H-36A
10	10	30	30	34...40	480	KTA9-40H-40A
KTA7-45H Adjustable Thermal/Fixed Magnetic (13 x I_n)						
2	3	5	7-1/2	6.3...10	130	KTA7-45H-10A
3	5	10	10	10...16	208	KTA7-45H-16A
5	5	10	15	14.5...20	260	KTA7-45H-20A
7-1/2	7-1/2	15	20	18...25	325	KTA7-45H-25A
7-1/2	10	20	30	23...32	416	KTA7-45H-32A
10	15	30	40	32...45	585	KTA7-45H-45A



Catalog Number KTA9-32S



Catalog Number KTA9-40H



Catalog Number KTA7-45H

F KTA9 Motor Circuit Controllers

Horsepower ratings shown in the table are for reference only. The final selection of the controller depends on the actual motor full load current and service factor.

- For motor with service factor less than 1.15. Use motor nameplate full load current times 0.9 and choose the motor starter with the appropriate current range. Example: Motor F.L.C. = 4.2A; S.F. = 1.0. - 4.2A x 0.9 = 3.78A. Select Catalog Number KTA9-32S-4.0A.

KTA9 UL Ratings Application Chart

Device	Manual Controller for Group Installation ❶		Manual Controller as Motor Disconnect ❷		Suitable for Tap Conductor Protection		Self-Protected Type E Manual Combination Controller ❸❹		
	Max. Fuse or Circuit Breaker	Max. Short Circuit Current [kA]		Max. Short Circuit Current [kA]		Max. Short Circuit Current [kA]		Max. Short Circuit Current [kA]	
		480V	600V	480V	600V	480Y/277V	600Y/347V	480Y/277V	600Y/347V
KTA9-32S — Standard Interrupting Capacity									
KTA9-32S-0.16A	450	65	50	65	50	65	50	65	50
KTA9-32S-0.25A	450	65	50	65	50	65	50	65	50
KTA9-32S-0.4A	450	65	50	65	50	65	50	65	50
KTA9-32S-0.63A	450	65	50	65	50	65	50	65	50
KTA9-32S-1.0A	450	65	50	65	50	65	50	65	50
KTA9-32S-1.6A	450	65	50	65	50	65	50	65	50
KTA9-32S-2.5A	450	65	30	65	30	65	30	65	30
KTA9-32S-4.0A	450	65	30	65	30	65	30	65	30
KTA9-32S-6.3A	450	65	30	65	30	65	~	65	~
KTA9-32S-10A	450	65	30	65	30	65	~	65	~
KTA9-32S-16A	450	30	30	30	30	30	~	30	~
KTA9-32S-20A	450	30	30	30	10	~	~	~	~
KTA9-32S-25A	450	30	18	30	5	~	~	~	~
KTA9-32S-29A	450	30	10	10	~	~	~	~	~
KTA9-32S-32A	450	30	10	10	~	~	~	~	~
KTA9-40H — High Interrupting Capacity									
KTA9-40H-0.63A	450	65	50	65	50	65	50	65	50
KTA9-40H-1.0A	450	65	50	65	50	65	50	65	50
KTA9-40H-1.6A	450	65	50	65	50	65	50	65	50
KTA9-40H-2.5A	450	65	30	65	30	65	30	65	30
KTA9-40H-4.0A	450	65	30	65	30	65	30	65	30
KTA9-40H-6.3A	450	65	30	65	30	65	30	65	30
KTA9-40H-10A	450	65	30	65	30	65	30	65	30
KTA9-40H-16A	450	30	30	65	30	65	30	65	30
KTA9-40H-20A	450	30	30	65	30	65	~	65	~
KTA9-40H-25A	450	50	30	50	30	50	~	50	~
KTA9-40H-29A	450	50	30	50	30	50	~	50	~
KTA9-40H-32A	450	50	30	30	18	30	~	30	~
KTA9-40H-36A	450	30	30	30	18	30	~	30	~
KTA9-40H-40A	450	30	30	30	18	30	~	30	~
KTA7-45H — High Interrupting Capacity									
KTA7-45H-10A	600	65	30	65	30	65	30	65	30
KTA7-45H-16A	600	65	30	65	30	65	30	65	30
KTA7-45H-20A	600	65	30	65	30	65	30	65	30
KTA7-45H-25A	600	65	30	65	30	65	30	65	30
KTA7-45H-32A	600	65	30	65	30	65	30	65	30
KTA7-45H-45A	600	65	18	65	18	65	~	65	~

- ❶ UL 508, CSA 22.2 No. 14 for group installation, in connection with short-circuit protection device.
- ❷ UL 508 Part III.
- ❸ UL 508 Part IV.
- ❹ Type E applications require use of the KT9/7-xx-TE terminal adaptor on KT9s and KT7s. Alternatively, the selection of a KT9/7 compact busbar supply block meet Type E requirements for terminal spacing.

It should be noted that the KT9/7 Manual Motor Circuit Controller, when listed as a self-protected (Type E) device, is rated for Wye-connected power systems for voltages above 240 volts (i.e. 480Y/277 volts common in the United States or 600Y/347 volts common in Canada).

F
 KT9 Motor Circuit Controllers

KTC9 Base Unit

Maximum Horsepower				Current Adjustment Range [A]	Magnetic Release Response Current [A]	Catalog Number
Typical Three Phase [HP]						
200V	230V	460V	575V			
KTC9-40H – High Interrupting Capacity						
~	~	~	~	0.10...0.16	3.2	KTC9-40H-0.16A
~	~	~	~	0.16...0.25	5.5	KTC9-40H-0.25A
~	~	~	~	0.25...0.40	8.8	KTC9-40H-0.4A
~	~	~	~	0.40...0.63	14	KTC9-40H-0.63A
~	~	1/2	1/2	0.63...1.0	22	KTC9-40H-1.0A
~	~	3/4	~	1.0...1.6	35	KTC9-40H-1.6A
1/2	1/2	1	1-1/2	1.6...2.5	55	KTC9-40H-2.5A
3/4	3/4	2	3	2.5...4	88	KTC9-40H-4.0A
1	1-1/2	3	5	4...6.3	139	KTC9-40H-6.3A
2	2	5	7-1/2	6.3...10	220	KTC9-40H-10A
3	5	10	10	10...16	320	KTC9-40H-16A
5	5	10	15	14.5...20	400	KTC9-40H-20A
5	7-1/2	15	20	18...25	450	KTC9-40H-25A
KTC7-45H — High Interrupting Capacity						
7-1/2	7-1/2	15	20	18...25	416	KTC7-45H-25A
7-1/2	10	20	30	23...32	585	KTC7-45H-32A



KTC9-40H

Description

The KTC9 has a fixed magnetic trip set at 18...22x the maximum value of the current adjustment range (as opposed to the KTA9s magnetic trip of approximately 14x adjustment range.) KTC9 are typically used in applications where nuisance tripping might occur, as with some high efficiency motors.

F

KTC9 Motor Circuit Controllers

Horsepower ratings shown in the table are for reference only. The final selection of the controller depends on the actual motor full load current and service factor.

- For motor with service factor less than 1.15. Use motor nameplate full load current times 0.9 and choose the motor starter with the appropriate current range. Example: Motor F.L.C. = 4.2A; S.F. = 1.0. – 4.2A x 0.9 = 3.78A. Select Catalog Number KTC9-40H-4.0A.

KTC9 UL Ratings Application Chart

Device	Manual Controller for Group Installation ❶		Manual Controller as Motor Disconnect ❷		Suitable for Tap Conductor Protection		Self-Protected Type E Manual Combination Controller ❸❹		
	Max. Fuse or Circuit Breaker	Max. Short Circuit Current [kA]		Max. Short Circuit Current [kA]		Max. Short Circuit Current [kA]		Max. Short Circuit Current [kA]	
		480V	600V	480V	600V	480Y/277V	600Y/347V	480Y/277V	600Y/347V
KTC9-40H — High Interrupting Capacity									
KTC9-40H-0.16A	450	65	50	65	50	65	47	65	50
KTC9-40H-0.25A	450	65	50	65	50	65	47	65	50
KTC9-40H-0.4A	450	65	50	65	50	65	47	65	50
KTC9-40H-0.63A	450	65	50	65	50	65	47	65	50
KTC9-40H-1.0A	450	65	50	65	50	65	47	65	50
KTC9-40H-1.6A	450	65	50	65	50	65	30	65	50
KTC9-40H-2.5A	450	65	30	65	30	65	30	65	30
KTC9-40H-4.0A	450	65	30	65	30	65	30	65	30
KTC9-40H-6.3A	450	65	30	65	30	65	30	65	30
KTC9-40H-10A	450	65	30	65	30	65	30	65	30
KTC9-40H-16A	450	65	30	65	18	65	30	65	~
KTC9-40H-20A	450	65	30	65	30	65	~	65	~
KTC9-40H-25A	450	50	30	50	30	50	~	50	~
KTC7-45H — High Interrupting Capacity									
KTC7-45H-25A	600	65	30	65	30	65	30	65	30
KTC7-45H-32A	600	65	18	65	18	65	18	65	18

- ❶ UL 508, CSA 22.2 No. 14 for group installation, in connection with short-circuit protection device.
- ❷ UL 508 Part III.
- ❸ UL 508 Part IV.
- ❹ Type E applications require use of the KT9/7-xx-TE terminal adaptor on KT9s and KT7s. Alternatively, the selection of a KT9/7 compact busbar supply block meet Type E requirements for terminal spacing.

It should be noted that the KT9/7 Manual Motor Circuit Controller, when listed as a self-protected (Type E) device, is rated for Wye-connected power systems for voltages above 240 volts (i.e. 480Y/277 volts common in the United States or 600Y/347 volts common in Canada).

KTB9 Base Unit ②

Maximum Horsepower				① Rated Operational Current [A]	Magnetic Release Response Current [A]	Catalog Number
Typical Three Phase [HP]						
200V	230V	460V	575V			
KTB9-40H – High Interrupting Capacity						
~	~	~	~	0.16	2.2	KTB9-40H-0.16A
~	~	~	~	0.25	3.5	KTB9-40H-0.25A
~	~	~	~	0.40	5.6	KTB9-40H-0.4A
~	~	~	~	0.63	8.8	KTB9-40H-0.63A
~	~	1/2	1/2	1.0	14	KTB9-40H-1.0A
~	~	3/4	~	1.6	22	KTB9-40H-1.6A
1/2	1/2	1	1-1/2	2.5	35	KTB9-40H-2.5A
3/4	3/4	2	3	4	52	KTB9-40H-4.0A
1	1-1/2	3	5	6.3	88	KTB9-40H-6.3A
2	2	5	7-1/2	10	130	KTB9-40H-10A
3	5	10	10	16	208	KTB9-40H-16A
5	5	10	15	20	280	KTB9-40H-20A
5	7-1/2	15	20	25	325	KTB9-40H-25A
7-1/2	10	20	25	29	406	KTB9-40H-29A
7-1/2	10	20	30	32	448	KTB9-40H-32A
10	10	25	30	36	432	KTB9-40H-36A
10	10	30	30	40	480	KTB9-40H-40A
KTB7-45H — High Interrupting Capacity						
7-1/2	10	20	25	25	325	KTB7-45H-25A
7-1/2	10	25	30	32	416	KTB7-45H-32A
10	15	30	40	45	585	KTB7-45H-45A



KTB9-40H

Description

The KTB9 is designed without a thermal trip element (i.e., current adjustment range). It should be selected for applications where a separate motor overload protection device is used, such as on CLE7 Three Component Starters on page F76. Magnetic trip is approximately 14x operational current for the KTB9 (approximately 13x for the KTB7).

F

KT9 Motor Circuit Controllers

① APPLICATION NOTE: Product Selection for Heavy Duty Starting Applications using KTB9-40H and KTB7-45H Motor Circuit Controllers

The KTB9 / KTB7 Motor Circuit Controller is designed and tested to protect a motor circuit in case of a short circuit. A separate Sprecher + Schuh CEP7 overload relay with selectable trip class should be used to protect the motor against overload.

In Applications with motor starting times exceeding 10 seconds (heavy duty starting) the rated operational current (I_e) of the motor FLA must be multiplied by the following factors for selection of the KTB9 / KTB7 Motor Circuit Controller KTB9-40H and KTB7-45H.

Trip classes according to UL 508 Section 52 and IEC 60947-4-1

CLASS 10 = 1.00 CLASS 15 = 1.22 CLASS 20 = 1.42

CLASS 25 = 1.58 CLASS 30 = 1.73

The maximum number of motor starts in 25 cycles/hour with a minimum OFF-time of 120 seconds between cycles. This additional calculation and selecting a larger frame size is necessary to compensate (dissipate) the increased heat

resulting from long acceleration applications effecting the rated operational current of the KTB9 / KTB7.

Application Example:

Motor 480 VAC, 10 HP, I_e 14 FLA

Heavy duty starting application with start time of up to 18 seconds

Solution:

Starting time up to 18 seconds requires dimensioning for CLASS 20.

- Selection of the Motor Circuit Controller for Short Circuit Protection:

Multiply the rated operational current I_e with factor for CLASS 20:

$$I_e(20) = 14 \text{ A} \times 1.42 = 19.9 \text{ A}$$

- Select corresponding Sprecher + Schuh KTB9-40H or KTB7-45H from catalog using next higher current rating: KTB9-40H-25A

② Horsepower ratings shown in the table are for reference only. The final selection of the controller depends on the actual motor full load current and service factor.

- For motor with service factor less than 1.15. Use motor nameplate full load current times 0.9 and choose the motor starter with the appropriate current range. Example: Motor F.L.C. = 4.2A; S.F. = 1.0. – (4.2A x 0.9 = 3.78A). Select Catalog Number KTB9-40H-4.0A.

KT9 UL Ratings Application Chart

Device	Manual Controller for Group Installation		Manual Controller as Motor Disconnect		Suitable for Tap Conductor Protection		
	Max. Fuse or Circuit Breaker	Max. Short Circuit Current [kA]		Max. Short Circuit Current [kA]		Max. Short Circuit Current [kA]	
		480V	600V	480V	600V	480Y/277V ❶	600Y/347V ❶
KT9-40H — High Interrupting Capacity							
KT9-40H-0.16A	450	65	50	65	50	65	50
KT9-40H-0.25A	450	65	50	65	50	65	50
KT9-40H-0.4A	450	65	50	65	50	65	50
KT9-40H-0.63A	450	65	50	65	50	65	50
KT9-40H-1.0A	450	65	50	65	50	65	50
KT9-40H-1.6A	450	65	50	65	50	65	50
KT9-40H-2.5A	450	65	30	65	30	65	30
KT9-40H-4.0A	450	65	30	65	30	65	30
KT9-40H-6.3A	450	65	30	65	30	65	30
KT9-40H-10A	450	65	30	65	30	65	30
KT9-40H-16A	450	65	30	65	30	65	30
KT9-40H-20A	450	65	30	65	30	65	~
KT9-40H-25A	450	50	30	50	30	50	~
KT9-40H-29A	450	50	30	50	30	50	~
KT9-40H-32A	450	50	30	30	18	30	~
KT9-40H-36A ❷	450	30	30	30	18	30	~
KT9-40H-40A ❷	450	30	30	30	18	30	~
KT9-45H — High Interrupting Capacity							
KT9-45H-25A	600	65	30	65	30	~	~
KT9-45H-32A	600	65	30	65	30	~	~
KT9-45H-45A	600	65	18	65	18	~	~

F
 KT9 Motor Circuit Controllers

❶ For full voltage (delta) ratings above 277V or 347V, follow the NEC or CEC rules for group motor applications.

❷ Suitable for continuous operation at 90% current rating at 480V only if used in a minimum enclosure size of 250 x 175 x 150 mm (10 x 7 x 6 in).

KTV9 Base Unit

Rated Operational Current (I _e) [A]	Current Adjustment Range [A]	Nominal Magnetic Trip Current [A]	Maximum Short Circuit Current [kA]		Maximum Horsepower Typical ①② Three Phase [HP]				Catalog Number
			480Y/277V Type E	480V (group motor)	200V	230V	460V	575V	
KTV9-40H – High Interrupting Capacity									
1.6	1.0...1.6	88	65	65	~	~	3/4	~	KTV9-40H-1.6A
2.5	1.6...2.5	88	65	65	1/2	1/2	1	~	KTV9-40H-2.5A
4.0	2.5...4.0	88	65	65	3/4	3/4	2	~	KTV9-40H-4.0A
6.3	4.0...6.3	88	65	65	1	1-1/2	3	~	KTV9-40H-6.3A
10	6.3...10	140	65	65	2	2	5	~	KTV9-40H-10A
16	10...16	224	65	65	3	5	10	~	KTV9-40H-16A
20	14.5...20	280	65	65	5	5	10	~	KTV9-40H-20A
25	18...25	350	50	50	5	7-1/2	15	~	KTV9-40H-25A
29	23...29	406	50	50	7-1/2	10	20	~	KTV9-40H-29A
32	24.5...32	448	30	50	7-1/2	10	20	~	KTV9-40H-32A
36	30...36	432	30	30	10	10	25	~	KTV9-40H-36A ③
40	34...40	480	30	30	10	10	30	~	KTV9-40H-40A ③



KTV9-40H

Description

The Sprecher+Schuh KTV9 series motor controllers are suitable for two types of applications under cULus listings:

- (1) as a Manual, Self-protected Motor Controller or
- (2) as a Manual Motor Controller with approval for group installation (and as a motor disconnect)

When UL/CSA listed as a manual, self-protected combination motor controller, the KTV9 provides all of the necessary NEC requirements for protection and control of individual motor branch circuits without additional protective devices (per NEC 430-52C option 6).

When KTV9 devices are applied as manual motor controllers in group installations, then NEC group installation rules state these devices must be applied per the appropriate rules, which require the use of an upstream BCPD-branch circuit protection device (per NEC 430-53C option 2).

The output frequency of the VFD must be limited to 400Hz or less to prevent thermal degradation. Various models of the KTV9 series self-protected combination motor controllers provide disconnection for motor branch circuits, branch-circuit and short-circuit protection (including magnetic protection), overload/thermal protection and manual switching.

The KTV9 self-protected combination motor controllers are current limiting and have a fixed magnetic trip. Interrupt ratings at 400V and 480V are available up to 65kAIC. The VFD output pulse-width modulation frequency must be limited to 4 kilohertz or less. The circuit breakers provide motor overload protection with a trip class 10 characteristic.

Horsepower ratings shown in the table are for reference only. The final selection of the controller depends on the actual motor full load current and service factor.

- For motor with service factor less than 1.15. Use motor nameplate full load current times 0.9 and choose the motor starter with the appropriate current range.
Example: Motor F.L.C. = 4.2A; S.F. = 1.0. - 4.2A x 0.9 = 3.78A.
Select Catalog Number KTV9-40H-4.0A.

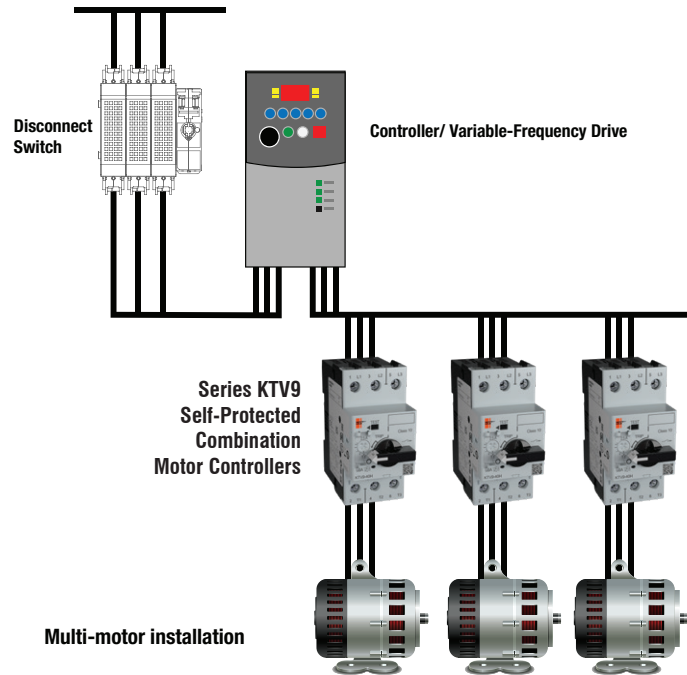

① HP ratings shown are for reference. Final selection of MPCB is determined by actual motor full load current.

② Not applicable at 575V.

③ Suitable for continuous operation at 90% current rating at 480V only if used in a minimum enclosure size of 250 x 175 x 150mm (10 x 7 x 6 in.)

KTV9 UL Ratings Application Chart

Device	Manual Controller for Group Installation		Manual Controller as Motor Disconnect		Suitable for Tap Conductor Protection		Self-Protected Type E Manual Combination Controller		
	Max. Fuse or Circuit Breaker	Max. Short Circuit Current [kA]		Max. Short Circuit Current [kA]		Max. Short Circuit Current [kA]		Max. Short Circuit Current [kA]	
		480V	600V	480V	600V	480Y/277V ❶	600Y/347V ❶	480Y/277V ❶	600Y/347V ❶
KTV9-40H — High Interrupting Capacity									
KTV9-40H-1.6A	450	65	~	65	~	65	~	65	~
KTV9-40H-2.5A	450	65	~	65	~	65	~	65	~
KTV9-40H-4.0A	450	65	~	65	~	65	~	65	~
KTV9-40H-6.3A	450	65	~	65	~	65	~	65	~
KTV9-40H-10A	450	65	~	65	~	65	~	65	~
KTV9-40H-16A	450	65	~	65	~	65	~	65	~
KTV9-40H-20A	450	65	~	65	~	65	~	65	~
KTV9-40H-25A	450	50	~	50	~	50	~	50	~
KTV9-40H-29A	450	50	~	50	~	50	~	50	~
KTV9-40H-32A	450	50	~	30	~	30	~	30	~
KTV9-40H-36A ❷	450	30	~	30	~	30	~	30	~
KTV9-40H-40A ❷	450	30	~	30	~	30	~	30	~

❶ For full voltage (delta) ratings above 277V or 347V, follow the NEC or CEC rules for group motor applications.

❷ Suitable for continuous operation at 90% current rating at 480V only if used in a minimum enclosure size of 250 x 175 x 150 mm (10 x 7 x 6 in).

Accessories for KT9





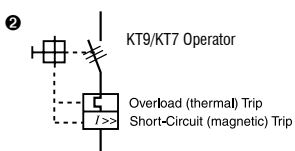





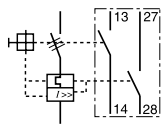

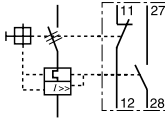

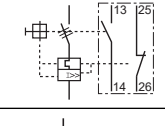

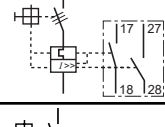
Accessory	Description	Operator Position ❶			Term. No.	Type	Connection Diagram and Terminal Markings ❷	For Use With	Catalog Number	
		OFF	ON	Tripped						
		0	X	0	13-14	1 NO		KT_9-32S KT_9-40H KTU9	KT9-PE1-10	
								KT_7-45H	KT7-PE1-10	
	Front-Mounted Auxiliary Contact • 1-pole or 2-pole • No additional space required • Only one per device. • KT9-PE1...250V max. • KT7-PE1...300V max.	X	0	X	11-12	1 NC		KT_7-45H	KT7-PE1-01	
		0	X	0	13-14	1 NO		KT_9-32S KT_9-40H KTU9	KT9-PE1-11	
		X	0	X	21-22	1 NC				
		0	X	0	13-14	1 NO				
									KT_7-45H	KT7-PE1-11
		X	0	X	21-22	1 NC				
		0	X	0	13-14	1 NO		KT_9-32S KT_9-40H KTU9	KT9-PE1-20	
		0	X	0	23-24	1 NO				
		0	X	0	13-14	1 NO				
									KT_7-45H	KT7-PE1-20
0	X	0	23-24	1 NO						
X	0	X	11-12	1 NC		KT_7-45H	KT7-PE1-02			
X	0	X	21-22	1 NC						
	Right Side-Mounted Auxiliary Contact • 2-pole • Adds 9 mm to the width of the device. • 600V max. • One per device. • Not suitable for UL489 applications	0	X	0	33-34	1 NO		KT_9-32S KT_9-40H KTU9	KT9-PA1-20	
		0	X	0	43-44	1 NO				
		0	X	0	33-34	1 NO				
									KT_7-45H	KT7-PA1-20
		0	X	0	43-44	1 NO				
		X	0	X	31-32	1 NC		KT_9-32S KT_9-40H KTU9	KT9-PA1-02	
		X	0	X	41-42	1 NC				
		X	0	X	31-32	1 NC				
									KT_7-45H	KT7-PA1-02
		X	0	X	41-42	1 NC				
		0	X	0	33-34	1 NO		KT_9-32S KT_9-40H KTU9	KT9-PA1-11	
		X	0	X	41-42	1 NC				
0	X	0	33-34	1 NO						
							KT_7-45H	KT7-PA1-11		
X	0	X	41-42	1 NC						

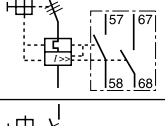
❶ X=Contact Closed
0=Contact Open

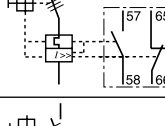

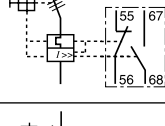
F
KT9 Motor Circuit Controllers

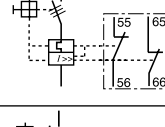
Accessories for KT9

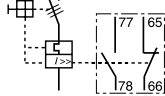

Accessory	Description	Operator Position ❶			Term No.	Type	Connection Diagram and Terminal Markings ❷	For Use With	Catalog Number							
		OFF	ON	Tripped												
 <p>Front-Mounted Trip Contact</p> <ul style="list-style-type: none"> • 2-pole • Indicates tripping of device • No additional space required • KT9-PEF1...250V max. • KT7-PEF1...300V max 	<p>0 X 0</p> <p>0 0 X</p> <p>0 X 0</p> <p>0 0 X</p> <p>X 0 X</p> <p>0 0 X</p> <p>X 0 X</p> <p>0 0 X</p> <p>0 X 0</p> <p>X X 0</p> <p>0 0 X</p> <p>0 0 X</p>	13-14	NO Aux		KT 9-32S KT 9-40H KTU9	KT9-PEF1-S10-N10										
		27-28	NO Trip (Short-Circuit & Overload)		KT 7-45H		KT7-PEF1-S10-N10									
		 <p>Right Side-Mounted Trip Contact</p> <ul style="list-style-type: none"> • 2-pole • Indicates tripping of motor protector • Adds 9 mm to the width of the device • 600V max. • Only one per device • A right-side mounted auxiliary contactor may be tandem on top of this trip contact. 	<p>0 0 X</p> <p>0 0 X</p> <p>X X 0</p> <p>X X 0</p> <p>0 0 X</p> <p>X X 0</p> <p>X X 0</p> <p>0 0 X</p> <p>X X 0</p> <p>0 0 X</p> <p>X X 0</p>	11-12	NC Aux		KT 9-32S KT 9-40H KTU9	KT9-PEF1-S10-N01								
				27-28	NO Trip (Short-Circuit & Overload)		KT 7-45H		KT7-PEF1-S10-N01							
				 <p>Right Side-Mounted Trip Contact</p> <ul style="list-style-type: none"> • 2-pole • Indicates tripping of motor protector • Adds 9 mm to the width of the device • 600V max. • Only one per device • A right-side mounted auxiliary contactor may be tandem on top of this trip contact. 	<p>0 X 0</p> <p>X X 0</p> <p>0 0 X</p> <p>0 0 X</p> <p>X X 0</p> <p>X X 0</p> <p>0 0 X</p> <p>X X 0</p> <p>0 0 X</p> <p>X X 0</p>	13-14	NO Aux		KT 9-32S KT 9-40H KTU9	KT9-PEF1-S01-N10						
						25-26	NC Trip (Short-Circuit & Overload)		KT 7-45H		KT9-PEF1-S10-M10					
						 <p>Right Side-Mounted Trip Contact</p> <ul style="list-style-type: none"> • 2-pole • Indicates tripping of motor protector • Adds 9 mm to the width of the device • 600V max. • Only one per device • A right-side mounted auxiliary contactor may be tandem on top of this trip contact. 	<p>0 0 X</p> <p>0 0 X</p> <p>X X 0</p> <p>X X 0</p> <p>0 0 X</p> <p>X X 0</p> <p>X X 0</p> <p>0 0 X</p> <p>X X 0</p> <p>0 0 X</p> <p>X X 0</p>	17-18	NO Trip (Short-Circuit & Overload)		KT 9-32S KT 9-40H KTU9	KT9-PEF1-S10-M10				
								27-28	NO Trip (Short-Circuit)		KT 7-45H		KT7-PAF1-S10-M10			
								 <p>Right Side-Mounted Trip Contact</p> <ul style="list-style-type: none"> • 2-pole • Indicates tripping of motor protector • Adds 9 mm to the width of the device • 600V max. • Only one per device • A right-side mounted auxiliary contactor may be tandem on top of this trip contact. 	<p>0 0 X</p> <p>0 0 X</p> <p>X X 0</p> <p>X X 0</p> <p>0 0 X</p> <p>X X 0</p> <p>X X 0</p> <p>0 0 X</p> <p>X X 0</p> <p>0 0 X</p> <p>X X 0</p>	57-58	NO Trip (Short-Circuit & Overload)		KT 7-45H	KT7-PAF1-S10-M01		
										67-68	NO Trip (Short-Circuit)		KT 7-45H		KT7-PAF1-S10-M01	
										 <p>Right Side-Mounted Trip Contact</p> <ul style="list-style-type: none"> • 2-pole • Indicates tripping of motor protector • Adds 9 mm to the width of the device • 600V max. • Only one per device • A right-side mounted auxiliary contactor may be tandem on top of this trip contact. 	<p>0 0 X</p> <p>0 0 X</p> <p>X X 0</p> <p>X X 0</p> <p>0 0 X</p> <p>X X 0</p> <p>X X 0</p> <p>0 0 X</p> <p>X X 0</p> <p>0 0 X</p> <p>X X 0</p>	57-58	NO Trip (Short-Circuit & Overload)		KT 7-45H	KT7-PAF1-S01/M10
												65-66	NC Trip (Short-Circuit)		KT 7-45H	
 <p>Right Side-Mounted Trip Contact</p> <ul style="list-style-type: none"> • 2-pole • Indicates tripping of motor protector • Adds 9 mm to the width of the device • 600V max. • Only one per device • A right-side mounted auxiliary contactor may be tandem on top of this trip contact. 	<p>0 0 X</p> <p>0 0 X</p> <p>X X 0</p> <p>X X 0</p> <p>0 0 X</p> <p>X X 0</p> <p>X X 0</p> <p>0 0 X</p> <p>X X 0</p> <p>0 0 X</p> <p>X X 0</p>											55-56	NC Trip (Short-Circuit & Overload)		KT 7-45H	KT7-PAF1-S01/M01
												67-68	NO Trip (Short-Circuit)		KT 7-45H	
		 <p>Right Side-Mounted Trip Contact</p> <ul style="list-style-type: none"> • 2-pole • Indicates tripping of motor protector • Adds 9 mm to the width of the device • 600V max. • Only one per device • A right-side mounted auxiliary contactor may be tandem on top of this trip contact. 	<p>0 0 X</p> <p>0 0 X</p> <p>X X 0</p> <p>X X 0</p> <p>0 0 X</p> <p>X X 0</p> <p>X X 0</p> <p>0 0 X</p> <p>X X 0</p> <p>0 0 X</p> <p>X X 0</p>									55-56	NC Trip (Short-Circuit & Overload)		KT 7-45H	KT7-PAF1-S01-M01
												65-66	NC Trip (Short-Circuit)		KT 7-45H	
				 <p>Right Side-Mounted Trip Contact</p> <ul style="list-style-type: none"> • 2-pole • Indicates tripping of motor protector • Adds 9 mm to the width of the device • 600V max. • Only one per device • A right-side mounted auxiliary contactor may be tandem on top of this trip contact. 	<p>0 0 X</p> <p>0 0 X</p> <p>X X 0</p> <p>X X 0</p> <p>0 0 X</p> <p>X X 0</p> <p>X X 0</p> <p>0 0 X</p> <p>X X 0</p> <p>0 0 X</p> <p>X X 0</p>							77-78	NO Trip (Short-Circuit)		KT 7-45H	KT7-PAF1-M11
												65-66	NC Trip (Short-Circuit)		KT 7-45H	

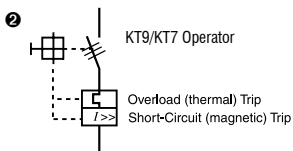
❶ X=Contact Closed
O=Contact Open



F
KT9 Motor Circuit Controllers

Accessories for KT9

Accessory	Description	For Use With	AC Coil Voltage		Catalog Number	
			50 Hz	60 Hz	Shunt Trip	Undervoltage
	<p>Undervoltage Trip</p> <ul style="list-style-type: none"> Left-side mounted Adds 18mm to the width of the device Automatically trips MPCD/MCP when voltage falls below 35...70% <p>Shunt trip</p> <ul style="list-style-type: none"> Left-side mounted Adds 18mm to width of device. Provides remote tripping of the MPCB/MCF Maximum on time for DC operated devices: 5 sec. 	KTA9 KTB9 KTC9 KTV9 KTU9 ③	24V	24...28V	KT9-AA-24V	KT9-UA-24V
			110V	120V	KT9-AA-120V	KT9-UA-120V
			220...230V	~	KT9-AA-230V	KT9-UA-230V
			~	240...260V	KT9-AA-260V	KT9-UA-260V
			~	277V	KT9-AA-277V	~
			380...400V	~	KT9-AA-400V	KT9-UA-400V
			415V	480V	KT9-AA-480V	KT9-UA-480V
			DC Coil Voltage		Shunt Trip	Undervoltage
			~	24VDC	KT9-AA-24D	~
				<p>Undervoltage Trip</p> <ul style="list-style-type: none"> Left-side mounted Adds 18 mm to the width of the KT7 device Automatically trips motor protector when voltage falls below 35...70% <p>Shunt Trip</p> <ul style="list-style-type: none"> Left-side mounted Adds 18 mm to the width of the KT7 device Trips motor protector when voltage is applied remotely 	KTA7 KTB7 KTC7	AC Coil Voltage
12V	14V	KT7-AA-14V				KT7-UA-14V
21V	24V	KT7-AA-24V				KT7-UA-24V
24V	28V	KT7-AA-28V				KT7-UA-28V
42V	48V	KT7-AA-48V				KT7-UA-48V
110V	120V	KT7-AA-120V				KT7-UA-120V
110V	127V	KT7-AA-127V				KT7-UA-127V
220...230V	~	KT7-AA-230V				KT7-UA-230V
~	240...260V	KT7-AA-240V				KT7-UA-240V
240V	277V	KT7-AA-277V				KT7-UA-277V
380V	460V	KT7-AA-460V				KT7-UA-460V
415V	480V	KT7-AA-480V				KT7-UA-480V
525V	600V	KT7-AA-600V				KT7-UA-600V
DC Coil Voltage		Shunt Trip				Undervoltage
9V DC		KT7-AA-9D				KT7-UA-9D
12V DC		KT7-AA-12D				KT7-UA-12D
24V DC		KT7-AA-24D				KT7-UA-24D
36V DC		KT7-AA-36D				KT7-UA-36D
48V DC		KT7-AA-48D				KT7-UA-48D
60V DC		KT7-AA-60D	KT7-UA-60D			
64V DC		KT7-AA-64D	KT7-UA-64D			
72V DC		KT7-AA-72D	KT7-UA-72D			
80V DC		KT7-AA-80D	KT7-UA-80D			

F

KT9 Motor Circuit Controllers

Undervoltage Trip Connection Diagram

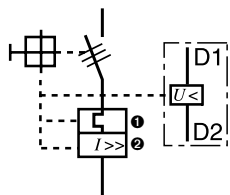

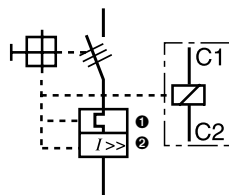

Shunt Trip Connection Diagram





- ① For Overload (thermal) Trip of KT9/KT7.
- ② For Short-Circuit (magnetic) Trip of KT9/KT7.
- ③ (UL 489 application up to 30 A)



Classic Handle Assembly, Type 1/4/4X/12

Accessory	Description	Color	Legend	For use with...	Frame Size (Length)	Catalog Number
	Classic Door Coupling Handle <ul style="list-style-type: none"> For 3 padlocks 4...8 mm (5/16") diameter Type 1/3/3R/4/4X/12 and IP66 Interlock override capability Can be modified for locking in ON position Ships with coupling — order extension shaft and legend plate separately See Technical Section for mounting depth information 	Gray/Black	0 - I OFF - ON Trip	KT_9-32S, KT_9-40H, KTU9	65 x 65mm	KT9-HTN
				KT_7-45H		KT7-HTN
		Red/Yellow	0 - I OFF - ON Trip	KT_9-32S, KT_9-40H, KTU9	65 x 65mm	KT9-HTRY
				KT_7-45H		KT7-HTRY
	Extension Shaft <ul style="list-style-type: none"> Cut to required length for mounting depth (front of DIN Rail to front of enclosure door) See Technical Section for mounting depth information 			KT9-HTN KT9-HTRY	250 mm	KT9-HT
		KT7-HTN KT7-HTRY	KT7-HT			
		KT9-HTN KT9-HTRY	400 mm	KT9-HTL		
		KT7-HTN KT7-HTRY		KT7-HTL		

Contemporary Handle Assembly, Type 3R/3/4/4X

Accessory	Description	Color	Legend	For use with...	Frame Size (Length)	Catalog Number
	Contemporary Door Coupling Handle <ul style="list-style-type: none"> Screw Fixing Type 3R, 3, 12, 4, 4X, IP66 Field configurable for defeatable or non-defeatable Ships with coupling — order extension shaft and legend plate separately Requires 30mm hole for mounting For up to 2 padlocks 	Black/Black	0 - I OFF - ON Trip	KT_9-32S, KT_9-40H, KTU9	48.7 x 47mm	KT9-SB
				KT_7-45H		KT7-SB
		Red/Yellow	0 - I OFF - ON Trip	KT_9-32S, KT_9-40H, KTU9	48.7 x 47mm	KT9-SY
				KT_7-45H		KT7-SY
	Extension Shaft <ul style="list-style-type: none"> Cut to required length for mounting depth (front of DIN Rail to front of enclosure door) See Technical Section for mounting depth information 			KT9-SB KT9-SY	305mm (12")	KT9-S1
		KT7-SB KT7-SY	KT7-S1			
		KT9-SB KT9-SY	533mm (21")	KT9-S2		
		KT7-SB KT7-SY		KT7-S2		

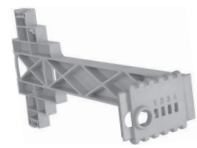





Handle Accessories

Accessory	Description	For use with...	Catalog Number
	Coupler <ul style="list-style-type: none"> Coupler for extension shaft Included with KT9-HTN/HTRY and KT9-SB/SY handles 	KTA9-32S, KT_9-40H KTU9-40H	KT9-DNC
	Extension Shaft Support <ul style="list-style-type: none"> Provides consistent alignment of the shafts with handle or door coupling Recommended for shaft lengths >200mm (7.8 in) 9mm in width and snaps on right side of devices Allows for one side-mount auxiliary 	KT_9-32S, KT_9-40H, KTU9	KT9-SHS
		KT_7-45H	KT7-SHS
	Legend Plate <ul style="list-style-type: none"> Marking: "Hauptschalter" and "Main Switch" (Black/Gray) Marking: "Not-Aus" and "Emergency Off" (Black/Yellow) 	KT9-HT_	KT9-HTFCN
		KT7-HT_	KT7-HTFCN
		KT9-HT_	KT9-HTFCRY
		KT7-HT_	KT7-HTFCRY

① See Dimensions and Technical data in this section for design compatibility.

② See page F41 for assembly example and dimensions.

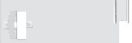
Accessories for KT9

Accessory	Description	Color	For Use With	Catalog Number	
  	Lockable Twist Knob <ul style="list-style-type: none"> For 1 padlock 4...6 mm (3/16 in.) diameter shackle Can be locked in OFF position 	Black	KT_9-32S, KT_9-40H, KTU9	KT9-KN	
			KT_7-45H	KT7-KN1	
	Locking Tag <ul style="list-style-type: none"> Padlock attachment to the lockable handles Up to three padlocks 4...8 mm (5/16 in.) dia. shackle 	Red/Yellow	KT_9-32S, KT_9-40H, KTU9	KT9-KRY	
			KT_7-45H	KT7-KRY1	
		Locking Tag <ul style="list-style-type: none"> Padlock attachment to the lockable handles Up to three padlocks 4...8 mm (5/16 in.) dia. shackle 	Red	KT9-KN KT9-KRY1	KT9-M3
				KT7-KN1 KT7-KRY1	KT7-DS
	Terminal Adapter for Type E Applications ⓘ <ul style="list-style-type: none"> Required for self-protected combination motor controller (Type E) application of KT_9-32S, KT_9-40H and KT_7-45H Not for use with bus bars 		KT_9-32S, KT_9-40H	KT9-40-TE	
			KT_7-45H	KT7-45-TE	
	Anti-Tamper Shield <ul style="list-style-type: none"> Provides protection against inadvertent adjustment of the current setting Sold only in packages of 10. Order 10 pieces to receive 1 pkg. of 10 		KT_9-32S, KT_9-40H	KT9-CA	
			KT_7-45H	KT7-25-CA	
	Screw Adaptor <ul style="list-style-type: none"> For screw fixing of motor protection circuit breaker Sold only in packages of 10. Order 10 pieces to receive 1 pkg. of 10 		KT_9-32S, KT_9-40H, KTU9	KT9-N45	
			KT_7-45H	KT7-45-AS	

F KT9 Motor Circuit Controllers

Marking Systems

Component	Description	Pkg. Qty.	Catalog Number
	Label Sheet - 1 sheet with 105 self-adhesive paper labels each, 6 x17mm	1	CA7-FMS

ⓘ Terminal Adaptors are supplied as standard on enclosed KT9 and CX7 starters, as well as, CLE- assembled products, assuring they can be used in Type E applications. Alternatively, compact busbar supply block KT9- _A2E or -A3E meet Type E requirements for terminal spacing.

Connecting Modules (for connecting KTA7, KTB7 or KTC7 into KT_9 to CA8, CA7 AC coil, or CA7 Electronic DC coil contactors) ②

Module	Type	Description	For Connecting	Catalog Number ①
	ECO Connection Module 12A (IEC) , 11A (UL)	<ul style="list-style-type: none"> For DOL and reversing starters Eco-starters mount on single DIN Rail (KT_9 on DIN Rail) Electrical and mechanical interconnection of KT_9 and CA8 contactors 	KT_9-32S to CA8	KT9-32S-PEK12
	ECO Connection Module 25A (IEC) , 22A (UL)	<ul style="list-style-type: none"> Eco-starters mount on single DIN Rail (KT_9 on DIN Rail) Electrical and mechanical interconnection of KT_9 MPCB and CA7 (with AC coils or 24V DC electronic coils) contactors 	KT_9-32S to CA7-9...23	KT9-32S-PEC23
	ECO Connection Module 38A (IEC) , 34A (UL)		KT_9-40H to CA7-9...23	KT9-40H-PEC23
	ECO Connection Module KT9-...-PNC23 25A (IEC), 24A (UL) KT9-...-PNC37 38A (IEC), 34A (UL)	<ul style="list-style-type: none"> Contactor and MPCB MUST BE mounted separately on (2) DIN Rails Electrical interconnection of KT_9 and CA7 (with AC coils) 	KT_9-32S to CA7-9...23	KT9-32S-PNC23
	Connecting Modules — 25 and 45 A		KT_9-40H to CA7-9...23	KT9-40H-PNC23
			KT_9-40H to CA7-30...37	KT9-40H-PNC37
		<ul style="list-style-type: none"> Contactor and MPCB MUST BE mounted separately on (2) DIN Rails Electrical Interconnection of KT_7-45H and CA7 (with AC coils) 	KT_7-45H to CA7-30...37	KT7-45H-PNC37
		KT_7-45H to CA7-43	KT7-45H-PNC43	

Coil Modules

	Coil Extension Modules	<ul style="list-style-type: none"> Provides access to coil terminals on 3-component starters 	CA7-9...23	KT9-32S-PSC23
			CA7-30...55	KT9-80H-PSC43
			CA7-30...55	KT7-45H-PSC43

Type W Mounting Modules

Module	Description	Width (mm)	Catalog Number
	Short Mounting Module - Requires Connecting Module from tables above <ul style="list-style-type: none"> Provides support for KT7 + CA7 or CA8 Top rail is specifically designed for KT7 Bottom rail is movable for easy assembly and disassembly Complete unit mounts to two 35mm DIN-rails or one 70mm DIN-rail or screw mounts 228 mm long 	45	W-32489
		54	W-32490
	Long Mounting Module - See Section D for Connecting Modules <ul style="list-style-type: none"> Provides support for KT7 + PCS Softstarter, CA7 + PCS Softstarter or KTB7 + CA7+CEP7 Top rail is specifically designed for KT7 Bottom rail is movable for easy assembly and disassembly Complete unit mounts to two 35mm DIN-rails or one 70mm DIN-rail or screw mounts 283 mm long 	45	W-32496
		54	W-32497

① cURus Approved (File # E33916).

② Not for use with KTU9 Circuit Breakers

Compact Busbar System for KT_9 Motor Controllers ①

Accessory	Description	For Use With	Catalog Number
	<p>Compact Busbar — 45 mm Spacing (Rated 64 A)</p> <ul style="list-style-type: none"> For use with front-mounted auxiliary contact on KT_9 Motor Controllers Connects 2 Motor Controllers Connects 3 Motor Controllers Connects 4 Motor Controllers Connects 5 Motor Controllers 	KTA9-32S, KT_9-40H, KTU9	<p>KT9-40-DB-45-2</p> <p>KT9-40-DB-45-3</p> <p>KT9-40-DB-45-4</p> <p>KT9-40-DB-45-5</p>
	<p>Compact Busbar — 54 mm Spacing (Rated 64 A)</p> <ul style="list-style-type: none"> For use with side-mounted auxiliary contact on KT_9 Motor Controllers Connects 2 Motor Controllers Connects 3 Motor Controllers Connects 4 Motor Controllers Connects 5 Motor Controllers 	KTA9-32S, KT_9-40H, KTU9	<p>KT9-40-DB-54-2</p> <p>KT9-40-DB-54-3</p> <p>KT9-40-DB-54-4</p> <p>KT9-40-DB-54-5</p>
	<p>Compact Busbar — 54mm Spacing (Rated 115 A)</p> <ul style="list-style-type: none"> For use with front-mounted auxiliary contact on KT_7 Motor Controllers Connects 2 Motor Controllers Connects 3 Motor Controllers Connects 4 Motor Controllers 	KT_7-45H	<p>KT7-45-DB-54-2</p> <p>KT7-45-DB-54-3</p> <p>KT7-45-DB-54-4</p>
	<p>Compact Busbar — 63 mm Spacing (Rated 115 A)</p> <ul style="list-style-type: none"> For use with side-mounted auxiliary contact on KT_7 Motor Controllers Connects 2 Motor Controllers Connects 3 Motor Controllers Connects 4 Motor Controllers 	KT_7-45H	<p>KT7-45-DB-63-2</p> <p>KT7-45-DB-63-3</p> <p>KT7-45-DB-63-4</p>
<p>KTA9-32S to 40H KT9-KBH</p>	<p>Top Hat Rail Adapter — 10 mm</p> <ul style="list-style-type: none"> Adjust the depth of the KTA9-32S to the KT_9-40H Allows the use of compact busbars across both frame sizes Must be ordered in multiples of 10 Sold only in packages of 10. Order 10 pieces to receive 1 pkg. of 10 	KTA9-32S	KT9-KBH
<p>KT9-40-A2E</p>	<p>Feeder Block for Compact Busbar</p> <ul style="list-style-type: none"> Supply of compact busbars Increases terminal capacity 	KTA9-32S	KT9-40-A2E
		KT_7-45H	KT7-45-A2E
<p>KT9-40-A3E</p>	<p>Feeder Terminal for Compact Busbar</p> <ul style="list-style-type: none"> For supply of compact busbars Top feed — overlaps compact busbar Meets UL Type E spacing requirements 	KTA9-32S, KT_9-40H	KT9-40-A3E
		KT_7-45H	KT7-45-A3E
	<p>Terminal Cover</p> <ul style="list-style-type: none"> For covering of unused compact bus bar terminals IP2X finger protection Must be ordered in multiples of 10 Sold only in packages of 10. Order 10 pieces to receive 1 pkg. of 10 	KT9-40-DB	KT9-40-DBA
		KT7-45-DB	KT7-45-DBA

F KT9 Motor Circuit Controllers

① UL Approved (File #E33916); CSA Approved (File #13908).

General Data







Attribute	KT9-32S	KT9-40H	KT7-45H		
Standards compliance	IEC	IEC/EN 60947-2, IEC/EN 60947-4-1			
	cULus ①	UL 60947-4-1, CSA C22.2, No. 60947-4-1			
Certifications	Regional ①	CCC, EAC, CE, IEC, cULus Listed	cULus Listed, CCC, EAC, CE		
Rated Insulation Voltage U_i	IEC [V]	690			
	UL/CSA [V]	600			
Rated Impulse Withstand Voltage U_{imp}	Pollution degree				
	3				
	Main circuits U_{imp} /Overvoltage Category		6 kV/III, 8 kV (Disconnect)		
Auxiliary circuits U_{imp} /Overvoltage Category		6 kV/III			
Rated Frequency	[Hz]	45-65			
Utilization Category	IEC 60947-2 (Circuit breaker)		A		
	IEC 60947-4-1 (Motor starter)		AC-3		
Life Span	Mechanical [operations]	100,000	30,000		
	Electrical (I_e max.) [operations]	100,000	30,000		
Switching Frequency	[operations/hours]	max. 25			
Ambient Temperature	Storage [°C (°F)]	-40...+85°C (-40-185°F)			
	Operation [°C (°F)]	-25...+70°C (-13-158°F)			
Climatic resistance	Operating Humidity/Moisture heat (60068-2-3)	5...95% Non-condensing			
Site Altitude	[m]	to 2000 N.N. (6561 ft)			
Protection Class		IP2X from all directions			
Resistance to Shock, Transport (60068-2-27)	ON	15 G/11 ms			
	OFF	30 G/11 ms			
Resistance to Vibration, Operation (60068-2-6)		5 G			
Rated Thermal Current I_m	up to 40 °C (104 °F) ambient temperature	[A]	0.1...32	0.63...40	6.3...45
	up to 60 °C (140 °F) ambient temperature	[A]	0.1...32	0.63...40	6.3...45
Rated Supply Current I_e		[A]	0.1...32	0.63...40	6.3...45
Dependence on Temperature	40 °C (104 °F)	[A]	no reduction		
	50 °C (122 °F)	[A]	no reduction		
	60 °C (140 °F)	[A]	no reduction		
	70 °C (158 °F)	[A]	15% current reduction of the upper rated current I_e		
Overload Protection Characteristics		IEC 60947-4-1 Motor protection (except Cat. Nos. KTB9-40H, KTB7-45H)			
Ambient Temperature Compensation	[°C (°F)]	-25...+60 (-13...+140)			
Phase-loss Protection		Differential release			
Trip class		10 (except Cat. Nos. KTB9-40H, KTB7-45H) fixed setting			
Magnetic Release		fixed setting			
Release current ($\pm 20\%$)	for KTA9, KTB9	[A]	14 x I_e max. ②	13 x I_e max.	
	for KTA9, KTB9 36A, 40A	[A]	12 x I_e max. ②	~	
	for KTC9	[A]	18...22 x I_e max. ③		
Total Power loss P_v	Circuit Breaker at rated load/operating temp.	[W]	4...11	4...14	7...22
Main Disconnect Switch Application		Yes, with accessories			
Application Conditions	KT_9-40H...36A, -40A: Suitable for continuous operation at 90% current rating at 480V only if used in a minimum enclosure size of 250 x 175 x 150 mm (10 x 7 x 6 in).				
	For utilization outside North America, assemblies (of products) shall comply to the IEC 61439-1 requirements KT9 manual starters are intended for use in closed areas without hazardous operating conditions such as dust or explosive or corrosive gases. Enclosures of appropriate manner need to be in place to protect devices in such environments.				

① cULus Listing in process.

② I_e max. = maximum values of setting ranges fixed magnetic setting for KTV9-40H; see ratings.

③ I_e max. = maximum values of setting ranges; see ratings.

MPCB Connecting Characteristics

Connection	No. of conductors	KTA9-32S	KT_9-40H	KT_7-45H
Power Terminals				
Terminal Type		Screw Clamp up to 16 A, M4	Screw Clamp greater than 16 A, M4	
Screwdriver		Pozidriv No.2/Blade No.3	Pozidriv No.2/Blade No.3	Pozidrive No. 2/Blade No. 3
Solid or stranded 	1 conductor	1...6 mm ²	1.5...10 mm ²	2.5...25 mm ²
	2 conductor	1...2.5 mm ² 2.5...6 mm ²	1.5...4 mm ² 4...10 mm ²	2.5...25 mm ²
Flexible with ferrule (end sleeve) 	1 conductor	1...6 mm ²	1.5...10 mm ²	2.5...25 mm ²
	2 conductor	1...2.5 mm ² 2.5...4 mm ²	1.5...4 mm ² 4...10 mm ²	2.5...25 mm ²
Finely stranded 	1 conductor	1.5...6 mm ²	2.5...10 mm ²	16...25 mm ²
	2 conductor	1.5...4 mm ² 2.5...6 mm ²	2.5...6 mm ² 4...10 mm ²	16...25 mm ²
Cross section per UL/CSA solid, stranded 	1 conductor	No. 14...10 AWG	No. 14...8 AWG	No.14...8
	2 conductor	No. 14...10 AWG	No. 14...10 AWG No. 12...8 AWG	No.14...8
Stripping length		10 mm (0.39 in.)	10 mm (0.39 in.)	10 mm (0.39 in.)
Tightening torque	[Nm]/[lb-in.]	2...2.5 / 18...22	2...2.5/18...22	3...3.5 / 27...30

Approval Comparison



KTA9-32S



KT_9-40H



KT_7-45H

Features and Approvals

Max. Current I_n	32 A	32 A	45 A
Current Rating	0.1...32 A	0.63...40A	6.3...45 A
Short Circuit Protection	✓	✓	✓
Standard magnetic Trip	✓	✓	✓
High Magnetic Trip	✓	✓	✓
Magnetic Only Trip (MCP)	✓	✓	✓
Overload Protection	✓	✓	✓
Trip Class	✓	✓	✓
Application at output of VFD (multi-motor)		✓ (KTV9)	✓
Standards Compliance:			
CSA22.2, No. 14	✓	✓	✓
UL508 (Group Installation)	✓ (see ratings)	✓ (see ratings)	✓ (see ratings)
UL508 Manual, Self-protected (Type E)	✓ (see ratings)	✓ (see ratings)	✓ (see ratings)
UL508 (Overload Protection)	✓	✓	✓
IEC60947-1,-2	✓	✓	✓
IEC60947-4-1	✓	✓	✓
CE	✓	✓	✓
ATEX (IEC60079-14)	✓ (up to 25 A)	✓ (up to 25 A except KTV9)	✓
CCC	✓ (up to 25 A)	✓ (up to 25 A except KTV9)	✓
Accessories			
External Rotary Operator	✓	✓	✓
Auxiliary Contacts	✓	✓	✓
Trip Indicator Contacts	✓	✓	✓







Auxiliary Contact Specifications – for KTA9-32S... and KT_9-40H devices

Attribute		Front-mounted Auxiliary Contacts Cat. Nos. KT9-PE1, -PEF1/ -PEF1-S10M10		Right Side-mounted Auxiliary Contacts Cat. No. KT9-PA1
Rated Thermal Current I_{th}	at 40°C (104°F) ambient temperature	[A]	5	10
	at 60°C (140°F) ambient temperature	[A]	4	6
Back-up Fuses gG, gL		[A]	10	10
General Use current		[A]	5	10
Rated insulation voltage U_i	IEC	[V]	250	690
	UL/CSA	[V]	240	600
Contact rating code designation (UL/CSA)	AC		B300	A600
	DC		R300	Q600
Rated Supply Current I_e	AC-15	24V [A]	4	6
		120V [A]	3	5
		240V [A]	1.5	3
		415V [A]	-	2
		690V [A]	-	1
	DC-13	24V [A]	1.2	2
		125V [A]	0.22	0.55
		250V [A]	0.11	0.27
		400V [A]	-	0.15
		500V [A]	-	0.13
Type of Terminals				
Recommended Screwdriver			Pozidrive No. 2/Blade No. 3	Pozidrive No. 2/Blade No. 3
	Flexible with insulated ferrule	1 or 2 conductors	0.5...1.5 mm ² /No. 18...14 AWG	0.5...2.5 mm ² /No. 18...14 AWG
	Flexible	1 or 2 conductors	0.5...1.5 mm ² /No. 18...14 AWG	0.75...2.5 mm ² /No. 18...14 AWG
	Stranded per UL/CSA	1 or 2 conductors	0.5...1.5 mm ² /No. 18...14 AWG	0.75...2.5 mm ² /No. 18...14 AWG
	Solid	1 or 2 conductors	0.5...1.5 mm ² /No. 18...14 AWG	0.5...2.5 mm ² /No. 18...14 AWG
Conductor steps			Max 2 conductor steps allowed	Max 2 conductor steps allowed
Tightening torque			1...1.2 N•m/8.9...10.6 lb•in	1...1.2 N•m/8.9...10.6 lb•in/1...1.2

Auxiliary Contact Specifications – for KT_7-45H... devices

Attribute		Front-mounted Auxiliary Contacts Cat. Nos. 140M-C-AFA..., 140M-C-AFAR...		Right Side-mounted Auxiliary Contacts Cat. Nos. 140M-C-ASA..., 140M-C-ASAR...
Rated Thermal Current I_{th}	at 40°C (104°F) ambient temperature	[A]	5	10
	at 60°C (140°F) ambient temperature	[A]	4	6
Back-up Fuses gG, gL		[A]	10	10
Contact rating code designation (UL/CSA)	AC		B300	A600
	DC		R300	Q600
Rated Supply Current I_e	AC-15	24V [A]	4	6
		120V [A]	3	5
		240V [A]	1.5	3
		415V [A]	-	2
		690V [A]	-	0.7
	DC-13	24V [A]	2	2
		120V [A]	0.5	0.5
		240V [A]	0.25	0.25
		415V [A]	-	0.15
Type of Terminals				
Recommended Screwdriver			Pozidriv No. 2/Blade No.3	Pozidriv No. 2/Blade No.3
	Flexible with insulated ferrule	1 conductor	0.5...1.5 mm ²	0.5...2.5 mm ²
		2 conductors	0.75...1.5 mm ²	0.75...2.5 mm ²
	Stranded per UL/CSA	1 or 2 conductors	0.75...1.5 mm ² /No. 18...14 AWG	0.75...2.5 mm ² /No. 18...14 AWG
	Solid	1 or 2 conductors	0.75...1.5 mm ² /No. 18...14 AWG	0.75...2.5 mm ² /No. 18...14 AWG
Tightening torque			1...1.2 N•m/8.9...10.6 lb•in	1...1.2 N•m/8.9...10.6 lb•in/1...1.2

Undervoltage and Shunt Trip Specifications—For KTA9-32S... and KT_9-40H... devices

Actuating Voltage		Undervoltage Trip for Left-Side Mounting Cat. Number KT9-UA-*		Shunt Trip for Left-Side Mounting Cat. Number KT9-AA-*		
		Pull-in Drop-out	0.85...1.1 x U_s 0.7...0.35 x U_s	0.7...1.1 x U_s 0.7...1.1 x U_s		
Rated AC Control Voltage	KT9-UA-24V	50 Hz 60 Hz	24 28	-	-	
	KT9-UA-120V	50 Hz 60 Hz	110 120	-	-	
	KT9-UA-230V	50 Hz 60 Hz	220...230 -	-	-	
	KT9-UA-260V	50 Hz 60 Hz	- 240...260	-	-	
	KT9-UA-400V	50 Hz 60 Hz	380...400 440...460	-	-	
	KT9-UA-480V	50 Hz 60 Hz	415 480	-	-	
	KT9-AA-24V	50 Hz 60 Hz	- -	24 24...28		
	KT9-AA-120V	50 Hz 60 Hz	- -	110 120		
	KT9-AA-230V	50 Hz 60 Hz	- -	220...230 -		
	KT9-AA-260V	50 Hz 60 Hz	- -	- 240...260		
	KT9-AA-277V	50 Hz 60 Hz	- -	240 277		
	KT9-AA-400V	50 Hz 60 Hz	- -	380...400 440...460		
	KT9-AA-480V	50 Hz 60 Hz	- -	415 480		
	On-time		Continuous duty	Continuous duty		
	Coil consumption		8.5/8 4/2	8.5/8 4/2		
	Rated DC Control Voltage	KT9-AA-24D		-	24	
		On-time		-	Max 5 s	
		Coil consumption Pick-up		-	50	
	Type of Terminals					
	Recommended screwdriver			PozIDRIVE No. 2/BLADE No. 3	PozIDRIVE No. 2/BLADE No. 3	
Flexible with insulated ferrule		1 or 2 conductor	0.5...2.5 mm ² / No. 18...14 AWG	0.5...2.5 mm ² / No. 18...14 AWG		
Flexible		1 or 2 conductor	0.75...2.5 mm ² / No. 18...14 AWG	0.75...2.5 mm ² / No. 18...14 AWG		
Stranded per UL/CSA		1 or 2 conductor	0.75...2.5 mm ² / No. 18...14 AWG	0.75...2.5 mm ² / No. 18...14 AWG		
Solid		1 or 2 conductor	0.5...2.5 mm ² / No. 18...14 AWG	0.5...2.5 mm ² / No. 18...14 AWG		
Conductor steps			Max 2 conductor steps allowed	Max 2 conductor steps allowed		
Tightening torque			1...1.2 N•M/8.9...10.6 LB•IN	1...1.2 N•M/8.9...10.6 LB•IN	1...1.2	

F
KT9 Motor Circuit Controllers

Undervoltage and Shunt Trip Specifications – For KT_7-45H... devices

Attribute		Undervoltage Trip for Left-Side Mounting Cat. Number KT7-UA-*		Shunt Trip for Left-Side Mounting Cat. Number KT7-AA-*		
Actuating Voltage	Pick-up	[V]	0.85...1.1 x U _s	0.7...1.1 x U _s		
	Drop-out	[V]	0.7...0.35 x U _s	0.7...1.1 x U _s		
Rated AC Control Voltage	Min	50 Hz	[V AC]	21	21	
		60 Hz	[V AC]	24	24	
	Max	60 Hz	[V AC]	600	600	
		On-time	Continuous duty		Continuous duty	
Coil consumption	Pick-up	[VA/W]	8.5/8	8.5/8		
	Hold-in	[VA/W]	4/2	4/2		
Type of Terminals						
Recommended Screwdriver			Pozidrive No. 2/Blade No. 3		Pozidrive No. 2/Blade No. 3	
	Flexible with insulated ferrule	1 conductor	0.5...2.5 mm ²		0.5...2.5 mm ²	
		2 conductors	0.75...2.5 mm ²		0.75...2.5 mm ²	
	Stranded per UL/CSA	1 or 2 conductors	0.75...2.5 mm ² /No. 18...14 AWG		0.75...2.5 mm ² /No. 18...14 AWG	
	Solid	1 or 2 conductors	0.75...2.5 mm ² /No. 18...14 AWG		0.75...2.5 mm ² /No. 18...14 AWG	
Conductor steps			1.2...1.5 N•m/10.6...13.3 lb•in		1.2...1.5 N•m/10.6...13.3 lb•in	

Time-Current Characteristic

KT9 KTA7 Motor Protection (for KTV9, see ratings)

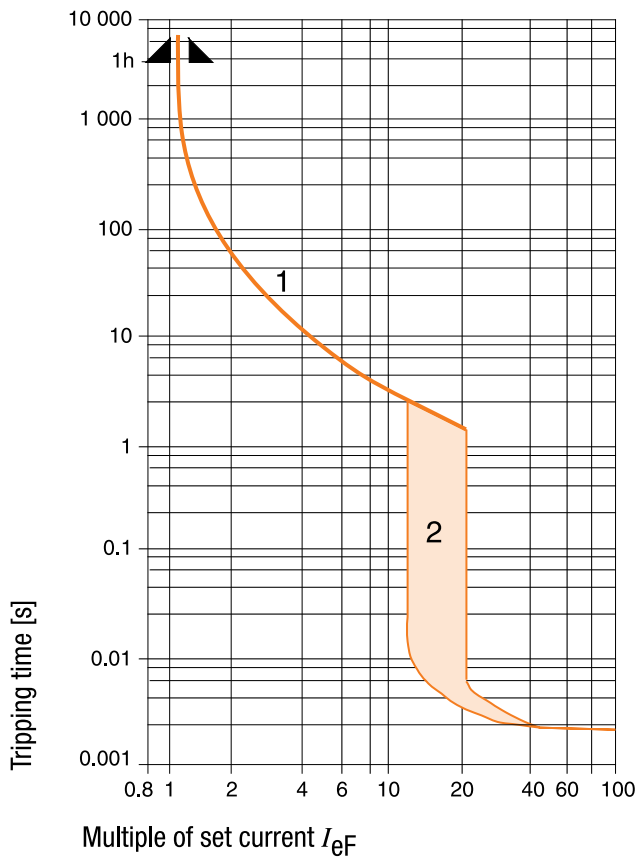

1. Thermal Release Trip Current

The adjustable current-dependent delayed bimetal release protects motors against overload. The curve shows the mean operating current at an ambient temperature of 20°C starting from the cold state. Careful testing and setting ensures effective motor protection even in the case of single-phasing. The overload characteristic is also valid for transformer protection.

2. Magnetic Release Trip Current

The instantaneous magnetic trip has a fixed operating current setting. This corresponds to 13...14 times the maximum value of setting range (high inrush protection -20 x I_o maximum). At a lower overload setting the magnetic trip is correspondingly higher.

Current Setting I_{ef}

The overload trip corresponds to a thermal overload relay in a motor starter conforming to IEC 947-4-1. If a different value is prescribed (e.g., reduced I_o for cooling medium having a temperature higher than 40°C or a place of installation higher than 2000m above sea level), the setting current is equal to the reduced rated current I_o of the motor.

F KT9 Motor Circuit Controllers

Cut-off Current ①

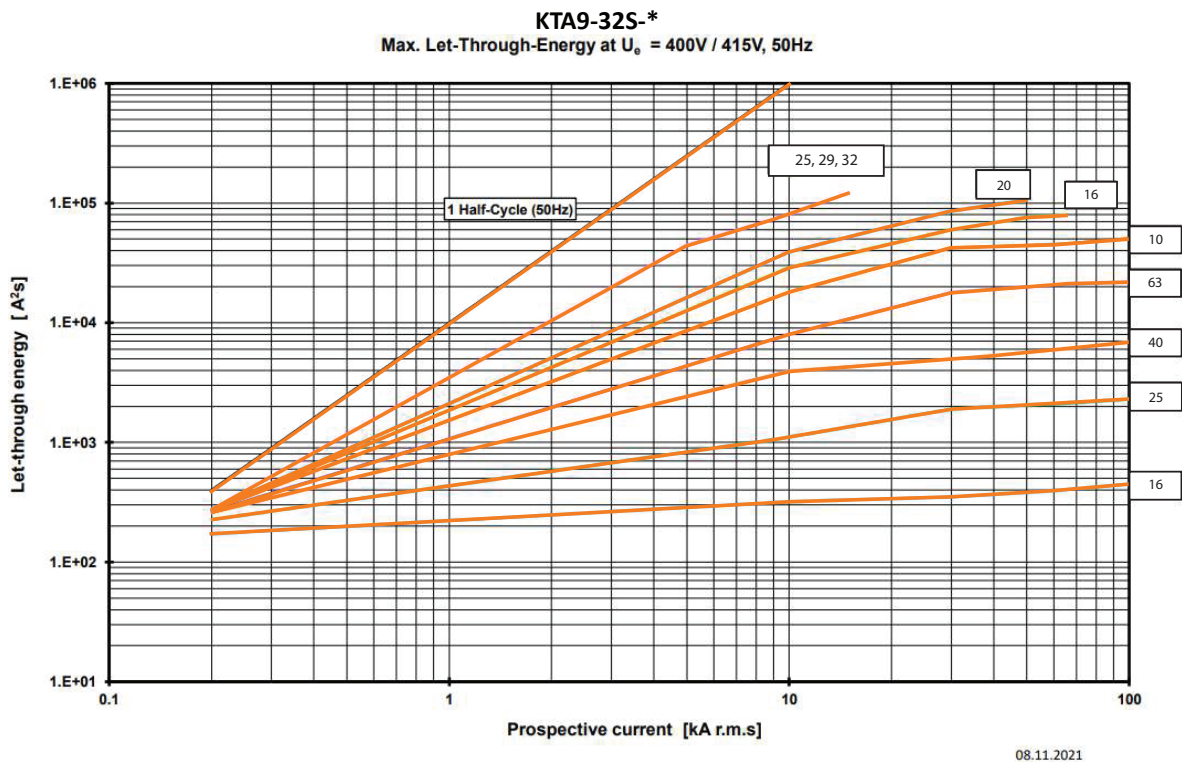
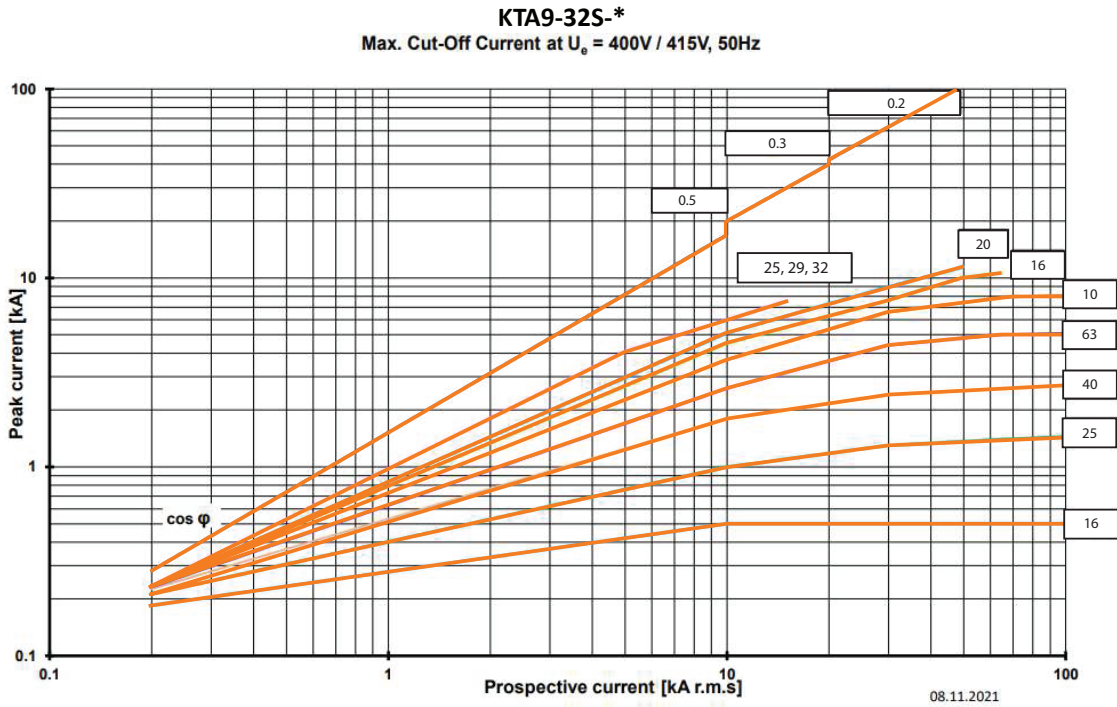

① A full size (8-1/2 x 11) set of "Maximum Cut-Off Current (Let-Thru Current)" and "Maximum Let-thru Energy (I²t)" curves for 400...415V, 500V and 690V can be downloaded from <http://www.sprechersschuh.com>.

Cut-off Current ①

F
 KT9 Motor Circuit Controllers

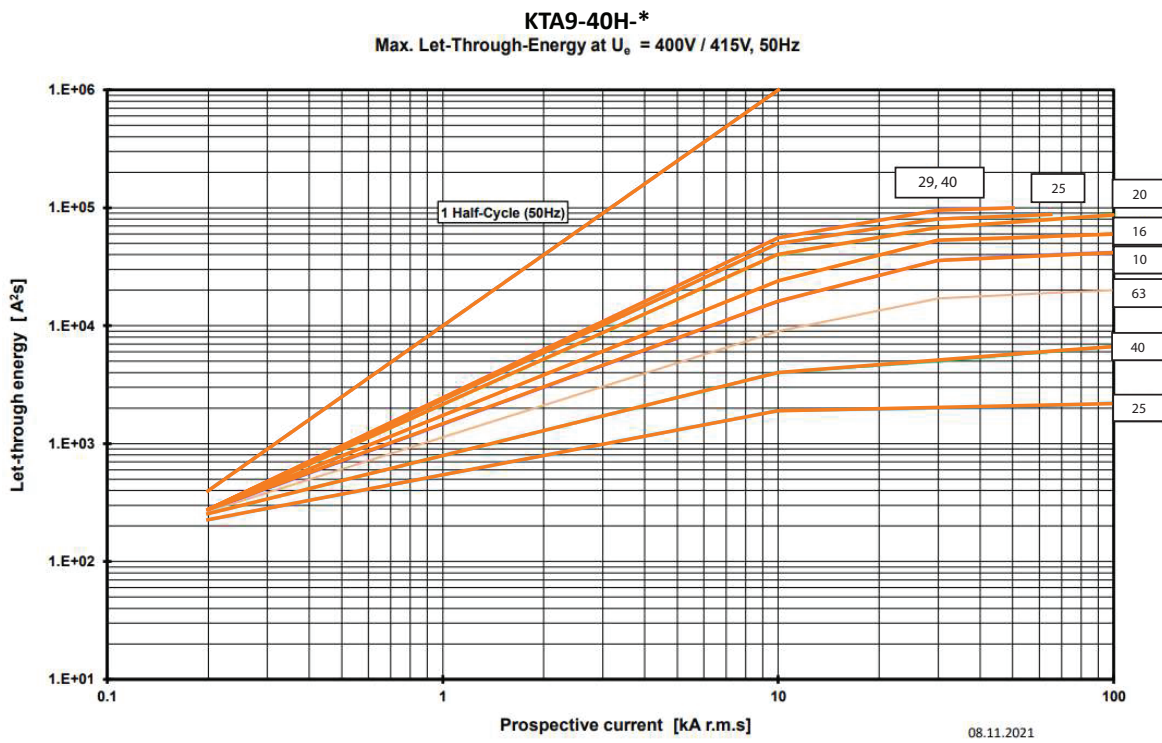
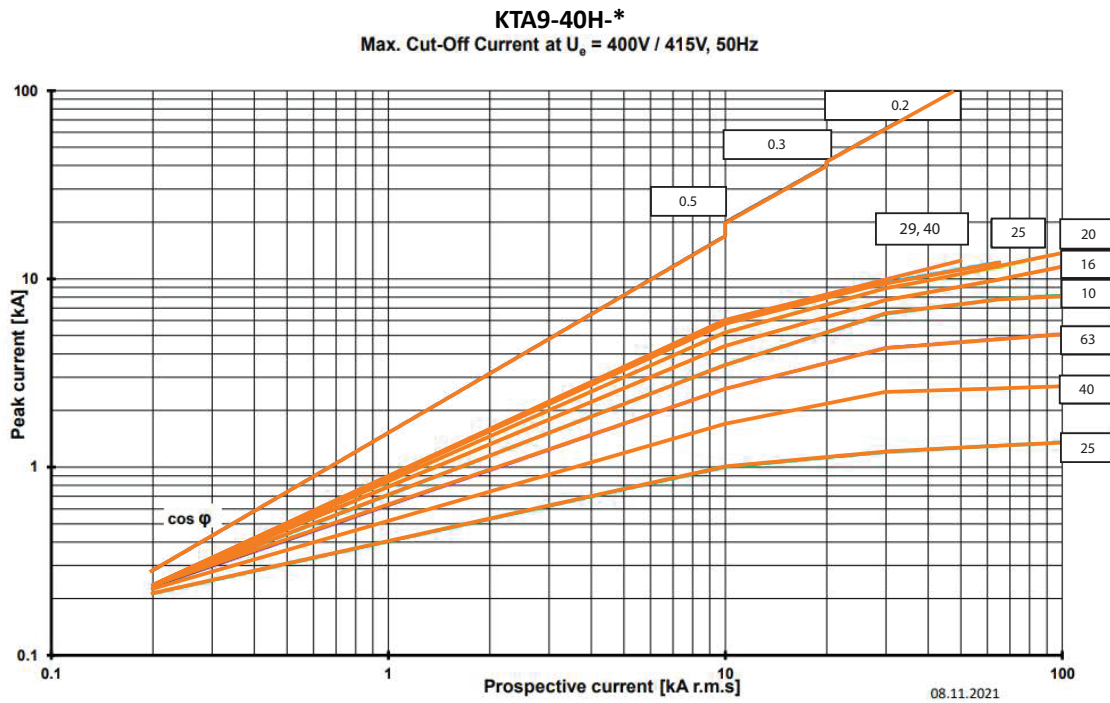

① A full size (8-1/2 x 11) set of "Maximum Cut-Off Current (Let-Thru Current)" and "Maximum Let-thru Energy (I²t)" curves for 400...415V, 500V and 690V can be downloaded from <http://www.sprecherschuh.com>.

Approximate Dimensions

KT_9 Devices and Accessories – Mounting Orientation

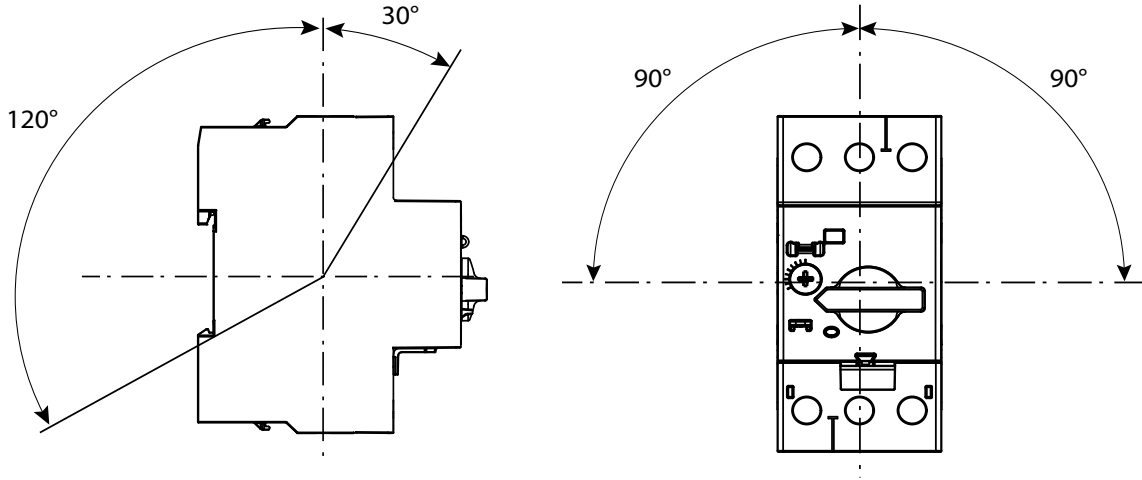

KT_9 Devices and Accessories – Spacing Requirements

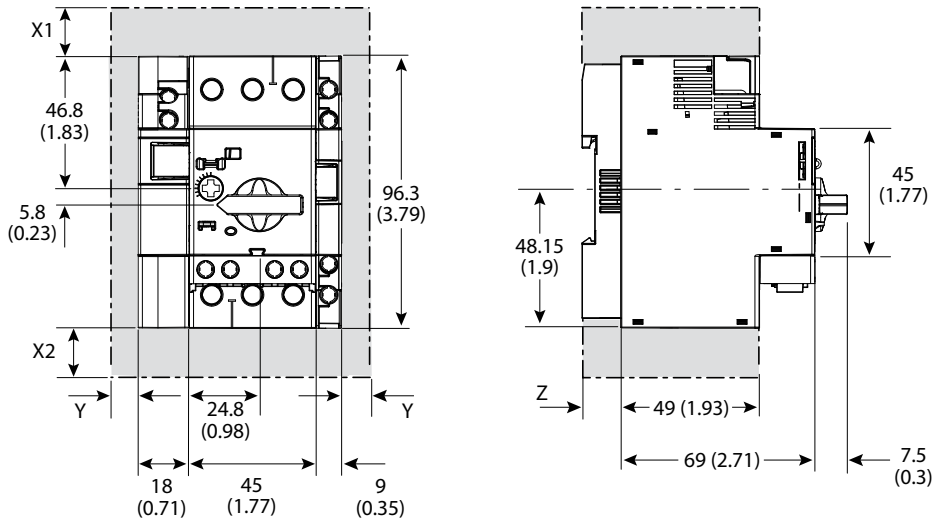

Frame Size	Voltage [V AC]	Minimum Distance to Grounded Parts or Walls [mm (in)]			Z
		X1	X2	Y	
KTA9-32S (C-Frame)	400	30 (1-3/16)	30 (1-3/16)	9 (23/64)	7.5 (19/64)
	500	30 (1-3/16)	30 (1-3/16)	9 (23/64)	
	690	50 (1-31/32)	50 (1-31/32)	30 (1-3/16)	
KT_9-40H (D-Frame)	400	30 (1-3/16)	30 (1-3/16)	9 (23/64)	13.5 (17/32)
	500	30 (1-3/16)	30 (1-3/16)	9 (23/64)	
	690	50 (1-31/32)	50 (1-31/32)	30 (1-3/16)	

❶ A full size (8-1/2 x 11) set of "Maximum Cut-Off Current (Let-Thru Current)" and "Maximum Let-thru Energy (I²t)" curves for 400...415V, 500V and 690V can be downloaded from <http://www.sprechersschuh.com>.

Motor Protection Circuit Breaker (C-Frame), Cat. No. KTA9-32S...

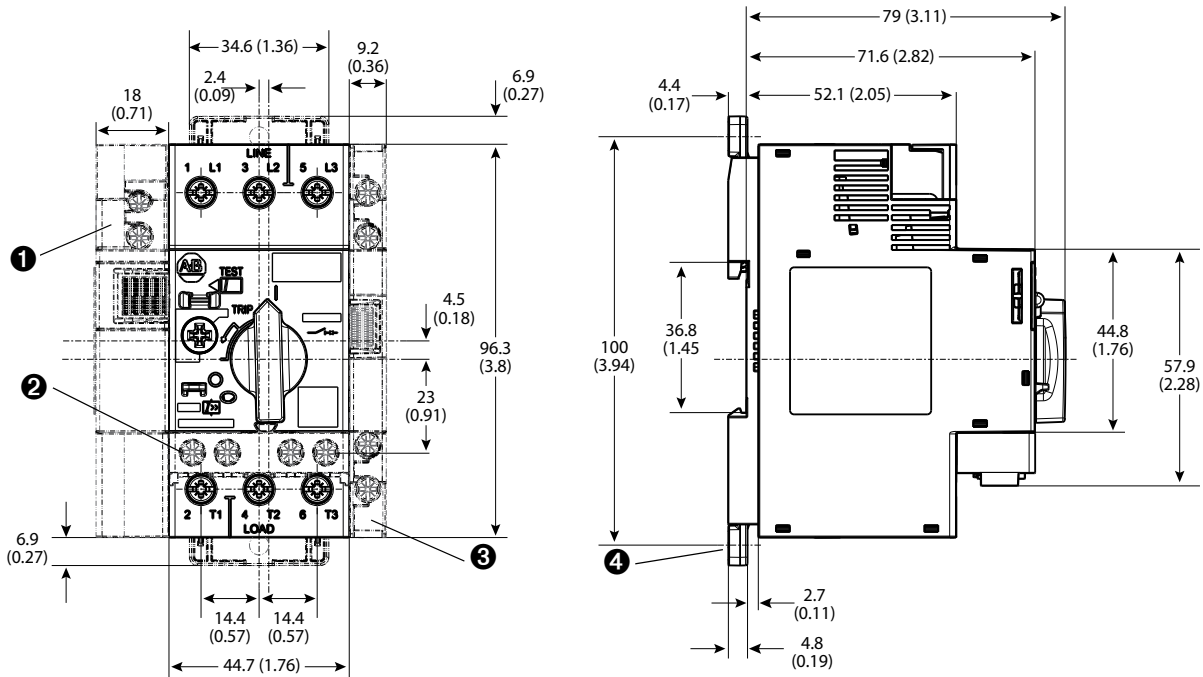

Motor Protection Circuit Breaker (D-Frame), Cat. No. KT_9-40H...

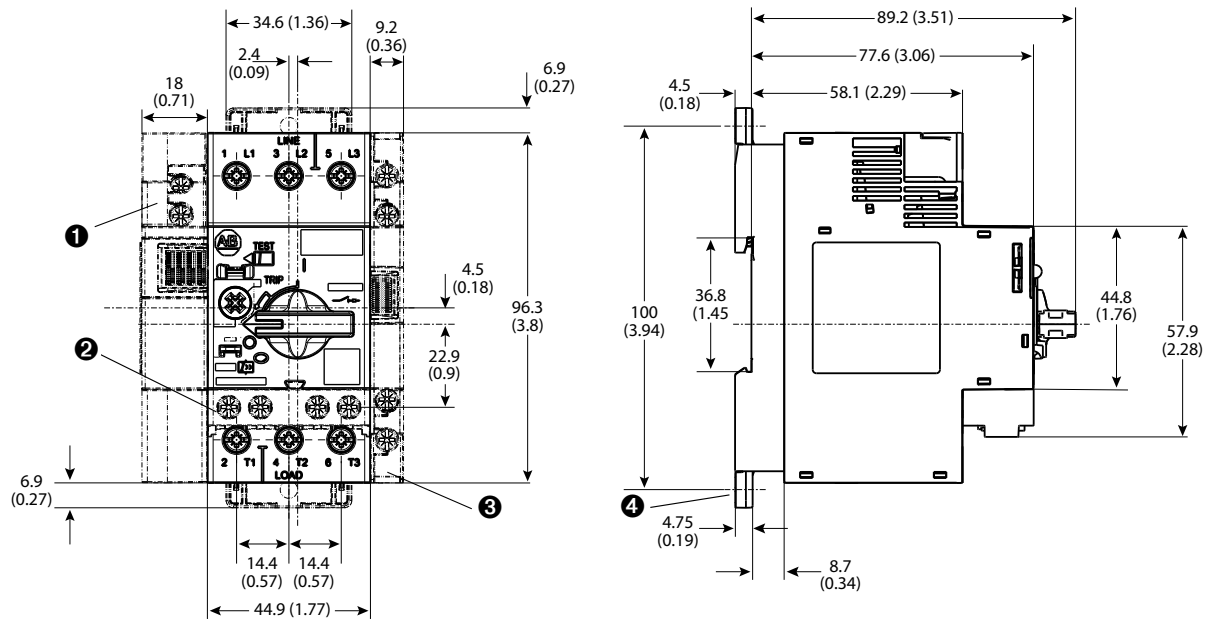

- ❶ Undervoltage/shunt trip
- ❷ Auxiliary contact (front mounted)
- ❸ Auxiliary contact (side mounted)
- ❹ Screw mounting adapter

F
KT9 Motor Circuit Controllers

Feeder Terminal for Compact Busbar, Cat. No. KT9-40-A3E

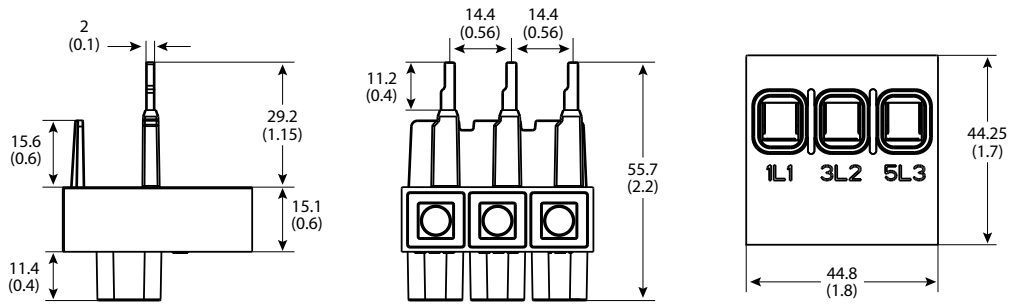

Terminal Cover, Cat. No. KT9-40-DBA

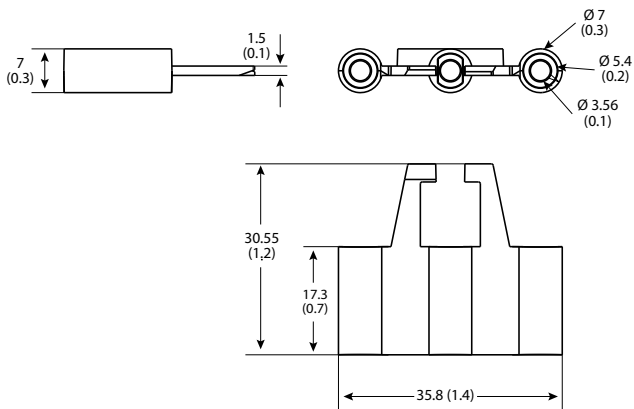

Supply Block, Cat. No. KT9-40-A2E

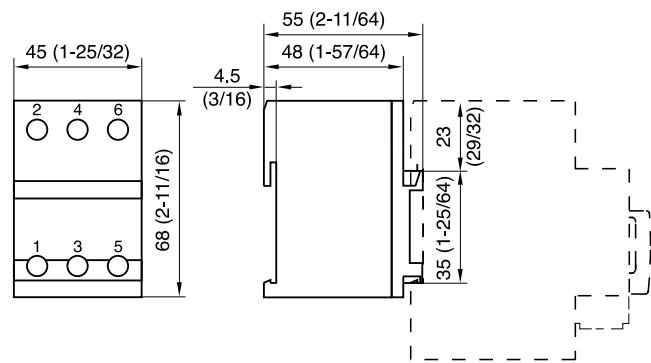

KT9-40-TE Type E adapter on Cat. No. KTA9-32S and KT_9-40H...

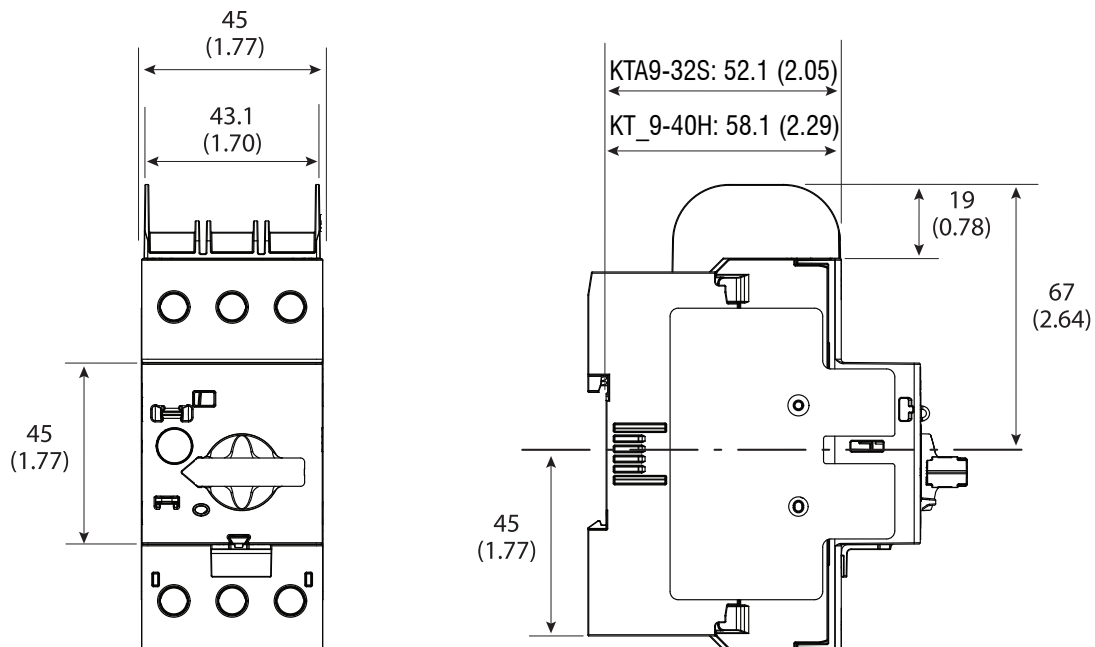

KT_7-45H Mounting Position / Safety Clearance

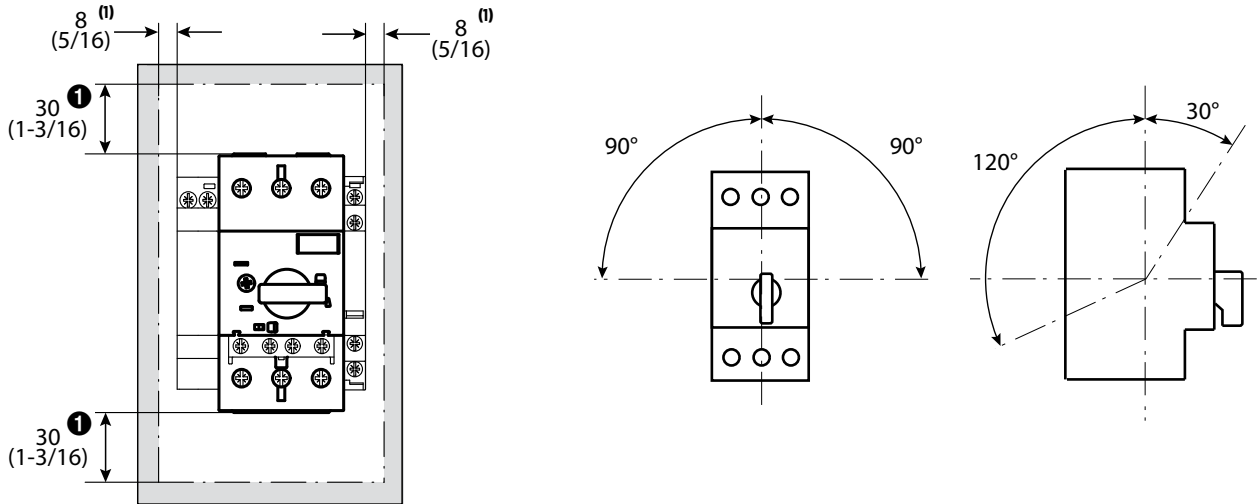

Motor Protection Circuit Breaker (F-Frame), Cat. No. Cat. No. KT_7-45H...

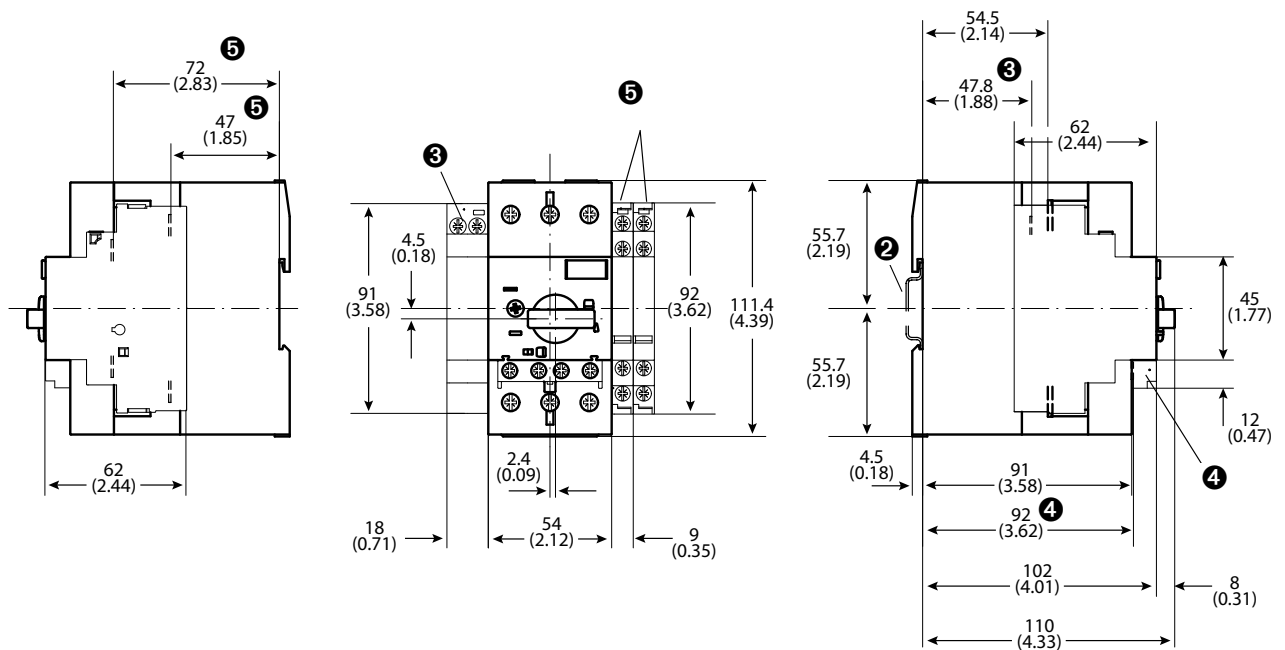

- ❶ Minimum distance to grounded parts or walls
- ❷ Mounting on 35 mm DIN Rail
- ❸ Undervoltage/shunt trip

- ❹ Auxiliary contact (front mounted)
- ❺ Auxiliary contact (side mounted)

KT7-45-TE Type E adapter on Cat. No. KT_7-45H...

Dimensions are in millimeters (inches). Dimensions not intended for manufacturing purposes.

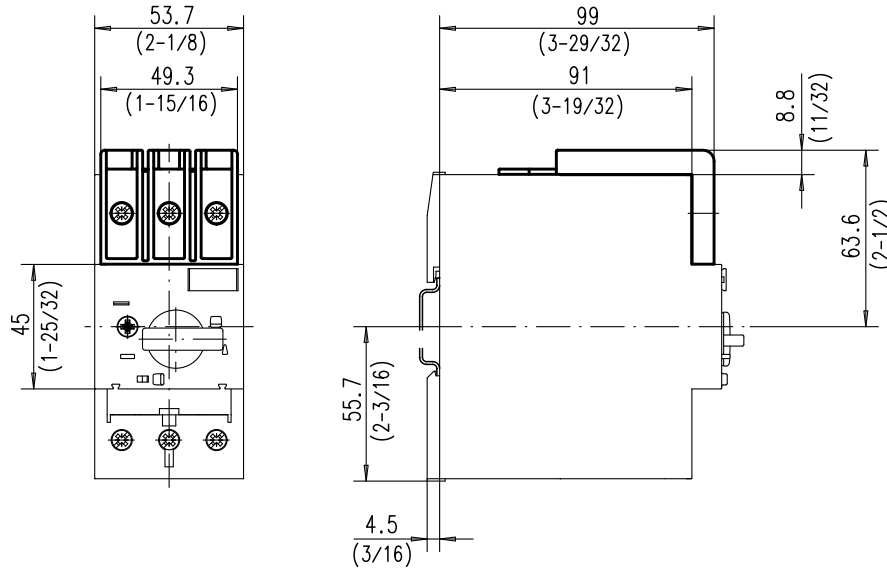

Screw Adapter, Cat. No. KT7-45-AS

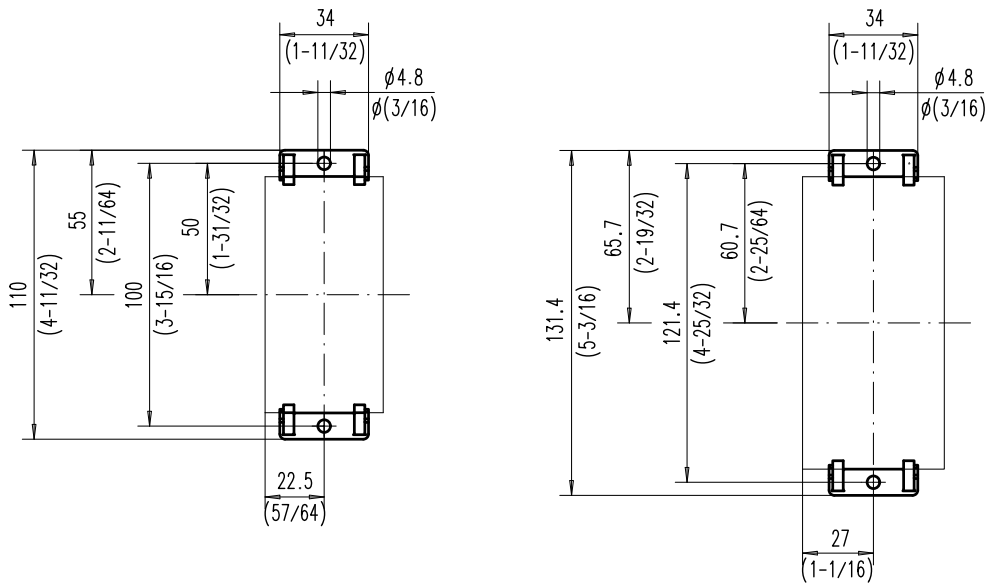

Series KTU9 UL489 Molded Case Circuit Breakers

Versatile, convenient
and space saving...
for a variety of
applications

Sprecher+Schuh's KTU9 series of UL Molded Case Circuit Breakers are UL489 and CE listed for global applications. The current limiting circuit breaker provides fixed short circuit and overcurrent protection and offers high interrupting ratings for 2- and 3-pole devices from 0.5 to 40A. These Circuit breakers are 100% rated up to 10A.

Accessories are intelligently designed to be field installed. The compact busbars and supply blocks reduce wiring errors and installation labor cost. Connection modules for the CA7 Contactors simplify wiring and can reduce the number of DIN rails required, compacting panel space even further.

Advantages...

- Small foot print saves panel space, just 45 x 96 x 89 mm, up to 50% smaller than traditional MCCBs.
- Interrupt rating of 65kA at 480Y/277V may allow higher overall panel short circuit rating
- Up to 6 times higher interrupting rating vs. traditional miniature circuit breakers.

Ideal Applications...

- Feeder Circuits
 - Small Cabinets
 - Distribution panels
 - Branch circuit protection
 - Transformers
 - Heaters
- Control Circuits
 - Control Transformers
 - Power supplies
- Heating, air conditioning and refrigeration (HACR)
- High-intensity discharge
- Switching duty (SWD) 15 and 20 A



Compare these advanced features

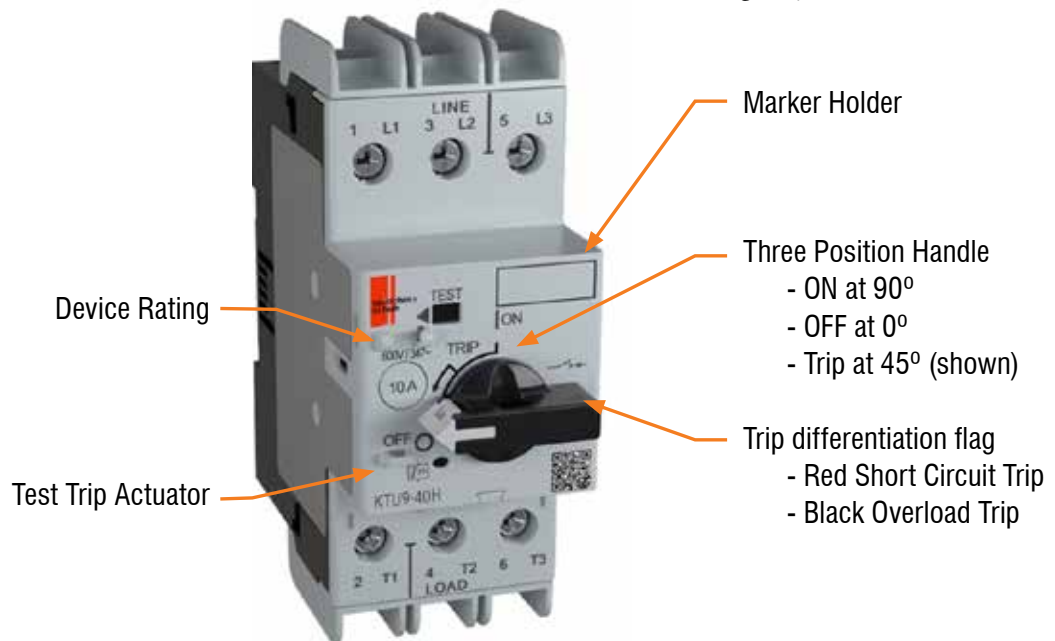

KTU9 Circuit Breaker, Fixed Thermal-Magnetic Ⓜ

Fixed Thermal Current Rating [A]	Magnetic Trip [A]	Interrupting Rating (60Hz) [KA]			Catalog Number
		240V	480Y/277V	600Y/347V	
KTU9-40H-2D — High Interrupting Capacity – 2-Pole					
0.5	15...20 x I _n	100	100	50	KTU9-40H-2D-0.5 Ⓜ
1.0	15...20 x I _n	100	100	50	KTU9-40H-2D-1 Ⓜ
2.0	15...20 x I _n	100	100	50	KTU9-40H-2D-2 Ⓜ
3.0	15...20 x I _n	100	100	50	KTU9-40H-2D-3 Ⓜ
4.0	15...20 x I _n	100	100	50	KTU9-40H-2D-4 Ⓜ
5.0	15...20 x I _n	100	100	50	KTU9-40H-2D-5 Ⓜ
6.0	15...20 x I _n	100	100	50	KTU9-40H-2D-6 Ⓜ
8.0	15...20 x I _n	100	100	50	KTU9-40H-2D-8 Ⓜ
10.0	15...20 x I _n	100	100	50	KTU9-40H-2D-10 Ⓜ
12.0	15...20 x I _n	65	65	25	KTU9-40H-2D-12
15.0	15...20 x I _n	65	65	25	KTU9-40H-2D-15
20.0	15...20 x I _n	65	65	~	KTU9-40H-2D-20
25.0	15...20 x I _n	65	65	~	KTU9-40H-2D-25
30.0	15...20 x I _n	65	65	~	KTU9-40H-2D-30
35.0	14 x I _n	65	65	~	KTU9-40H-2D-35
40.0	12 x I _n	65	65	~	KTU9-40H-2D-40
KTU9-40H-3D — High Interrupting Capacity – 3-Pole					
0.5	15...20 x I _n	100	100	50	KTU9-40H-3D-0.5 Ⓜ
1.0	15...20 x I _n	100	100	50	KTU9-40H-3D-1 Ⓜ
2.0	15...20 x I _n	100	100	50	KTU9-40H-3D-2 Ⓜ
3.0	15...20 x I _n	100	100	50	KTU9-40H-3D-3 Ⓜ
4.0	15...20 x I _n	100	100	50	KTU9-40H-3D-4 Ⓜ
5.0	15...20 x I _n	100	100	50	KTU9-40H-3D-5 Ⓜ
6.0	15...20 x I _n	100	100	50	KTU9-40H-3D-6 Ⓜ
8.0	15...20 x I _n	100	100	50	KTU9-40H-3D-8 Ⓜ
10.0	15...20 x I _n	100	100	50	KTU9-40H-3D-10 Ⓜ
12.0	15...20 x I _n	65	65	25	KTU9-40H-3D-12
15.0	15...20 x I _n	65	65	25	KTU9-40H-3D-15
20.0	15...20 x I _n	65	65	~	KTU9-40H-3D-20
25.0	15...20 x I _n	65	65	~	KTU9-40H-3D-25
30.0	15...20 x I _n	65	65	~	KTU9-40H-3D-30
35.0	14 x I _n	65	65	~	KTU9-40H-3D-35
40.0	12 x I _n	65	65	~	KTU9-40H-3D-40

Description

The KTU9 is a fixed trip, thermal-magnetic UL489 Molded Case Circuit Breaker.



KTU9-40H-3D



KTU9-40H-2D

F
KTU9 Molded Case Circuit Breakers

Ⓜ Suitable for continuous operation at 100% of rating only if used in minimum enclosure space of 250 x 175 x 150 mm (10 x 7 x 6 in).
 Ⓜ KTU9 has independent thermal elements suitable for power distribution applications (not two slide bar differential tripping).

Accessories available for KTU9

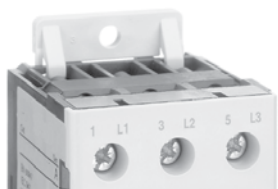
	<p>KT9-P.. Front/Side Mount Auxiliaries and Trip Contacts</p> <p>1-pole or 2-pole Side-mount not suitable for UL489 applications</p> <p>See pages F1.12-1.13</p>		<p>KT9-KN, KT9-KRY or KT9-DS</p> <p>See page F1.16</p>
	<p>KT9-UA Undervoltage Trips ② (UL 489 application up to 30 A) See page F1.14</p>		<p>Handle Assemblies KT9-SY or KT9-SB KT9-HTN or KT9-HTRY ②</p> <p>See page F1.15</p>
	<p>KT9-HT/HTL, KT9-S_/N_ & KT9-SHS Extension Shafts & Support</p> <p>See page F1.15</p>		<p>KT9-N45 Screw Adaptor</p> <p>See page F1.16</p>

F

KTU9 Molded Case Circuit Breakers



Extension Shaft Support Assembly

The KT9-SHS is recommended for handle shafts KT9-HT_ or KT9-S_/N_ in lengths greater than 200mm (7.8 inches).
See page F41



Remote Operation Application

The KTU9 3-Pole unit can be combined with CA7 using Connector Modules to achieve remote operation.

- For CA7-9...23 use KTU9-40H-PEC23

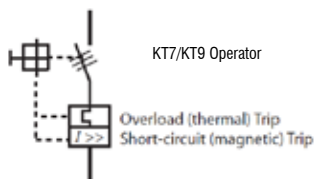

- ① Series B or later.
- ② Series E or later.
- ③ Undervoltage Trip Connection Diagram



Connecting Modules (for connecting KTU9 to CA7 AC coil, or CA7 Electronic DC coil contactors)

Module	Description	For Connecting...	To Contactor...	Catalog Number
	Connecting Modules <ul style="list-style-type: none"> • 25 Amp maximum • Provides electrical and mechanical interconnection of KTU9 3-Pole and CA7 (with AC coils) or CA7_E (with 12V or 24V Electronic DC coils) • KTU9 and Contactor mount on one DIN rail (see previous page for visual) 	KTU9-40H	CA7-9..23	KTU9-D-PEC23

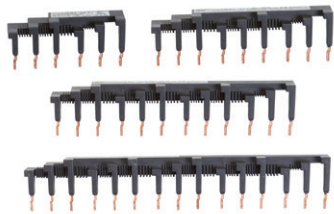
Compact Busbar System for KTU9

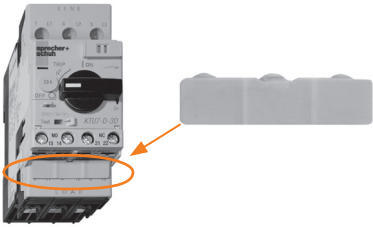
Accessory	Description	For Use With	Catalog Number
	Compact Busbar — 45 mm Spacing (Rated 64 A) <ul style="list-style-type: none"> • For use with front-mounted auxiliary contact Connects 2-KTU9s Connects 3-KTU9s Connects 4-KTU9s Connects 5-KTU9s (shown) 	KTU9-40H-3D	KTU9-D-DB-45-2 KTU9-D-DB-45-3 KTU9-D-DB-45-4 KTU9-D-DB-45-5
	Supply Block and Terminal <ul style="list-style-type: none"> • For power connection to Compact Busbar — 600V, KTU9-D...64A maximum • Top feed — overlaps commoning link • Meets requirements for terminal spacing from source • Compliant with UL489 Terminal Clearance standards 	KTU9-40H-3D	KTU9-D-A3E
	Load Terminal Cover <ul style="list-style-type: none"> • For UL 489 compliance of front mounted auxiliary contacts when installed on KTU9 • The cover packaged in quantities of 10 (must order 10 for one package of 10) 	KTU9	KTU9-D-PF

F
KTU9 Molded Case Circuit Breakers

IEC Performance Data

(CSA C22.2, UL 489, IEC / EN 60947-1, -2 in connection with a short-circuit protection device)

		KTU9-40H- 2 pole & 3 pole															
		0.5A	1A	2A	3A	4A	5A	6A	8A	10A	12A	15A	20A	25A	30A	35A	40A
Rated Operational Current I_n	[A]	0.5	1	2	3	4	5	6	8	10	12	15	20	25	30	35	40
Fixed Thermal Trip $I_t = I_n$	[A]	0.5	1	2	3	4	5	6	8	10	12	15	20	25	30	35	40
Fixed Magnetic Trip $I_m =$	[A]	15...20 x I_n															
Ultimate Short Circuit Breaking Capacity (50 Hz) I_{cu}																	
	230/240V [kA]	100	100	100	100	100	100	100	100	100	100	100	100	100	100	100	100
	400/415V [kA]	100	100	100	100	100	100	100	100	100	65	65	65	65	65	65	65
	500/525V [kA]	65	65	65	65	65	65	65	65	65	65	65	65	65	65	65	65
	690V [kA]	50	50	18	18	18	18	18	10	10	10	10	10	10	10	10	10
Rated Service Short Circuit Breaking Capacity (50 Hz) I_{cs}																	
	230/240V [kA]	100	100	100	100	100	100	100	100	100	100	100	100	100	100	100	100
	400/415V [kA]	65	65	65	65	65	65	65	65	65	50	50	50	50	50	50	50
	500/525V [kA]	65	65	65	65	65	65	65	65	65	50	50	50	25	25	25	25
	690V [kA]	50	50	10	10	10	10	10	6	6	6	6	6	6	6	6	6





F KTU9 Molded Case Circuit Breakers

General Data

		KTU9-D	
Number of Poles			2 and 3
Rated Insulation	IEC, / EN	[V]	690
Voltage U_i	UL, CSA	[V]	690
HACR Ratings	Suitable for continuous operation at 100% of rating only if used in enclosure space for	480Y/277V 600Y/347V	0.5...15 A, cubicle space 250 x 175 x 150 mm (10 x 7 x 6 in) 0.5...15 A, cubicle space 300 x 175 x 150mm (11.8 x 7 x 6in)
Rated Impulse Withstand Voltage U_{imp}	Pollution degree Main circuits U_{imp} /Overvoltage Category Auxiliary circuits U_{imp} /Overvoltage Category Safe separation between main and auxiliary circuits		3 6 kV/III 6 kV/III up to 400V
Rated Frequency		[Hz]	50/60
Utilization Category	IEC 60947-2 (Circuit breaker)		A
Life Span	Mechanical Electrical (t_e max.) Switching Frequency	[operations] [operations] [operations/hour]	100,000 10,000 max. 25
Ambient Temperature	Storage Operation	[°C (°F)] [°C (°F)]	-40...+80 -25...+60 (70 with 15% In current reduction) (-13...+140 °F [+158 with 15% In current reduction])
Climate Resistance	Moisture / Heat Resistance Dry Heat Moisture Heat	(600068-2-30) (60086-2-2) (60068-2-3)	23 °C (73 °F)/83% relative humidity and 40 °C (104 °F)/92% relative humidity, 56 cycles 100 °C (212 °F), relative humidity < 50%, 7 days 40 °C (104 °F), relative humidity 93%, 56 days
Site Altitude		[m]	up to 2000 N.N. (6561 ft)
Protection Class			IP2X when wired
Resistance to Shock, Transport		(60068-2-27)	30G, 11 ms, all axes
Resistance to Vibration, Operation		(60068-2-6)	18 G
Overload Protection Characteristics			Yes per IEC/EN 60947-2, UL489, CSA 22.2
Ambient Temperature Compensation		[°C (°F)]	-25...+60 (-13...+140)
Phase-loss Protection			No
Short-circuit protection (Magnetic)			fixed setting 15...20 x In, (35 A - 14 x In and 40 A - 12 x In)
Backfeeding			Suitable for backfeeding up to 480Y/277V
Total Power loss P_v	at In max	[W]	7.5
Main Disconnect Switch Application			Yes, with accessories
HID (High Intensity Discharge) Listed			0.5...40 A
Switching Duty			15 A, 20 A
Heating, air conditioning and refrigeration (HACR)			0.5...40 A
Application Conditions	For utilization outside North America, assemblies (of products) shall comply to the IEC 61439-1 requirements KTU9 are intended for use in closed areas without hazardous operating conditions such as dust or explosive or corrosive gases. Enclosures of appropriate manner need to be in place to protect devices in such environments.		
Standards Compliance			UL489; CSA C22.2 No. 5(1); IEC / EN 60947-1, -2
Certifications			CE; cULus Listed Circuit Breaker (pending)

F

KTU9 Molded Case Circuit Breakers

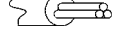
Connection		No. of conductors	KTU9 ≤ 15A	KTU9 > 15A
Power Terminals				
	Terminal Type		Screw Clamp up to 16 A, M4 Pozidriv No.2/Blade No.3	Screw Clamp greater than 16 A, M4 Pozidriv No.2/Blade No.3
	Screwdriver			
Solid or stranded		1 conductor	1...6 mm ²	1.5...10 mm ²
		2 conductor	1...2.5 mm ² 2.5...6 mm ²	1.5...4 mm ² 4...10 mm ²
Flexible with ferrule (end sleeve)		1 conductor	1...6 mm ²	1.5...10 mm ²
		2 conductor	1...2.5 mm ² 2.5...4 mm ²	1.5...4 mm ² 4...10 mm ²
Finely stranded		1 conductor	1.5...6 mm ²	2.5...10 mm ²
		2 conductor	1.5...4 mm ² 2.5...6 mm ²	2.5...6 mm ² 4...10 mm ²
Cross section per UL/CSA solid, stranded		1 conductor	No. 14...10 AWG	No. 14...8 AWG
		2 conductor	No. 14...10 AWG	No. 14...10 AWG No. 12...8 AWG
Stripping length			10 mm (0.39 in.)	10 mm (0.39 in.)
Tightening torque		[Nm]/[lb-in.]	2...2.5 / 18...22	2...2.5/18...22

Time-Current Characteristic

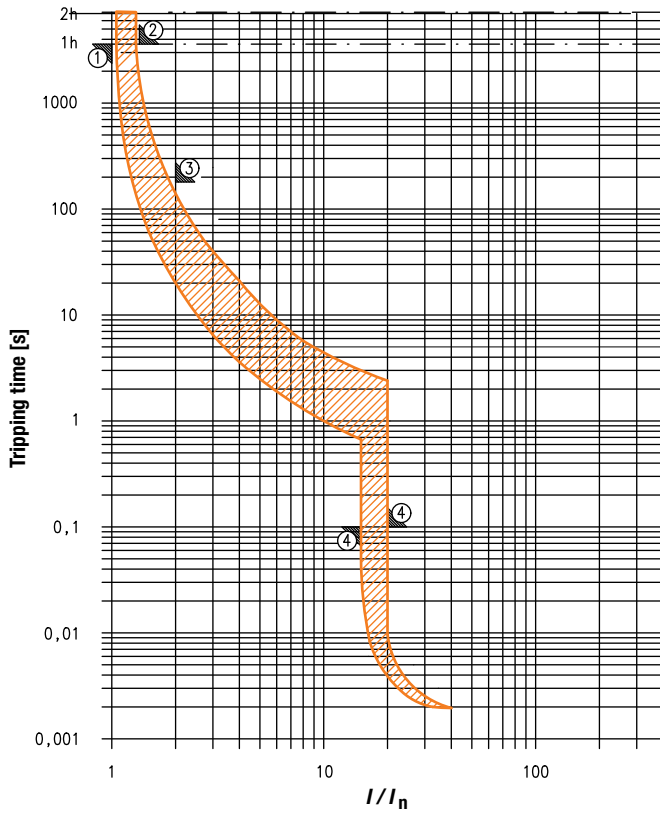

**Tripping characteristic
acc. to UL 489 and IEC 60947-2**

- ① conventional non-tripping current $I_{nt} = 1.0 I_n$
- ② conventional tripping current $I_t = 1.35 I_n ; t < 1h$
- ③ $2.0 I_n ; t = 180s$ max.

**Instantaneous tripping
acc. to UL 489 and IEC 60947-2**

- ④ Trip Curve : $15 \dots 20 I_n$

F

KTU9 Molded Case Circuit Breakers

Cut-off Current ①

KTU9-40H-D*-*
Max. Cut-Off Current at $U_0=480V/60Hz$

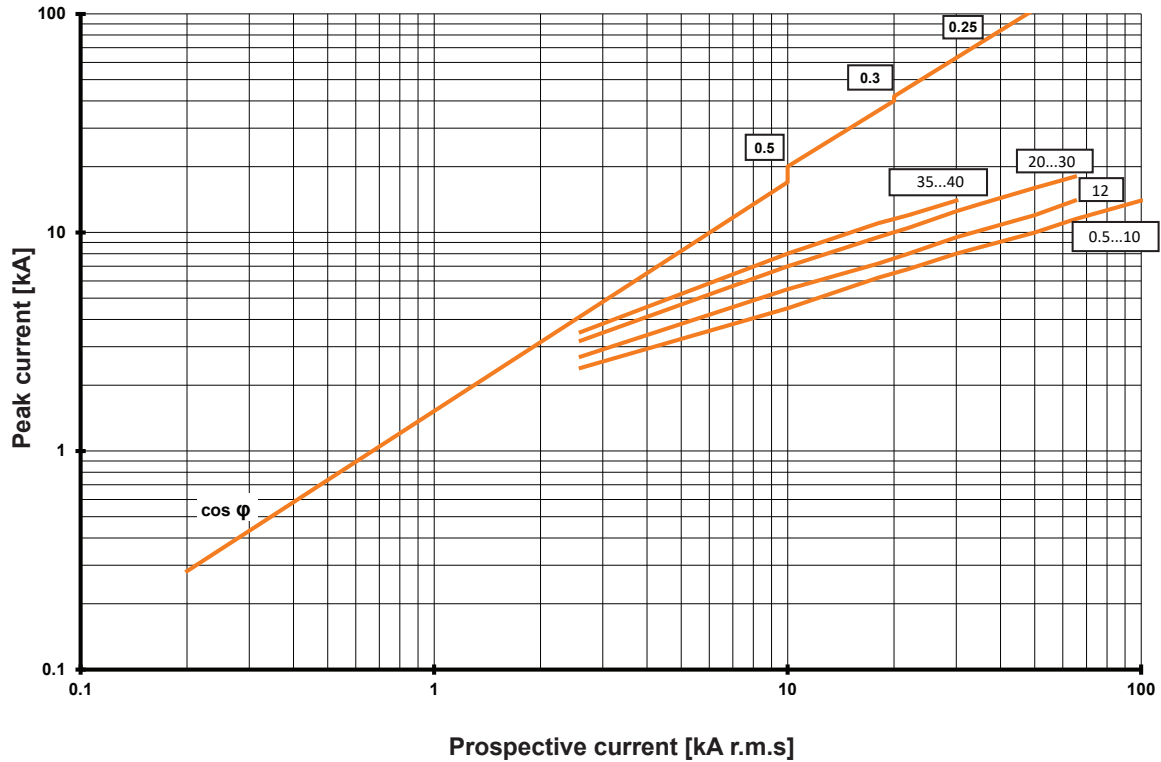

KTU9-40H-D*-*
Max. Let-Through-Energy at $U_0=480V/60Hz$

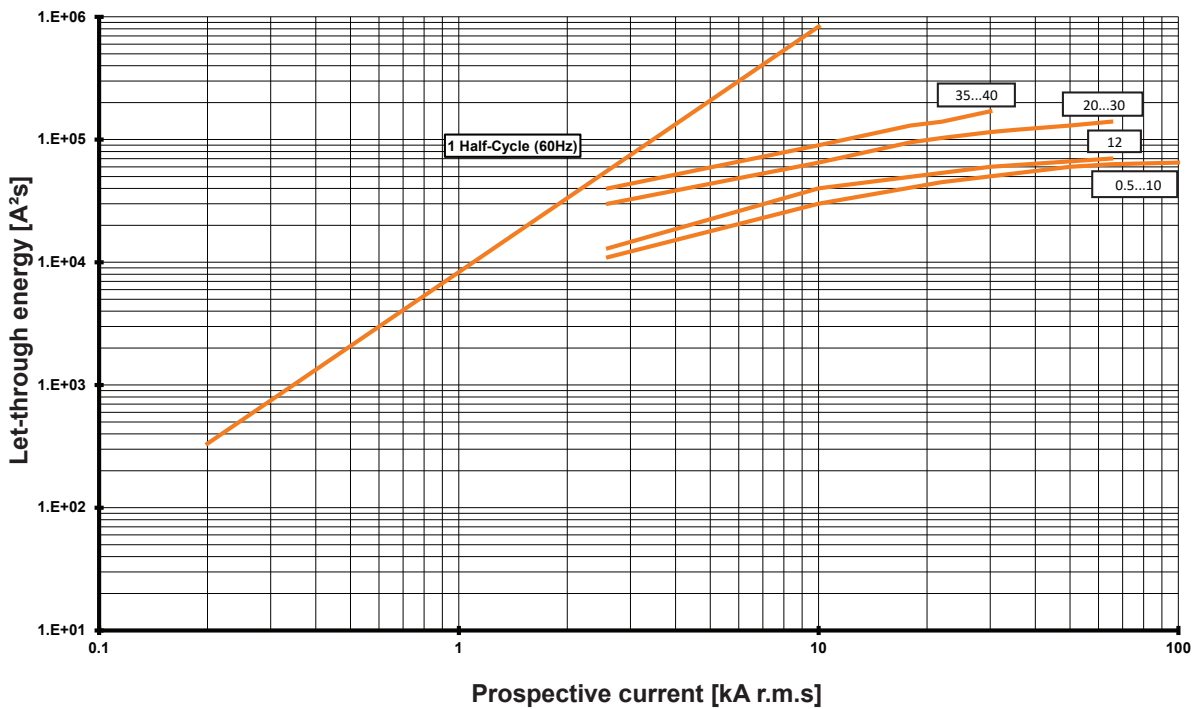

① A full size (8-1/2 x 11) set of "Maximum Cut-Off Current (Let-Thru Current)" and "Maximum Let-thru Energy (I²t)" curves for 400...415V, 500V and 690V can be downloaded from <http://www.sprecherschuh.com>.

F
KTU9 Molded Case Circuit Breakers

Cut-off Current ①

KTU9-40H-D*-*
Max. Cut-Off Current at $U_e=600V/60Hz$

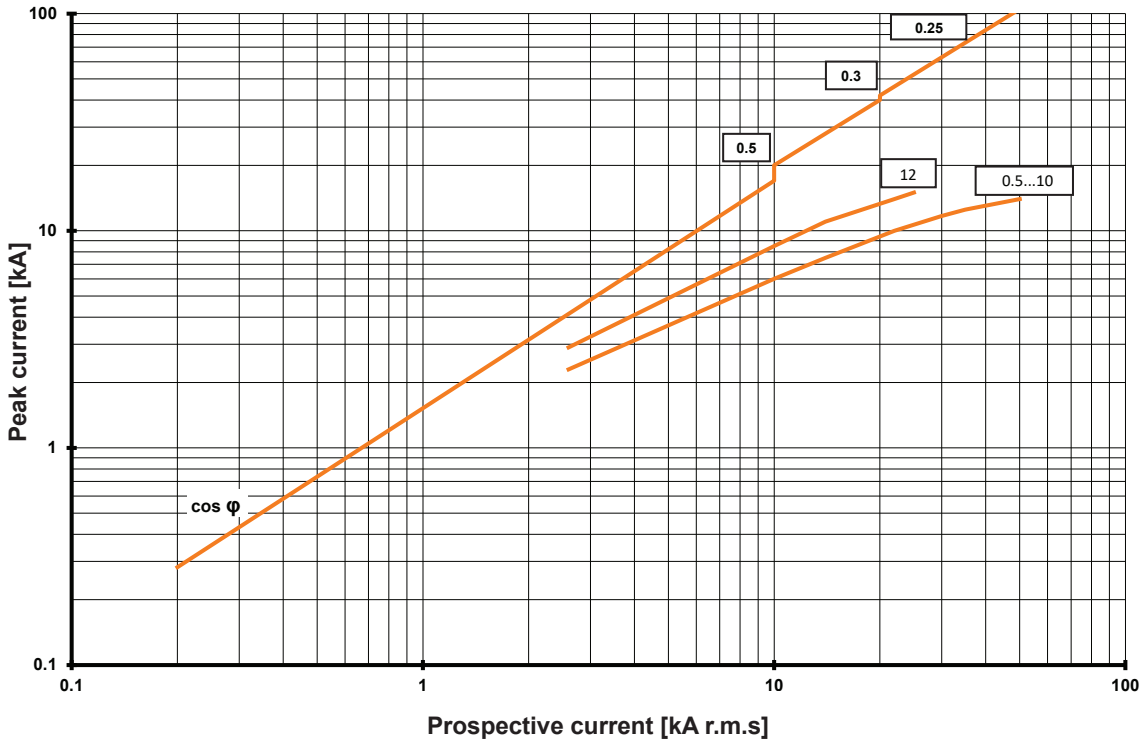

KTU9-40H-D*-*
Max. Let-Through-Energy at $U_e=600V/60Hz$

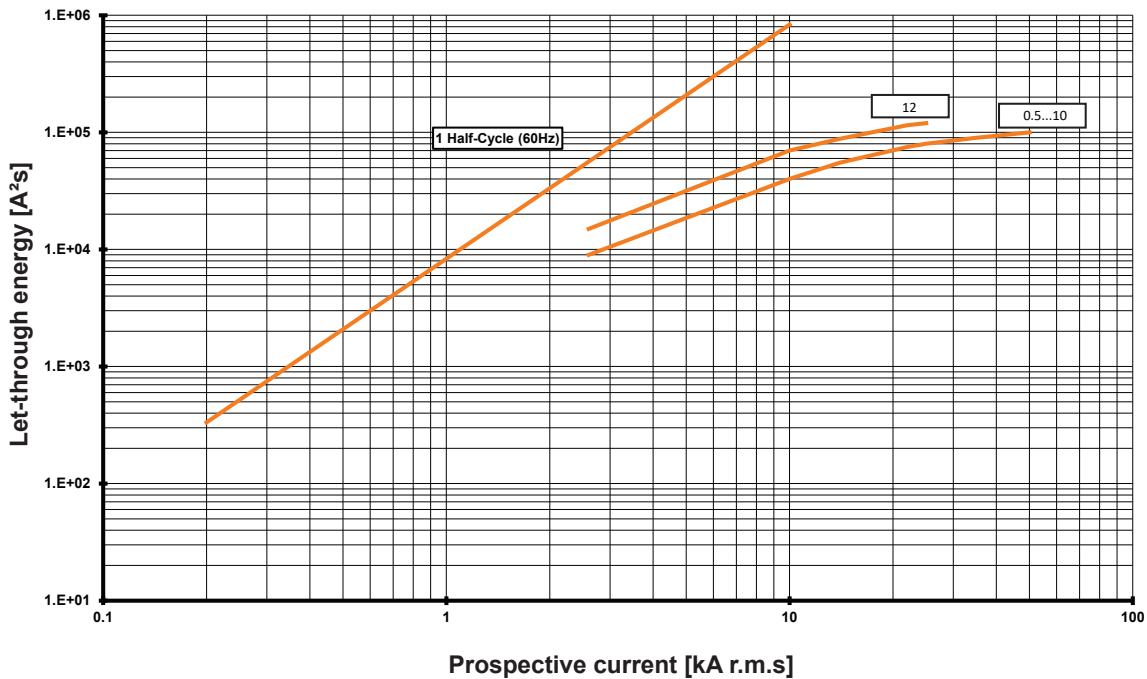

① A full size (8-1/2 x 11) set of "Maximum Cut-Off Current (Let-Thru Current)" and "Maximum Let-thru Energy (I²t)" curves for 400...415V, 500V and 690V can be downloaded from <http://www.sprechersschuh.com>.

KTU9-40H Dimensions

Dimensions are in millimeters (inches). Dimensions not intended for manufacturing purposes.

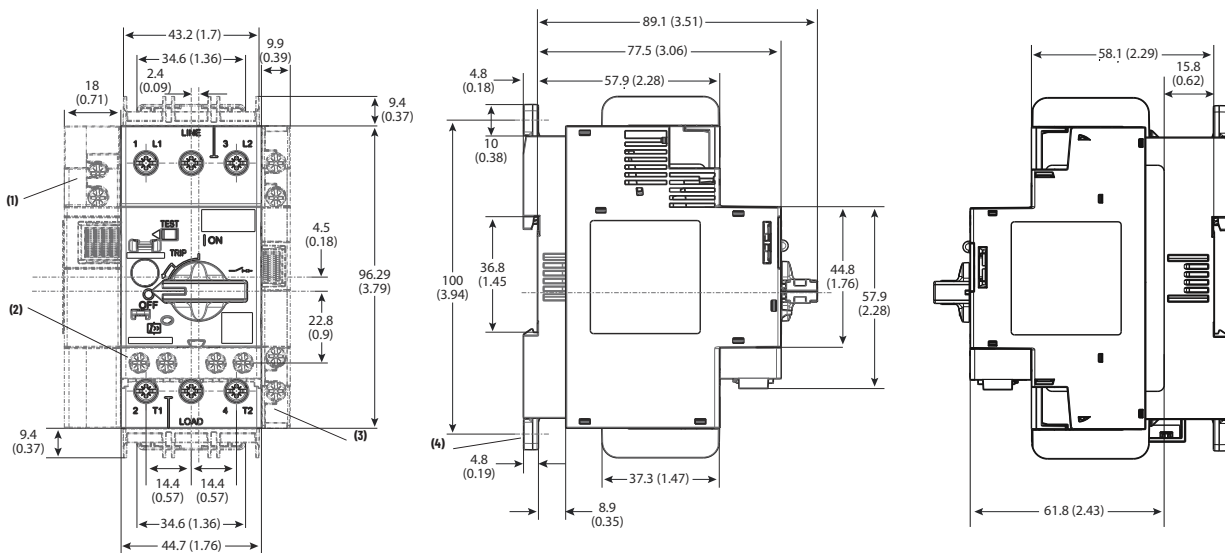

Note	Information
1	Undervoltage/shunt trip
2	Auxiliary contact (front mounted)
3	Auxiliary contact (side mounted)
4	Screw mounting adapter

KTU9 Wiring Diagram

**3-Phase
KTU9-40H-3D**

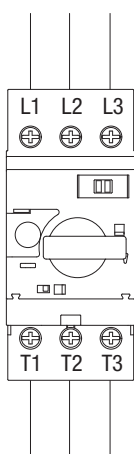

**2-Phase
KTU9-40H-2D**

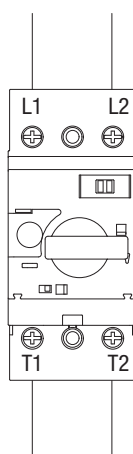

KTU9 with Screw Adaptor KT9-N45

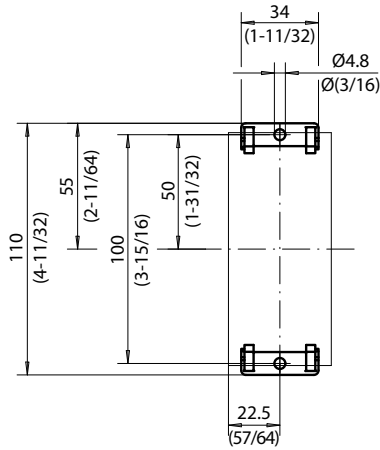

KTU9 Mounting Position

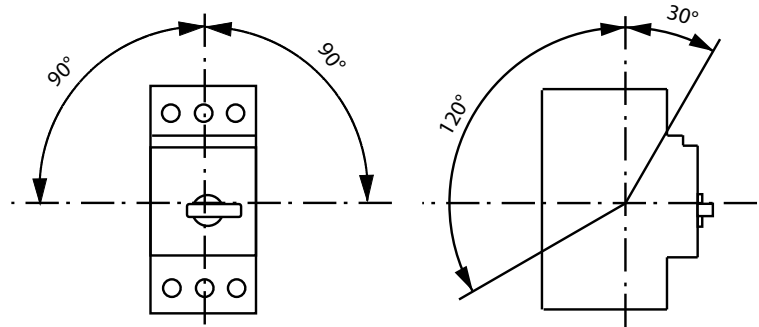

KTU9 Circuit Breaker Enclosure Requirements

Mounting Position and Spacing Requirements

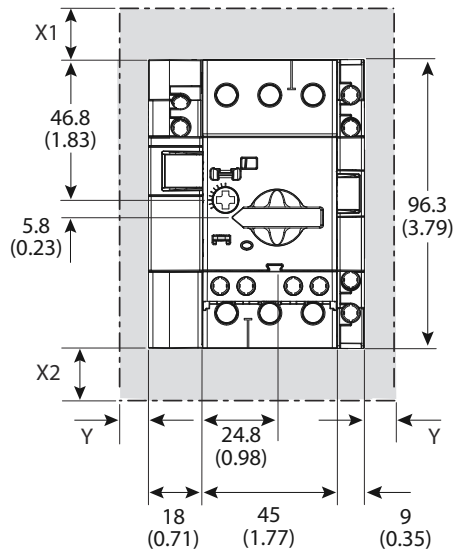

Voltage [V AC]	Minimum Distance to Grounded Parts or Walls [mm (in.)]		
	X1	X2	Y
400	30 (1-3/16)	30 (1-3/16)	9 (23/64)
500	30 (1-3/16)	30 (1-3/16)	9 (23/64)
690	50 (1-31/32)	50 (1-31/32)	30 (1-3/16)

F

KTU9 Molded Case Circuit Breakers

Ecombo Starters

Save space,
save money
in individual or
multi-motor
starter applications

Ecombo Circuit Controllers



See our online white paper

Methods of Applying

KT9

Motor Circuit Controllers

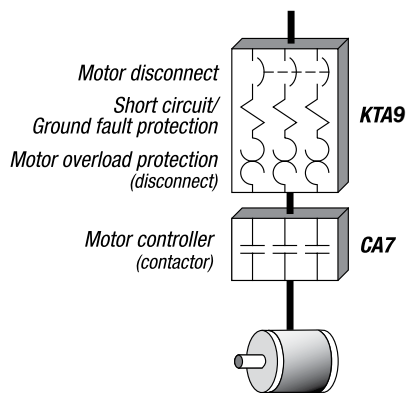

The Ecombo starter line combines a KTA9 self-protected Type E combination controller with a CA7 contactor to form a cost effective compact Type E/F alternative to traditional combination starters.

Sprecher + Schuh's Ecombo starters are the compact alternative to larger and higher priced combination starters. Both models consist of a KTA9 Motor Circuit Controller (cULus listed as a Type E, self-protected combination starter), assembled with a CA7 or CA8 contactor, which provides remote operation (Type E/F). Whether used as a standalone starter or in multi-motor starter applications, Ecombo starters save significant panel space and dollars over conventional combination starter alternatives.

Control and protection for most industrial applications

The Ecombo starter line covers motors to 40 amperes, while providing current limiting short circuit protection up to 65kA. Class 10 thermal overload protection is also assured with a very accurate current adjustment setting which is factory calibrated to the smallest and largest current the unit can handle. A "differential tripping" mechanism also provides accelerated tripping under single phase conditions (see illustration on page F3). Ecombo starters may be selected as Type 2 Coordinated per IEC 60947-4-1, or UL Construction Type E or F.

The Ecombo starter...

Ecombo starters (CLE) come standard with a KTA9 Motor Circuit Controller connected to Sprecher + Schuh's CA7 contactor (or CA8 mini contactor) through a specially designed connection module. The unit is DIN-rail mounted. Contactor coil connections are at the bottom of the starter to provide attractive and cost effective panel wiring. Ecombo starters may also be purchased with just three parts and assembled by the user to further increase economy. The CLE + O/L is a three component starter with a KTB9 controller, CA7 contactor, and a CEP7 solid state overload relay, pre-assembled on a bus bar module and ready to mount to a DIN rail or panel.



CLE Ecombo starter



CLE Three-Component starter

Reduce panel size, complexity and cost

Because KT9 Motor Circuit Controllers are UL listed as self-protected combination starters, NEC / CEC group motor rules are simplified substantially. In many cases, only a non-fused switch is required for panel disconnect. See our online white paper "Methods of Applying KT9 Motor Circuit Controllers", which explains applying KT9s in multi-motor starter applications.

Series	
CL	Non-reversing S+S
CLU	Reversing S+S

Mounting Style	
E	ECO (no mounting rail)
S	Sliding Din

Contactor Size	
809	9A
812	12A
709	9A
712	12A
716	16A
723	23A
730	30A
737	37A

Contactor Coil	
CA8	
024Z	24V 50Hz / 60Hz
0120	110V 50Hz / 120V 60Hz
0240	240V 50Hz / 60Hz
0600	525V 50Hz/ 600V60Hz CA
024D	24V DC
24DD	24V DC With Diode
CA7	
024Z	24V 50Hz / 60Hz
0120	110V 50Hz / 120V 60Hz
220W	208-220V 50Hz / 208-240V 60Hz
220W	240V 50Hz / 60Hz
0480	440V 50Hz / 480V 60Hz
0600	550V50Hz / 600V 60Hz
024E	24V DC

Contactor Aux	
01	1 N.C.
10	1 N.O.
02	2 N.C.
11	1 N.O. + 1 N.C.
12	1 N.O. + 2 N.C.
21	2 N.O. + 1 N.C.
22	2 N.O. + 2 N.C.
30	3 N.O.
31	3 N.O. + 1 N.C.
32	3 N.O. + 2 N.C.
33	3 N.O. + 3 N.C.

Breaker Frame	
C	KT9 C Frame MCPB only (32S)
D	KT9 D Frame MCPB or MCP (40H)

Breaker Current	
A16	0.1 - 0.16A
A25	0.16A - 0.25A
A40	0.25 - 0.40A
A63	0.40 - 0.63A
B10	0.63 - 1A
B16	1 - 1.6A
B25	1.6 - 2.5A
B40	2.5 - 4A
B63	4 - 6.3A
C10	6.3 - 10A
C16	10 - 16A
C20	14.5 - 20A
C25	18 - 25A
C29	23 - 29A
C32	26.5 - 32A
C36	30 - 36A
C40	34 - 40A

CL E - 709 0120 10 - C B40 B
 CLU E - 723 024E 22 - C C20 B
 CL E - 712 024Z 10 - C C16 B - FDB

Options	
-KN	Black Lockable Knob
-KY	Red/Yellow Lockable Knob
-TE	Spacing Adapter for Type E
-W	Mounting Module
-JE	Interface Adapter

Breaker Aux Code	
X	w/o Aux. and Trip Contacts
A	1 NC
B	1 NO
C	1 NO + 1 NC
D	2 NO
E	2 NC
R	1 NC + 1 NO (SC+OL)
S	1 NO + 1 NO (SC+OL)
T	1 NO + 1 NC (SC+OL)
N	1 NO (SC+OL) + 1 NC (SC)

Overload Relay	
-	No Separate Overload Relay
FAB	0.1...0.5A Solid State
FBB	0.12...1.0A Solid State
FCB	1.0...5.0A Solid State
FDB	3.2...16A Solid State
FEB	5.4...27A Solid State
FED	5.4...27A Solid State
FFD	11...55A Solid State

This illustration is for reference only.
 Turn to the appropriate page to determine
 specific catalog number.

❶ (D & E) designations indicate DC coil.

Non-Reversing Ecombo Starters with AC Coil, Series CA8 Contactor

Thermal Trip [A]	Magnetic Trip [A]	Typical Three Phase [HP]				Catalog Number ②
		200V	230V	460V	575V	
KTA9-32S – Standard Interrupting Capacity (14 x In)						
0.10...0.16A	2.2	~	~	~	~	CLE-809*10-CA16X
0.16...0.25A	3.5	~	~	~	~	CLE-809*10-CA25X
0.25...0.40A	5.6	~	~	~	~	CLE-809*10-CA40X
0.40...0.63A	8.8	~	~	~	~	CLE-809*10-CA63X
0.63...1.0A	14	~	~	1/2	1/2	CLE-809*10-CB10X
1.0...1.6A	22	~	~	3/4	3/4	CLE-809*10-CB16X
1.6...2.5A	35	1/2	1/2	1	1-1/2	CLE-809*10-CB25X
2.5...4.0A	56	3/4	3/4	2	3	CLE-809*10-CB40X
4.0...6.3A	88	1	1-1/2	3	5 ⑥	CLE-809*10-CB63X
6.3...10A	140	2	2	5	5 ⑥	CLE-809*10-CC10X
6.3...10A	140	2	2	5	7-1/2 ⑥	CLE-812*10-CC10X
10...16A	224	3	3	7-1/2	10 ⑥	CLE-812*10-CC16X



Includes:

- KTA9-32S (Standard Interrupting Capacity) Motor Controller
- CA8 Contactor
- Connecting Module (Cat.# KT9-32S-PEK12)
- Terminal Adaptor for Type F Applications (Cat.# KT9-40-TE)
- Can mount on one DIN-rail

Reversing Ecombo Starters with AC Coil, Series CA8 Contactor

Thermal Trip [A]	Magnetic Trip [A]	Typical Three Phase [HP]				Catalog Number ②
		200V	230V	460V	575V	
KTA9-32S – Standard Interrupting Capacity (14 x In)						
0.10...0.16A	2.2	~	~	~	~	CLUE-809*10-CA16X
0.16...0.25A	3.5	~	~	~	~	CLUE-809*10-CA25X
0.25...0.40A	5.6	~	~	~	~	CLUE-809*10-CA40X
0.40...0.63A	8.8	~	~	~	~	CLUE-809*10-CA63X
0.63...1.0A	14	~	~	1/2	1/2	CLUE-809*10-CB10X
1.0...1.6A	22	~	~	3/4	3/4	CLUE-809*10-CB16X
1.6...2.5A	35	1/2	1/2	1	1-1/2	CLUE-809*10-CB25X
2.5...4.0A	56	3/4	3/4	2	3	CLUE-809*10-CB40X
4.0...6.3A	88	1	1-1/2	3	5 ⑥	CLUE-809*10-CB63X
6.3...10A	140	2	2	5	5 ⑥	CLUE-809*10-CC10X
6.3...10A	140	2	2	5	7-1/2 ⑥	CLUE-812*10-CC10X
10...16A	224	3	3	7-1/2	10 ⑥	CLUE-812*10-CC16X



Includes:

- KTA9-32S (Standard Interrupting Capacity) Motor Controller
- One Reversing CAU8 Contactor with Mechanical Interlock (CM8)
- Connecting Module (Cat.# KT9-32S-PEK12)
- Terminal Adaptor for Type F Applications (Cat.# KT9-40-TE)
- Reversing Power Wiring Kit (Cat.# CAUT8-PW)
- Can mount on one DIN-rail

AC Coil Code	Voltage Range	
	50 Hz	60 Hz
024Z	24V	24V
0120	110V	120V
0240	240V	240V
0380 ④	Use Coil Code 0400	
0400 ④	400V	400V
0480	440V	480V
0575 ⑤	Use Coil Code 0600	
0600 ⑤	525V	600V

Horsepower ratings shown in the tables are for reference only. The final selection of the controller depends on the actual motor full load current and service factor.

- For motor with service factor less than 1.15. Use motor nameplate full load current times 0.9 and choose the motor starter with the appropriate current range. Example: Motor F.L.C. = 4.2A; S.F. = 1.0. – 4.2A x 0.9 = 3.78A. Select Catalog Number KTA9-32S-4.0A.

① KAIC Assembly Rating Index. See pages F73-F76 for Application Rating Guide.

② Does not include auxiliary contacts. See Factory Options on page F69 for additional auxiliary contact configurations.

③ The coil codes shown are the most commonly stocked items. Contact your Sprecher + Schuh representative if special voltages are required.

④ The European Community has agreed that 400V is the nominal voltage in lieu of 380V. Use this code when 380V is required.

⑤ Use this code for 575V applications.

⑥ Catalog numbers with specific voltages (i.e. @ 575V) shaded in gray are suitable for use as a manual motor starter only because they are not Type E rated. See page F5 for ratings.

Non-Reversing Ecombo Starters with DC Coil, Series CA8 Contactor

Thermal Trip [A]	Magnetic Trip [A]	Typical Three Phase [HP]				Catalog Number ②
		200V	230V	460V	575V	
KTA9-32S – Standard Interrupting Capacity (14 x In)						
0.10...0.16A	2.2	~	~	~	~	CLE-809*D10-CA16X
0.16...0.25A	3.5	~	~	~	~	CLE-809*D10-CA25X
0.25...0.40A	5.6	~	~	~	~	CLE-809*D10-CA40X
0.40...0.63A	8.8	~	~	~	~	CLE-809*D10-CA63X
0.63...1.0A	14	~	~	1/2	1/2	CLE-809*D10-CB10X
1.0...1.6A	22	~	~	3/4	3/4	CLE-809*D10-CB16X
1.6...2.5A	35	1/2	1/2	1	1-1/2	CLE-809*D10-CB25X
2.5...4.0A	56	3/4	3/4	2	3	CLE-809*D10-CB40X
4.0...6.3A	88	1	1-1/2	3	5 ⑤	CLE-809*D10-CB63X
6.3...10A	140	2	2	5	5 ⑤	CLE-809*D10-CC10X
6.3...10A	140	2	2	5	7-1/2 ⑥	CLE-812*D10-CC10X
10...16A	224	3	3	7-1/2	10 ⑥	CLE-812*D10-CC16X

Reversing Ecombo Starters with DC Coil, Series CA8 Contactor

Thermal Trip [A]	Magnetic Trip [A]	Typical Three Phase [HP]				Catalog Number ②
		200V	230V	460V	575V	
KTA9-32S – Standard Interrupting Capacity (14 x In)						
0.10...0.16A	2.2	~	~	~	~	CLUE-809*D10-CA16X
0.16...0.25A	3.5	~	~	~	~	CLUE-809*D10-CA25X
0.25...0.40A	5.6	~	~	~	~	CLUE-809*D10-CA40X
0.40...0.63A	8.8	~	~	~	~	CLUE-809*D10-CA63X
0.63...1.0A	14	~	~	1/2	1/2	CLUE-809*D10-CB10X
1.0...1.6A	22	~	~	3/4	3/4	CLUE-809*D10-CB16X
1.6...2.5A	35	1/2	1/2	1	1-1/2	CLUE-809*D10-CB25X
2.5...4.0A	56	3/4	3/4	2	3	CLUE-809*D10-CB40X
4.0...6.3A	88	1	1-1/2	3	5 ⑤	CLUE-809*D10-CB63X
6.3...10A	140	2	2	5	5 ⑤	CLUE-809*D10-CC10X
6.3...10A	140	2	2	5	7-1/2 ⑥	CLUE-812*D10-CC10X
10...16A	224	3	3	7-1/2	10 ⑥	CLUE-812*D10-CC16X



- Includes:*
- KTA9-32S (Standard Interrupting Capacity) Motor Controller
 - CA8 Contactor
 - Connecting Module (Cat.# KT9-32S-PEK12)
 - Terminal Adaptor for Type F Applications (Cat.# KT9-40-TE)
 - Can mount on one DIN-rail

F
Ecombo Circuit Controllers



- Includes:*
- KTA9-32S (Standard Interrupting Capacity) Motor Controller
 - One Reversing CAU8 Contactor with Mechanical Interlock (CM8)
 - Connecting Module (Cat.# KT9-32S-PEK12)
 - Terminal Adaptor for Type F Applications (Cat.# KT9-40-TE)
 - Reversing Power Wiring Kit (Cat.# CAUT8-PW)
 - Can mount on one DIN-rail

DC Coil Code	Voltage
012	12V
024	24V ④
110	110V
125	125V
220	220V

Horsepower ratings shown in the tables are for reference only. The final selection of the controller depends on the actual motor full load current and service factor.

- For motor with service factor less than 1.15. Use motor nameplate full load current times 0.9 and choose the motor starter with the appropriate current range. Example: Motor F.L.C. = 4.2A; S.F. = 1.0. – 4.2A x 0.9 = 3.78A. Select Catalog Number KTA9-32S-4.0A.

- ① KAIC Assembly Rating Index. See pages F73-F76 for Application Rating Guide.
- ② Does not include auxiliary contacts. See Factory Options on page F1.48 for additional auxiliary contact configurations.
- ③ The coil codes shown are the most commonly stocked items. Contact your Sprecher + Schuh representative if special voltages are required.
- ④ Integrated surge suppressor for coil is available. See page F1.48 for options.
- ⑤ The European Community has agreed that 400V is the nominal voltage in lieu of 380V. Use this code when 380V is required.
- ⑥ Use this code for 575V applications.
- ⑦ Catalog numbers with specific voltages (i.e. @ 575V) shaded in gray are suitable for use as a manual motor starter only because they are not Type E rated. See page F5 for ratings.

Non-Reversing Ecombo Starters with AC Coil, Series CA7 Contactor ②

Thermal Trip [A]	Magnetic Trip [A]	Typical Three Phase [HP]				Catalog Number ①
		200V	230V	460V	575V	
KTA9-32S - Standard Interrupting Capacity (14 x In)						
0.10...0.16A	2.2	~	~	~	~	CLE-709*10-CA16B
0.16...0.25A	3.5	~	~	~	~	CLE-709*10-CA25B
0.25...0.40A	5.6	~	~	~	~	CLE-709*10-CA40B
0.40...0.63A	8.8	~	~	~	~	CLE-709*10-CA63B
0.63...1.0A	14	~	~	1/2	1/2	CLE-709*10-CB10B
1.0...1.6A	22	~	~	3/4	3/4	CLE-709*10-CB16B
1.6...2.5A	35	1/2	1/2	1	1-1/2	CLE-709*10-CB25B
2.5...4.0A	56	3/4	3/4	2	3	CLE-709*10-CB40B
4.0...6.3A	88	1	1-1/2	3	5 ④	CLE-709*10-CB63B
6.3...10A	140	2	2	5	7-1/2 ④	CLE-709*10-CC10B
6.3...10A	140	3	3	7-1/2	7-1/2 ④	CLE-712*10-CC10B
10...16A	224	3	5	10	10 ④	CLE-716*10-CC16B
KTA9-40H – High Interrupting Capacity (14 x In)						
0.40...0.63A	8.8	~	~	~	~	CLE-709*10-DA63B
0.63...1.0A	14	~	~	1/2	1/2	CLE-709*10-DB10B
1.0...1.6A	22	~	~	3/4	3/4	CLE-709*10-DB16B
1.6...2.5A	35	1/2	1/2	1	1-1/2	CLE-709*10-DB25B
2.5...4.0A	56	3/4	3/4	2	3	CLE-709*10-DB40B
4.0...6.3A	88	1	1-1/2	3	5	CLE-709*10-DB63B
6.3...10A	140	2	2	5	7-1/2	CLE-709*10-DC10B
6.3...10A	140	2	2	5	7-1/2	CLE-712*10-DC10B
10...16A	224	3	5	10	10	CLE-716*10-DC16B
14.5...20A	280	5	5	10	15 ④	CLE-723*10-DC20B
18...25A	350	5	7-1/2	15	20 ④	CLE-723*10-DC25B
23...29A	406	7-1/2	10	20	25 ④	CLE-730*10-DC29B
26.5...32A	448	7-1/2	10	20	30 ④	CLE-730*10-DC32B
30...36A	432	10	10	25	30 ④	CLE-737*10-DC36B
34...40A	480	10	10	25	30 ④	CLE-737*10-DC40B
KTA7-45H – High Interrupting Capacity (13 x In)						
6.3...10A	130	2	3	5	7-1/2	CLE-730*10-FC10B-W ②
10...16A	208	3	5	10	10	CLE-730*10-FC16B-W ②
14.5...20A	260	5	5	10	15	CLE-730*10-FC20B-W ②
18...25A	325	7-1/2	7-1/2	15	20	CLE-730*10-FC25B-W ②
23...32A	416	7-1/2	10	20	25	CLE-730*10-FC32B-W ②
32...45A	585	10	10	25	30	CLE-737*10-FC45B-W ②
32...45A	585	10	15	30	30	CLE-743*11-FC45C-W ② ③

For applications above 45 amps please consider open type combination starters on page C59.

Coil Codes (*) ①

AC Coil Code	Voltage Range	
	50 Hz	60 Hz
024Z	24V	24V
0120	110V	120V
220W	200-220V	208-240V
230Z	230V	230V
0277	240V	277V
0415	400-415V	~
0480 ⑤	440V	480V
0600 ⑤	550V	600V

Horsepower ratings shown in the tables are for reference only. The final selection of the controller depends on the actual motor full load current and service factor.

- For motor with service factor less than 1.15. Use motor nameplate full load current times 0.9 and choose the motor starter with the appropriate current range. Example: Motor F.L.C. = 4.2A; S.F. = 1.0. - 4.2A x 0.9 = 3.78A. Select Catalog Number KTA9-32S-4.0A.



Includes:

- KT9 Motor Controller with 1 NO Auxiliary Contact
- CA7 Contactor (AC)
- Connecting Module (Cat.# KT9-32S or 40H-PEC23)
- Terminal Adaptor for Type E/F Applications
- Can mount on one DIN-rail

Optional: ②

- Type W Mounting Module is optional on 32S & 40H. Type W Module is standard on C26 to C29 and 45H models. See modifications on page F69.

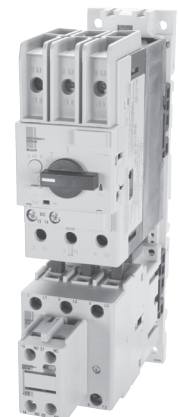

Ordering Instructions

Specify Catalog Number	
Replace (*) with Coil Code	See Coil Code table on this page for codes.

① Other voltages available, see Section A in this catalog.

② CLE-730...743 with KTA7-45H include Type W Mounting Modules for 35mm or 70mm DIN rail or Panel Mounting as necessary from page F17. To add Type W Mounting Modules for 32S models add -W to end of catalog number. See page F69 for modifications.

③ CLE-743 supplied with (1) NO and (1) NC front mount auxiliary.

④ Catalog numbers with specific voltages (i.e. @ 575V) shaded in gray are suitable for use as a manual motor starter only because they are not Type E rated. See page F5 for ratings.

Non-Reversing Ecombo Starters with DC Coil, Series CA7 Contactor ②

Thermal Trip [A]	Magnetic Trip [A]	Typical Three Phase [HP]				Catalog Number ①
		200V	230V	460V	575V	
KTA9-32S - Standard Interrupting Capacity (14 x In)						
0.10...0.16A	2.2	~	~	~	~	CLE-709*E10-CA16B
0.16...0.25A	3.5	~	~	~	~	CLE-709*E10-CA25B
0.25...0.40A	5.6	~	~	~	~	CLE-709*E10-CA40B
0.40...0.63A	8.8	~	~	~	~	CLE-709*E10-CA63B
0.63...1.0A	14	~	~	1/2	1/2	CLE-709*E10-CB10B
1.0...1.6A	22	~	~	3/4	3/4	CLE-709*E10-CB16B
1.6...2.5A	35	1/2	1/2	1	1-1/2	CLE-709*E10-CB25B
2.5...4.0A	56	3/4	3/4	2	3	CLE-709*E10-CB40B
4.0...6.3A	88	1	1-1/2	3	5 ④	CLE-709*E10-CB63B
6.3...10A	140	2	2	5	7-1/2 ④	CLE-709*E10-CC10B
6.3...10A	140	3	3	7-1/2	7-1/2 ④	CLE-712*E10-CC10B
10...16A	224	3	5	10	10 ④	CLE-716*E10-CC16B
KTA9-40H – High Interrupting Capacity (14 x In)						
0.40...0.63A	8.8	~	~	~	~	CLE-709*E10-DA63B
0.63...1.0A	14	~	~	1/2	1/2	CLE-709*E10-DB10B
1.0...1.6A	22	~	~	3/4	3/4	CLE-709*E10-DB16B
1.6...2.5A	35	1/2	1/2	1	1-1/2	CLE-709*E10-DB25B
2.5...4.0A	56	3/4	3/4	2	3	CLE-709*E10-DB40B
4.0...6.3A	88	1	1-1/2	3	5	CLE-709*E10-DB63B
6.3...10A	140	2	2	5	7-1/2	CLE-709*E10-DC10B
6.3...10A	140	2	2	5	7-1/2	CLE-712*E10-DC10B
10...16A	224	3	5	10	10	CLE-716*E10-DC16B
14.5...20A	280	5	5	10	15 ④	CLE-723*E10-DC20B
18...25A	350	5	7-1/2	15	20 ④	CLE-723*E10-DC25B
23...29A	406	7-1/2	10	20	25 ④	CLE-730*E10-DC29B
26.5...32A	448	7-1/2	10	20	30 ④	CLE-730*E10-DC32B
30...36A	432	10	10	25	30 ④	CLE-737*E10-DC36B
34...40A	480	10	10	25	30 ④	CLE-737*E10-DC40B
KTA7-45H – High Interrupting Capacity (13 x In)						
6.3...10A	130	2	3	5	7-1/2	CLE-730*E10-FC10B-W ②
10...16A	208	3	5	10	10	CLE-730*E10-FC16B-W ②
14.5...20A	260	5	5	10	15	CLE-730*E10-FC20B-W ②
18...25A	325	7-1/2	7-1/2	15	20	CLE-730*E10-FC25B-W ②
23...32A	416	7-1/2	10	20	25	CLE-730*E10-FC32B-W ②
32...45A	585	10	10	25	30	CLE-737*E10-FC45B-W ②
32...45A	585	10	15	30	30	CLE-743*E11-FC45C-W ② ③



Includes:

- KT9 Motor Controller with 1 NO Auxiliary Contact
- CA7 Contactor (DC)
- Connecting Module (Cat.# KT9-32S or 40H-PEC23)
- Terminal Adaptor for Type E/F Applications
- Can mount on one DIN-rail

Optional: ②

- Type W Mounting Module is optional on 32S & 40H. Type W Module is standard on C26 to C29 and 45H models. See modifications on page F1.48.

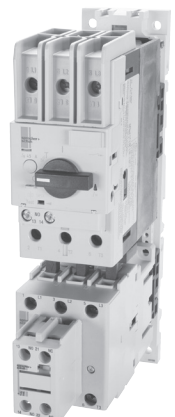

For applications above 45 amps please consider open type combination starters on page C59.

Coil Codes (*) ①

DC Coil Codes	Voltage
012	12V
024	24V
036	36-48V
048	48-72V
110	110-125V
220	220-250V

Horsepower ratings shown in the tables are for reference only. The final selection of the controller depends on the actual motor full load current and service factor.

- For motor with service factor less than 1.15. Use motor nameplate full load current times 0.9 and choose the motor starter with the appropriate current range. Example: Motor F.L.C. = 4.2A; S.F. = 1.0. – 4.2A x 0.9 = 3.78A. Select Catalog Number KTA9-32S-4.0A.

Ordering Instructions

Specify Catalog Number	
Replace (*) with Coil Code	See Coil Code table on this page for codes.

- ① Other voltages available, see Section A in this catalog.
- ② CLE-730...743 with KTA7-45H include Type W Mounting Modules for 35mm or 70mm DIN rail or Panel Mounting as necessary from page F17. To add Type W Mounting Modules for 32S models add -W to end of catalog number. See page F1.48 for modifications.
- ③ CLE-743 supplied with (1) NO and (1) NC front mount auxiliary.
- ④ Catalog numbers with specific voltages (i.e. @ 575V) shaded in gray are suitable for use as a manual motor starter only because they are not Type E rated. See page F5 for ratings.

Reversing Ecombo Starters with AC Coil, Series CA7 Contactor ②

Thermal Trip [A]	Magnetic Trip [A]	Typical Three Phase [HP]				Catalog Number ①
		200V	230V	460V	575V	
KTA9-32S - Standard Interrupting Capacity (14 x In)						
0.10...0.16A	2.2	~	~	~	~	CLUE-709*22-CA16B
0.16...0.25A	3.5	~	~	~	~	CLUE-709*22-CA25B
0.25...0.40A	5.6	~	~	~	~	CLUE-709*22-CA40B
0.40...0.63A	8.8	~	~	~	~	CLUE-709*22-CA63B
0.63...1.0A	14	~	~	1/2	1/2	CLUE-709*22-CB10B
1.0...1.6A	22	~	~	3/4	3/4	CLUE-709*22-CB16B
1.6...2.5A	35	1/2	1/2	1	1-1/2	CLUE-709*22-CB25B
2.5...4.0A	56	3/4	3/4	2	3	CLUE-709*22-CB40B
4.0...6.3A	88	1	1-1/2	3	5 ④	CLUE-709*22-CB63B
6.3...10A	140	2	2	5	7-1/2 ④	CLUE-709*22-CC10B
6.3...10A	140	3	3	7-1/2	7-1/2 ④	CLUE-712*22-CC10B
10...16A	224	3	5	10	10 ④	CLUE-716*22-CC16B
KTA9-40H - High Interrupting Capacity (14 x In)						
0.40...0.63A	8.8	~	~	~	~	CLUE-709*22-DA63B
0.63...1.0A	14	~	~	1/2	1/2	CLUE-709*22-DB10B
1.0...1.6A	22	~	~	3/4	3/4	CLUE-709*22-DB16B
1.6...2.5A	35	1/2	1/2	1	1-1/2	CLUE-709*22-DB25B
2.5...4.0A	56	3/4	3/4	2	3	CLUE-709*22-DB40B
4.0...6.3A	88	1	1-1/2	3	5	CLUE-709*22-DB63B
6.3...10A	140	2	2	5	7-1/2	CLUE-709*22-DC10B
6.3...10A	140	2	2	5	7-1/2	CLUE-712*22-DC10B
10...16A	224	3	5	10	10	CLUE-716*22-DC16B
14.5...20A	280	5	5	10	15 ④	CLUE-723*22-DC20B
18...25A	350	5	7-1/2	15	20 ④	CLUE-723*22-DC25B
23...29A	406	7-1/2	10	20	25 ④	CLUE-730*22-DC29B ②
26.5...32A	448	7-1/2	10	20	30 ④	CLUE-730*22-DC32B ②
30...36A	432	10	10	25	30 ④	CLUE-737*22-DC36B ②
34...40A	480	10	10	25	30 ④	CLUE-737*22-DC40B ②
KTA7-45H - High Interrupting Capacity (13 x In)						
6.3...10A	130	2	3	5	7.5	CLUE-730*22-FC10B-W ②
10...16A	208	3	5	10	10	CLUE-730*22-FC16B-W ②
14.5...20A	260	5	5	10	15	CLUE-730*22-FC20B-W ②
18...25A	325	7.5	7.5	15	20	CLUE-730*22-FC25B-W ②
23...32A	416	7.5	10	20	25	CLUE-730*22-FC32B-W ②
32...45A	585	10	10	25	30	CLUE-737*22-FC45B-W ②
32...45A	585	10	15	30	30	CLUE-743*22-FC45C-W ②③

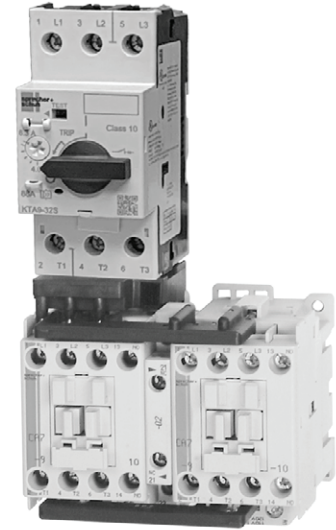

Includes:

- KT9 Motor Controller with 1 NO Auxiliary Contact
- Two CA7 Contactors (AC)
- Connecting Module (Cat.# KT9-32S or 40H-PEC23)
- Terminal Adaptor for Type E/F Applications
- Reversing Power Wiring Kit (Cat.# CAUT7-PW23)
- Electrical / Mechanical Interlock
- Can mount on one DIN-rail

Optional: ②

- Type W Mounting Module is optional on 32S & 40H. Type W Module is standard on C29...C40 and 45H models. See modifications on page F69.

Coil Codes (*) ①

AC Coil Code	Voltage Range	
	50 Hz	60 Hz
024Z	24V	24V
0120	110V	120V
220W	200-220V	208-240V
230Z	230V	230V
0277	240V	277V
0415	400-415V	~
0480 ⑤	440V	480V
0600 ⑤	550V	600V

Horsepower ratings shown in the tables are for reference only. **The final selection of the controller depends on the actual motor full load current and service factor.**

- For motor with service factor less than 1.15. Use motor nameplate full load current times 0.9 and choose the motor starter with the appropriate current range. Example: Motor F.L.C. = 4.2A; S.F. = 1.0. - 4.2A x 0.9 = 3.78A. Select Catalog Number KTA9-32S-4.0A.

Ordering Instructions

Specify Catalog Number	
Replace (*) with Coil Code	See Coil Code table on this page for codes.

- ① Other voltages available, see Section A in this catalog.
- ② CLUE-730...743 with KTA9-40H and KTA7-45H include Type W Mounting Modules for 35mm or 70mm DIN rail or Panel Mounting as necessary from page F17
- ③ CLUE-743 supplied with (1) NO and (1) NC front mount auxiliary per contactor.
- ④ Catalog numbers with specific voltages (i.e. @ 575V) shaded in gray are suitable for use as a manual motor starter only because they are not Type E rated. See page F5 for ratings.

Reversing Ecombo Starters with DC Coil, Series CA7 Contactor ②

Thermal Trip [A]	Magnetic Trip [A]	Typical Three Phase [HP]				Catalog Number ①
		200V	230V	460V	575V	
KTA9-32S - Standard Interrupting Capacity (14 x In)						
0.10...0.16A	2.2	~	~	~	~	CLUE-709*E22-CA16B
0.16...0.25A	3.5	~	~	~	~	CLUE-709*E22-CA25B
0.25...0.40A	5.6	~	~	~	~	CLUE-709*E22-CA40B
0.40...0.63A	8.8	~	~	~	~	CLUE-709*E22-CA63B
0.63...1.0A	14	~	~	1/2	1/2	CLUE-709*E22-CB10B
1.0...1.6A	22	~	~	3/4	3/4	CLUE-709*E22-CB16B
1.6...2.5A	35	1/2	1/2	1	1-1/2	CLUE-709*E22-CB25B
2.5...4.0A	56	3/4	3/4	2	3	CLUE-709*E22-CB40B
4.0...6.3A	88	1	1-1/2	3	5 ④	CLUE-709*E22-CB63B
6.3...10A	140	2	2	5	7-1/2 ④	CLUE-709*E22-CC10B
6.3...10A	140	3	3	7-1/2	7-1/2 ④	CLUE-712*E22-CC10B
10...16A	224	3	5	10	10 ④	CLUE-716*E22-CC16B
KTA9-40H - High Interrupting Capacity (14 x In)						
0.40...0.63A	8.8	~	~	~	~	CLUE-709*E22-DA63B
0.63...1.0A	14	~	~	1/2	1/2	CLUE-709*E22-DB10B
1.0...1.6A	22	~	~	3/4	3/4	CLUE-709*E22-DB16B
1.6...2.5A	35	1/2	1/2	1	1-1/2	CLUE-709*E22-DB25B
2.5...4.0A	56	3/4	3/4	2	3	CLUE-709*E22-DB40B
4.0...6.3A	88	1	1-1/2	3	5	CLUE-709*E22-DB63B
6.3...10A	140	2	2	5	7-1/2	CLUE-709*E22-DC10B
6.3...10A	140	2	2	5	7-1/2	CLUE-712*E22-DC10B
10...16A	224	3	5	10	10	CLUE-716*E22-DC16B
14.5...20A	280	5	5	10	15 ④	CLUE-723*E22-DC20B
18...25A	350	5	7-1/2	15	20 ④	CLUE-723*E22-DC25B
23...29A	406	7-1/2	10	20	25 ④	CLUE-730*E22-DC29B ②
26.5...32A	448	7-1/2	10	20	30 ④	CLUE-730*E22-DC32B ②
30...36A	432	10	10	25	30 ④	CLUE-737*E22-DC36B ②
34...40A	480	10	10	25	30 ④	CLUE-737*E22-DC40B ②
KTA7-45H - High Interrupting Capacity (13 x In)						
6.3...10A	130	2	3	5	7.5	CLUE-730*E22-FC10B-W ②
10...16A	208	3	5	10	10	CLUE-730*E22-FC16B-W ②
14.5...20A	260	5	5	10	15	CLUE-730*E22-FC20B-W ②
18...25A	325	7.5	7.5	15	20	CLUE-730*E22-FC25B-W ②
23...32A	416	7.5	10	20	25	CLUE-730*E22-FC32B-W ②
32...45A	585	10	10	25	30	CLUE-737*E22-FC45B-W ②
32...45A	585	10	15	30	30	CLUE-743*E22-FC45C-W ②⑥

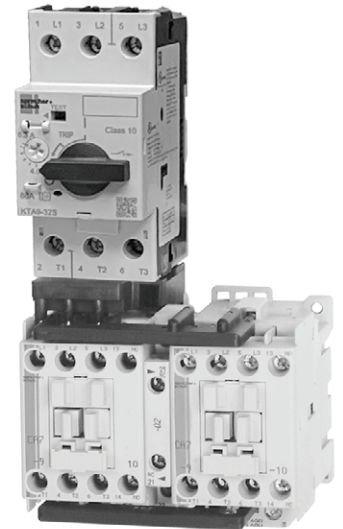

Includes:

- KT9 Motor Controller with 1 NO Auxiliary Contact
- Two CA7 Contactors (DC)
- Connecting Module (Cat.# KT9-32S or 40H-PEC23)
- Terminal Adaptor for Type E/F Applications
- Reversing Power Wiring Kit (Cat.# CAUT7-PW23)
- Electrical / Mechanical Interlock
- Can mount on one DIN-rail

Optional: ②

- Type W Mounting Module is optional on 32S & 40H. Type W Module is standard on C29...C40 and 45H models. See modifications on page F1.48.

F Ecombo Circuit Controllers

Coil Codes (*) ①

DC Coil Codes	Voltage
012	12V
024	24V
036	36-48V
048	48-72V
110	110-125V
220	220-250V

Horsepower ratings shown in the tables are for reference only. The final selection of the controller depends on the actual motor full load current and service factor.

- For motor with service factor less than 1.15. Use motor nameplate full load current times 0.9 and choose the motor starter with the appropriate current range. Example: Motor F.L.C. = 4.2A; S.F. = 1.0. - 4.2A x 0.9 = 3.78A. Select Catalog Number KTA9-32S-4.0A.

Ordering Instructions

Specify Catalog Number	
Replace (*) with Coil Code	See Coil Code table on this page for codes.

- ① Other voltages available, see Section A in this catalog.
- ② CLUE-730...743 with KTA9-40H and KTA7-45H include Type W Mounting Modules for 35mm or 70mm DIN rail or Panel Mounting as necessary from page F17
- ③ CLUE-743 supplied with (1) NO and (1) NC front mount auxiliary per contactor.
- ④ Catalog numbers with specific voltages (i.e. @ 575V) shaded in gray are suitable for use as a manual motor starter only because they are not Type E rated. See page F5 for ratings.

CLE and CLUE Modifications ③

Modification	Change Last Digit in Catalog Number to: ❶
KT9 Auxiliary (Front Mount 250VAC max.) and Trip Contacts	
Auxiliary Contact 1 NO (CL_-8 only)	B
Auxiliary Contact 1 NC	A
Auxiliary Contact 1 NO + 1 NC	C
Auxiliary Contact 2 NO	D
1 NO SC or OL + 1 NC Auxiliary Contact	R
1 NO SC or OL + 1 NO Auxiliary Contact	S
1 NC SC or OL + 1 NO Auxiliary Contact	T
KT9 Auxiliary (Side Mount 600VAC max.) and Trip Contacts	
Auxiliary Contact 2 NC	E

CLE and CLUE Additions ③

Add desired suffix AFTER auxiliary contact option code.

Addition	Add Suffix to Catalog Number:
Accessories	
Electronic Interfaces (CA7)	-JE ❷
Lockable Twist Knob (KT9) - Black	-KN
Lockable Twist Knob (KT9) - Red/Yellow	-KY
Type W Mounting Module for CLE-709...723 includes 45mm short module (W-32489)	-W
Type W Mounting Module for CLUE-709...723 includes 45mm (W-32849) and 54mm (W-32490) short module	-W
Additional KT9 Trip Contacts (Side Mount)	
1 NO SC or OL + 1 NO SC	-R00
1 NO SC or OL + 1 NC SC	-R01
1 NC SC or OL + 1 NO SC	-R10
1 NC SC or OL + 1 NC SC	-R11
1 NO SC + 1 NC SC	-M11

F
ECombo Circuit Controllers

❶ For CLE-8... or CLUE-8..., change last digit "X" to one of the modifications listed. Example: – CLE-809*10-CA16X changes to CLE-809*10-CA16B.
For CLE-7... or CLUE-7..., change last digits "B" to one of the modifications listed. Example: CLE-709*10-CA16B changes to CLE-709*10-CA16C.

❷ CRI7E-24 will be used. CRI7E-12 by special order only.

❸ See pages A47 for limitations on adding auxiliaries to Electronic DC Coil contactors.

Non-Reversing 3-Component Ecombo Starters ③④

Rated Oper. Current [A] ⑥	Overload Adj. Range [A]	Magnetic Trip [A]	Typical Three Phase [HP]				Catalog Number ②
			200V	230V	460V	575V	
KTB9-40H – High Interrupting Capacity (14 x In)							
0.63	1.0...5.0	8.8	~	~	~	~	CLE-709*10-DA63B-FCB
1.0	1.0...5.0	14	~	~	1/2	1/2	CLE-709*10-DB10B-FCB
1.6	1.0...5.0	22	~	~	3/4	3/4	CLE-709*10-DB16B-FCB
2.5	1.0...5.0	35	1/2	1/2	1	1-1/2	CLE-709*10-DB25B-FCB
4.0	1.0...5.0	52	3/4	3/4	2	3	CLE-709*10-DB40B-FCB
6.3	3.2...16	88	1	1-1/2	3	5	CLE-709*10-DB63B-FDB
10	3.2...16	130	2	2	5	7-1/2	CLE-709*10-DC10B-FDB
16	5.4...27	208	3	3	7-1/2	10	CLE-712*10-DC16B-FEB
20	5.4...27	280	5	5	10	~	CLE-723*10-DC20B-FEB
25	5.4...27	325	5	7-1/2	15	~	CLE-723*10-DC25B-FEB
29	11...55	406	7-1/2	10	20	~	CLE-730*10-DC29B-FFD
32	11...55	448	7-1/2	10	20	~	CLE-730*10-DC32B-FFD
KTB7-45H – High Interrupting Capacity (13 x In)							
25	5.4...27	325	5	7-1/2	15	20	CLE-730*10-FC25B-FED
32	11...55	416	7-1/2	10	20	25	CLE-730*10-FC32B-FFD
32	11...55	416	7-1/2	10	20	25	CLE-737*10-FC32B-FFD
45	11...55	585	10	10	25	30	CLE-737*10-FC45B-FFD
45	11...55	585	10	15	30	~	CLE-743*11-FC45C-FFD



Includes:

- KTB9 Motor Controller
- CA7 Contactor (AC)
- CEP7 Solid State Overload Relay
- KT9 Connectors
- Terminal Adaptor for Type E Applications
- Mounting Modules for 40H or 45H Frame Units as required from page F17
- See page F72 for Factory Options

Coil Codes (*) ①

AC Coil Code	Voltage Range	
	50 Hz	60 Hz
024Z	24V	24V
0120	110V	120V
220W	200-220V	208-240V
230Z	230V	230V
0277	240V	277V
0415	400-415V	~
0480 ⑥	440V	480V
0600 ⑥	550V	600V

Ordering Instructions

Specify Catalog Number	
Replace (*) with Coil Code	See Coil Code table on this page for codes.

- ① KAIC Assembly Rating Index. See pages F73-F76 for Application Rating Guide.
- ② Other voltages available, see Section A in this catalog.
- ③ All CLE are supplied with Auxiliary Contacts for customer use as follows:
 CLE-709...723 (1) NO Internal Mount
 CLE-730...737 (1) NO Side Mount
 CLE-743 (1) NO & (1) NC Front Mount
 All KTB9s are supplied with (1) NO auxiliary contact, which should be used in series with the NC contact on the overload (95-96).
- ④ Horsepower ratings shown in tables are for reference only. **The final selection of the controller and solid state overload relay depends on the actual motor full load current and service factor.**
- ⑤ The KTB9 Motor Circuit Controller is designed and tested to protect a motor circuit in case of a shortcircuit. A separate Sprecher + Schuh CEP7-1EF overload relay with selectable trip class should be used to protect the motor against overload. In Applications with motor starting times exceeding 10 seconds (heavy duty starting) the rated operational current (Ie) of the motor FLA must be multiplied by the following factors for selection of the KTB9 Motor Circuit Controller KTB9-40H and KTB7-45H.
 Trip classes according to UL 508 Section 52 and IEC 60947-4-1
 CLASS 10 = 1.0, CLASS 15 = 1.22, CLASS 20 = 1.42, CLASS 25 = 1.58, CLASS 30 = 1.7
 The maximum number of motor starts in 25 cycles/hour with a minimum OFF-time of 120 seconds between cycles. This additional calculation and selecting a larger frame size is necessary to compensate (dissipate) the increased heat resulting from long acceleration applications effecting the rated operational current of the KTB9.

Reversing 3-Component Ecombo Starters ③④⑤

Rated Oper. Current [A] ⑥	Overload Adj. Range [A]	Magnetic Trip [A]	Typical Three Phase [HP]				Catalog Number ②④⑦
			200V	230V	460V	575V	
KTB9-40H – High Interrupting Capacity (14 x In)							
0.63	1.0...5.0	8.8	~	~	~	~	CLUE-709*10-DA63B-FCB
1.0	1.0...5.0	14	~	~	1/2	1/2	CLUE-709*10-DB10B-FCB
1.6	1.0...5.0	22	~	~	3/4	3/4	CLUE-709*10-DB16B-FCB
2.5	1.0...5.0	35	1/2	1/2	1	1-1/2	CLUE-709*10-DB25B-FCB
4.0	1.0...5.0	52	3/4	3/4	2	3	CLUE-709*10-DB40B-FCB
6.3	3.2...16	88	1	1-1/2	3	5	CLUE-709*10-DB63B-FDB
10	3.2...16	130	2	2	5	7-1/2	CLUE-709*10-DC10B-FDB
16	5.4...27	208	3	3	7-1/2	10	CLUE-712*10-DC16B-FEB
20	5.4...27	280	5	5	10	~	CLUE-723*10-DC20B-FEB
25	5.4...27	325	5	7-1/2	15	~	CLUE-723*10-DC25B-FEB
29	11...55	406	7-1/2	10	20	~	CLUE-730*10-DC29B-FFD
32	11...55	448	7-1/2	10	20	~	CLUE-730*10-DC32B-FFD
KTB7-45H – High Interrupting Capacity (13 x In)							
25	5.4...27	325	5	7-1/2	15	20	CLUE-730*22-FC25B-FED
32	11...55	416	7-1/2	10	20	25	CLUE-730*22-FC32B-FFD
32	11...55	416	7-1/2	10	20	25	CLUE-737*22-FC32B-FFD
45	11...55	585	10	10	25	30	CLUE-737*22-FC45B-FFD
45	11...55	585	10	15	30	~	CLUE-743*22-FC45B-FFD

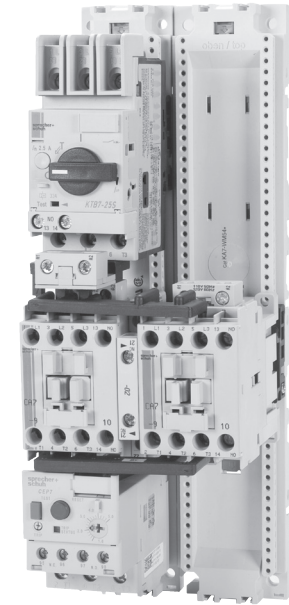

Includes:

- KTB9 Motor Controller
- CAU7 Reversing Contactor (AC)
- CEP7 Solid State Overload Relay
- KT9 Connectors
- Terminal Adaptor for Type E Applications
- Mounting Modules for 40H or 45H Frame Units as required from page F17
- See page F72 for Factory Options

Coil Codes (*) ①

AC Coil Code	Voltage Range	
	50 Hz	60 Hz
024Z	24V	24V
0120	110V	120V
220W	200-220V	208-240V
230Z	230V	230V
0277	240V	277V
0415	400-415V	~
0480 ⑥	440V	480V
0600 ⑥	550V	600V

Ordering Instructions

Specify Catalog Number	
Replace (*) with Coil Code	See Coil Code table on this page for codes.

- ① KAIC Assembly Rating Index. See pages F73-F76 for Application Rating Guide.
- ② Other voltages available, see Section A in this catalog.
- ③ All CLUE are supplied with Auxiliary Contacts for customer use as follows;
 - CLUE-709...723 (1) NO Internal Mount
 - CLUE-730...737 (1) NO Side Mount
 - CLUE-743 (1) NO & (1) NC Front Mount
 - CM7-02 interlock (2) NC (Electrical Interlocks)
 All KTB9s are supplied with (1) NO auxiliary contact (A10), which should be used in series with the NC contact on the overload (95-96).
- ④ All CAU7 reversing contactors are supplied with CM7-02, including (2) NC contacts for electronic interlocking (not available for customer use).
- ⑤ Horsepower ratings shown in tables are for reference only. **The final selection of the controller and solid state overload relay depends on the actual motor full load current and service factor.**
- ⑥ The KTB9 Motor Circuit Controller is designed and tested to protect a motor circuit in case of a short circuit. A separate Sprecher + Schuh CEP7-1EF overload relay with selectable trip class should be used to protect the motor against overload. In Applications with motor starting times exceeding 10 seconds (heavy duty starting) the rated operational current (Ie) of the motor FLA must be multiplied by the following factors for selection of the KTB9 Motor Circuit Controller KTB9-40H and KTB7-45H.
 - Trip classes according to UL 508 Section 52 and IEC 60947-4-1
 - CLASS 10 = 1.0, CLASS 15 = 1.22, CLASS 20 = 1.42, CLASS 25 = 1.58, CLASS 30 = 1.73
 The maximum number of motor starts in 25 cycles/hour with a minimum OFF-time of 120 seconds between cycles. This additional calculation and selecting a larger frame size is necessary to compensate (dissipate) the increased heat resulting from long acceleration applications effecting the rated operational current of the KTB9.

KT9 Assembly – Application Rating Chart (Ratings are dependent on type of application) ①

KT9	UL 60947-4-1						UL Type 4-1 Type F		
	Max. Fuse or Circuit Breaker per NEC [A]	Minimum Contactor Size	Group Motor Installation		Motor Disconnect		Combination Motor Controller		
			Max. Short-Circuit Current [kA]		Max. Short-Circuit Current [kA]		Minimum Contactor Size	Max. Short-Circuit Current [kA]	
			480V	600V	480V	600V		480Y/277V ①	600Y/347V ①
KTA9-32S + CA7 UL Assemblies (CLE) / (14 x In)									
KTA9-32S-0.16A	450	CA7-9	65	50	65	50	CA7-9	65	50
KTA9-32S-0.25A	450	CA7-9	65	50	65	50	CA7-9	65	50
KTA9-32S-0.40A	450	CA7-9	65	50	65	50	CA7-9	65	50
KTA9-32S-0.63A	450	CA7-9	65	50	65	50	CA7-9	65	50
KTA9-32S-1.0A	450	CA7-9	65	50	65	50	CA7-9	65	50
KTA9-32S-1.6A	450	CA7-9	65	50	65	50	CA7-9	65	50
KTA9-32S-2.5A	450	CA7-9	65	30	65	30	CA7-9	65	30
KTA9-32S-4.0A	450	CA7-9	65	30	65	30	CA7-9	65	30
KTA9-32S-6.3A	450	CA7-9	65	30	65	30	CA7-9	65	~
KTA9-32S-10A	450	CA7-9	65	30	65	30	CA7-9	65	~
KTA9-32S-16A	450	CA7-12	30	30	30	30	CA7-12	30	~
KTA9-32S-20A	450	CA7-23	30	30	30	10	~	~	~
KTA9-32S-25A	450	CA7-23	30	18	10	5	~	~	~
KTA9-32S-25A	450	CA7-30	30	18	30	5	~	~	~
KTA9-32S-29A	450	CA7-30	30	10	10	~	~	~	~
KTA9-32S-32A	450	CA7-37	30	10	10	~	~	~	~
KTA9-40H + CA7 UL Assemblies (CLE) / (14 x In)									
KTA9-40H-0.63A	450	CA7-9	65	50	65	50	CA7-9	65	50
KTA9-40H-1.0A	450	CA7-9	65	50	65	50	CA7-9	65	50
KTA9-40H-1.6A	450	CA7-9	65	50	65	50	CA7-9	65	50
KTA9-40H-2.5A	450	CA7-9	65	30	65	30	CA7-9	65	30
KTA9-40H-4.0A	450	CA7-9	65	30	65	30	CA7-9	65	30
KTA9-40H-6.3A	450	CA7-9	65	30	65	30	CA7-9	65	30
KTA9-40H-10A	450	CA7-9	65	30	65	30	CA7-9	65	30
KTA9-40H-16A	450	CA7-12	65	30	65	30	CA7-12	65	30
KTA9-40H-20A	450	CA7-23	65	30	65	30	CA7-23	65	~
KTA9-40H-25A	450	CA7-23	50	30	50	30	CA7-23	50	~
KTA9-40H-29A	450	CA7-30	50	30	50	30	CA7-30	50	~
KTA9-40H-32A	450	CA7-37	50	30	50	18	CA7-37	30	~
KTA9-40H-36A	450	CA7-37	30	30	30	18	CA7-37	30	~
KTA9-40H-40A	450	CA7-37	30	30	30	18	CA7-37	30	~
KTA7-45H + CA7 UL Assemblies (CLE) / (13 x In)									
KTA7-45H-10A	600	CA7-30	65	30	65	30	CA7-30	65	30
KTA7-45H-16A	600	CA7-30	65	30	65	30	CA7-30	65	30
KTA7-45H-20A	600	CA7-30	65	30	65	30	CA7-30	65	30
KTA7-45H-25A	600	CA7-30	65	30	65	30	CA7-30	65	30
KTA7-45H-32A	600	CA7-30	65	30	65	30	CA7-30	65	30
KTA7-45H-45A	600	CA7-37	65	18	65	18	CA7-37	65	~

① The ratings in these tables assume connection between components are made with Sprecher + Schuh Connection Modules. Engineering Practice allows wire connection as an alternative.

UL 60947 Application Ratings, MPCBs' with Series CA8 Contactors

KT9	UL 60947-4-1						UL Type 4-1 Type F		
	Max. Fuse or Circuit Breaker per NEC [A]	Minimum Contactor Size	Group Motor Installation		Motor Disconnect		Combination Motor Controller		
			Max. Short-Circuit Current [kA]		Max. Short-Circuit Current [kA]		Minimum Contactor Size	Max. Short-Circuit Current [kA]	
			480V	600V	480V	600V		480Y/277V ①	600Y/347V ①
KTA9-32S + CA8 UL Assemblies (CLE) / (14 x In)									
KTA9-32S-0.16A	450	CA8-09	65	47	65	50	CA8-09	65	30
KTA9-32S-0.25A	450	CA8-09	65	47	65	50	CA8-09	65	30
KTA9-32S-0.40A	450	CA8-09	65	47	65	50	CA8-09	65	30
KTA9-32S-0.63A	450	CA8-09	65	47	65	50	CA8-09	65	30
KTA9-32S-1.0A	450	CA8-09	65	47	65	50	CA8-09	65	30
KTA9-32S-1.6A	450	CA8-09	65	47	65	50	CA8-09	65	30
KTA9-32S-2.5A	450	CA8-09	65	47	65	30	CA8-09	65	30
KTA9-32S-4.0A	450	CA8-09	65	30	65	30	CA8-09	65	30
KTA9-32S-6.3A	450	CA8-09	65	30	65	30	CA8-09	65	50
KTA9-32S-10A	450	CA8-09	65	30	65	30	CA8-09	65	50
KTA9-32S-16A	450	CA8-12	30	30	30	30	CA8-12	65	50
KTA9-40H + CA8 UL Assemblies (CLE) / (14 x In)									
KTA9-40H-0.63A	450	CA8-09	65	50	65	50	~	65	30
KTA9-40H-1.0A	450	CA8-09	65	50	65	50	~	65	30
KTA9-40H-1.6A	450	CA8-09	65	50	65	50	~	65	30
KTA9-40H-2.5A	450	CA8-09	65	30	65	30	~	65	30
KTA9-40H-4.0A	450	CA8-09	65	30	65	30	~	65	30
KTA9-40H-6.3A	450	CA8-09	65	30	65	30	~	65	50
KTA9-40H-10A	450	CA8-09	65	30	65	30	~	65	50
KTA9-40H-16A	450	CA8-12	65	30	65	30	~	65	50

UL 60947 Application Ratings, MPCBs' with Series CA7 Contactors

KT9	UL 60947-4-1					
	Max. Fuse or Circuit Breaker per NEC [A]	Minimum Contactor Size	Group Motor Installation		Motor Disconnect	
			Max. Short-Circuit Current [kA]		Max. Short-Circuit Current [kA]	
			480V	600V	480V	600V
KT9-40H + CA7 UL Assemblies (CLE) / (14 x In)						
KT9-40H-0.16A	450	CA7-9	65	50	65	50
KT9-40H-0.25A	450	CA7-9	65	50	65	50
KT9-40H-0.40A	450	CA7-9	65	50	65	50
KT9-40H-0.63A	450	CA7-9	65	50	65	50
KT9-40H-1.0A	450	CA7-9	65	50	65	50
KT9-40H-1.6A	450	CA7-9	65	50	65	50
KT9-40H-2.5A	450	CA7-9	65	30	65	30
KT9-40H-4.0A	450	CA7-9	65	30	65	30
KT9-40H-6.3A	450	CA7-9	65	30	65	30
KT9-40H-10A	450	CA7-9	65	30	65	30
KT9-40H-16A	450	CA7-12	65	30	65	30
KT9-40H-20A	450	CA7-23	65	30	65	30
KT9-40H-25A	450	CA7-23	50	30	50	30
KT9-40H-29A	450	CA7-30	50	30	50	30
KT9-40H-32A	450	CA7-37	50	30	30	18
KT9-40H-36A	450	CA7-37	30	30	30	18
KT9-40H-40A	450	CA7-37	30	30	30	18
KT9-45H + CA7 UL Assemblies (CLE) / (14 x In)						
KT9-45H-25A	600	CA7-23	65	30	65	30
KT9-45H-32A	600	CA7-30	65	30	65	30
KT9-45H-45A	600	CA7-37	65	18	65	18

① The ratings in these tables assume connection between components are made with Sprecher + Schuh Connection Modules. Engineering Practice allows wire connection as an alternative.

Type 2 Coordination Ratings, MPCBs' with Series CA7 Contactors

Cat. No.			400V		480V		600V	
Standard Motor Protection	High Inrush Motor Protection	Motor Circuit Protection	Max. Short-Circuit Current [kA]	Max. Short-Circuit Current [kA]	Max. Short-Circuit Current [kA]	Minimum Contactor Size	Max. Short-Circuit Current [kA]	Minimum Contactor Size
KTA9-32S + CA7 UL Assemblies (CLE) / (14 x In)								
KTA9-32S-0.16A	~	~	100	CA7-9	~	~	~	~
KTA9-32S-0.25A	~	~	100	CA7-9	~	~	~	~
KTA9-32S-0.40A	~	~	100	CA7-9	~	~	~	~
KTA9-32S-0.63A	~	~	100	CA7-9	~	~	~	~
KTA9-32S-1.0A	~	~	100	CA7-9	~	~	~	~
KTA9-32S-1.6A	~	~	100	CA7-9	~	~	~	~
KTA9-32S-2.5A	~	~	65	CA7-23	~	~	~	~
KTA9-32S-4.0A	~	~	65	CA7-23	~	~	~	~
KTA9-32S-6.3A	~	~	65	CA7-23	~	~	~	~
KTA9-32S-10A	~	~	65	CA7-23	~	~	~	~
KTA9-32S-16A	~	~	50	CA7-30	~	~	~	~
KTA9-32S-20A	~	~	50	CA7-30	~	~	~	~
KTA9-32S-25A	~	~	15	CA7-30	~	~	~	~
KTA9-32S-29A	~	~	15	CA7-30	~	~	~	~
KTA9-32S-32A	~	~	15	CA7-30	~	~	~	~
KT_9-40H + CA7 UL Assemblies (CLE) / (14 x In)								
KTA9-40H-0.63A	~	~	100	CA7-9	~	~	~	~
KTA9-40H-1.0A	KTC9-40H-0.63A	KTB9-40H-1.0A	100	CA7-9	~	~	~	~
KTA9-40H-1.6A	KTC9-40H-1.0A	KTB9-40H-1.6A	100	CA7-9	~	~	~	~
KTA9-40H-2.5A	KTC9-40H-1.6A	KTB9-40H-2.5A	100	CA7-9	~	~	~	~
KTA9-40H-4.0A	KTC9-40H-2.5A	KTB9-40H-4.0A	65	CA7-9	~	~	~	~
KTA9-40H-6.3A	KTC9-40H-4.0A	KTB9-40H-6.3A	65	CA7-9	~	~	~	~
KTA9-40H-10A	KTC9-40H-6.3A	KTB9-40H-10A	65	CA7-9	~	~	~	~
KTA9-40H-16A	KTC9-40H-10A	KTB9-40H-16A	65	CA7-23	~	~	~	~
KTA9-40H-20A	KTC9-40H-16A	KTB9-40H-20A	65	CA7-23	~	~	~	~
KTA9-40H-25A	KTC9-40H-20A	KTB9-40H-25A	50	CA7-23	~	~	~	~
KTA9-40H-29A	KTC9-40H-25A	KTB9-40H-29A	65	CA7-30	~	~	~	~
KTA9-40H-32A	KTC9-40H-29A	KTB9-40H-32A	65	CA7-30/37	~	~	~	~
KTA9-40H-36A	KTC9-40H-32A	~	65	CA7-30/37	~	~	~	~
KTA9-40H-40A	KTC9-40H-36A	KTB9-40H-40A	65	CA7-30/37	~	~	~	~
KT_7-45H + CA7 UL Assemblies (CLE) / (13 x In)								
KTA7-45H-10A	~	~	100	CA7-9	65	CA7-9	30	CA7-30
KTA7-45H-16A	~	~	100	CA7-12	65	CA7-12	30	CA7-30
KTA7-45H-20A	~	~	100	CA7-23	65	CA7-23	30	CA7-30
KTA7-45H-25A	~	KTB7-45H-25A	100	CA7-30	65	CA7-30	30	CA7-30
KTA7-45H-32A	KTC7-45H-25A	KTB7-45H-32A	100	CA7-30	65	CA7-30	30	CA7-30
KTA7-45H-45A	KTC7-45H-32A	KTB7-45H-45A	100	CA7-37	65	CA7-37	30	CA7-37

2-Component ECombo Starters

CLE Non-Reversing Typical Diagram

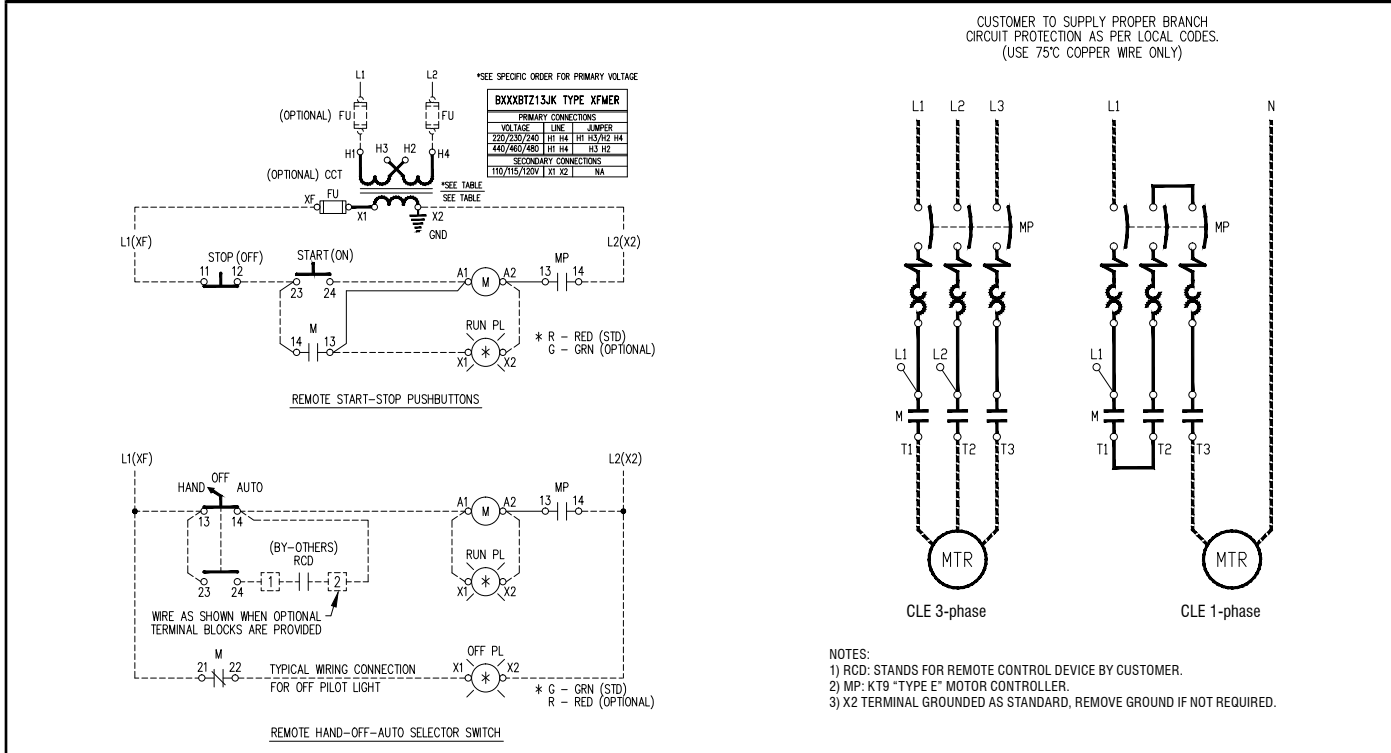

3-Component ECombo Starters

CLE + O/L Non-Reversing Typical Diagram

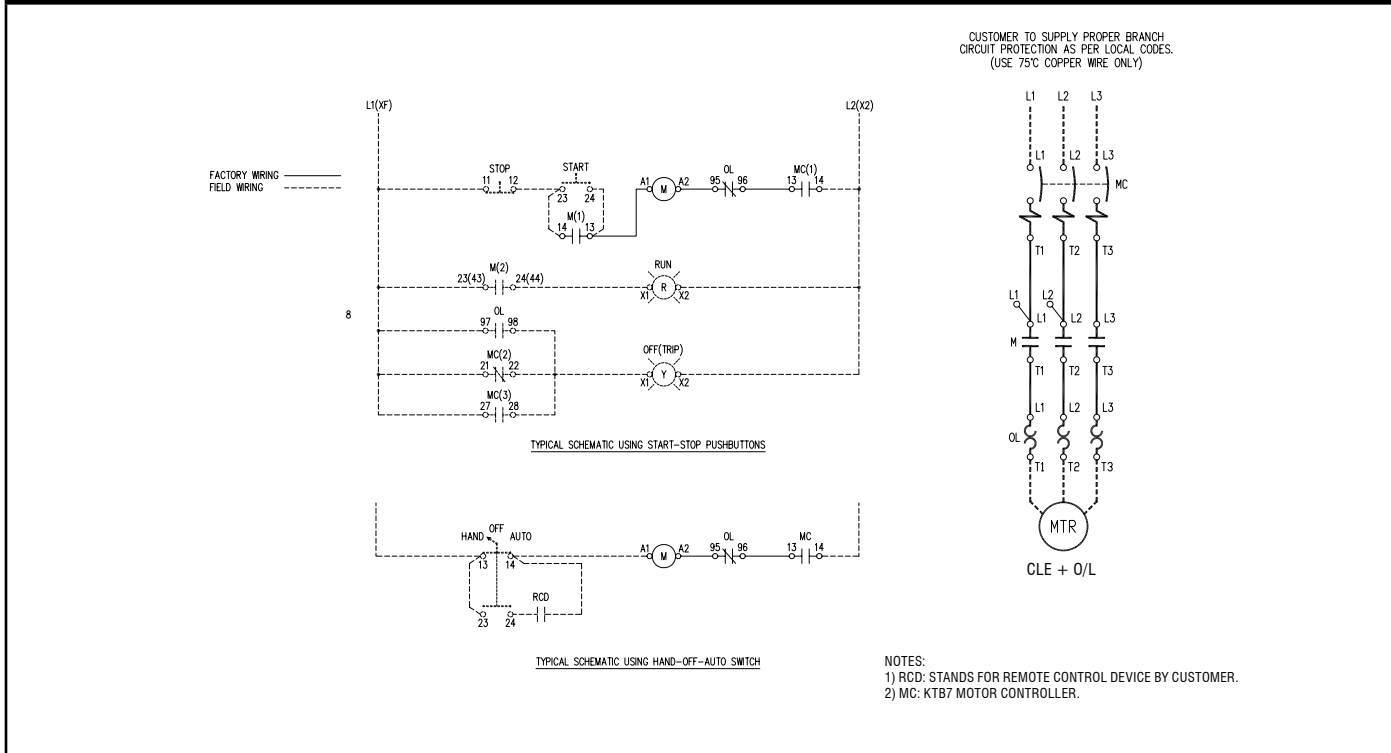

ECombo Circuit Controllers

Enclosed Motor Controllers and Molded Case Circuit Breakers



KTA9 Type-E Self Protected Manual Motor Controllers
Page F1.57



Explosion-Proof Motor Controllers



KTA9_EX
Page F1.61



KTA9_EZ
Page F1.62

The following pages contain a selection of single enclosed KTA9 & KTC9 motor controllers which can be applied as an individual Manual Self-Protected Combination Motor Controller or as an individual Manual Motor Starter dependent on the ratings of the individual unit.

- A Self-protected Combination Motor Controller (UL508 Construction Type E) performs all the functions of a Manual Combo starter including a UL approved means "Disconnect" with lockable and defeatable handle mechanism, short-circuit protection and overload protection for motor applications.
- A UL508 Manual Motor Controller is a manual motor starter including a motor disconnect combined with an overload relay.

Both can be combined with auxiliary contacts, shunt-trip or under-voltage trip units to meet your application requirements. The section that follows includes non-metallic enclosures, metallic enclosures and explosion-proof enclosures.

Enclosed Molded Case Circuit Breakers

The following pages contain a selection of individual enclosed KTU9 molded case circuit breakers for the protection of non-motor loads. KTU9 is a 480Y/277Volt or 600Y/347 volt UL489 approved circuit breaker and the selection of enclosures or combined with matching environmentally approved thru-the-door handle disconnect mechanism which also complies with UL489 standards. KTU9 offers at least 65 KAIC withstand ratings which exceeds those offered by many 600 Volt Class Molded Case Circuit Breakers which



KTU9 Molded Case Circuit Breakers
Page F1.63

are larger and more expensive. Enclosed KTU9 can be combined with auxiliary contacts, shunt-trip or under-voltage trip units to meet your application requirements.

Enclosed Type E/F Combination Starters

KTA9 or KTC9 can be applied in combination with a CA7 contactor for remote control and an enclosure with matching environmentally approved thru-the-door handle disconnect mechanism to meet all requirements for a Construction Type E or F Combination Starter. The following pages contain a selection of individual Combo starters which are smaller and less expensive than Classic Construction Type A (Fusible), or Type C (Thermal-magnetic Molded Case Circuit Breaker) as offered in Section C of this catalog. The following types are offered:



CX7 Ecombo KWIKStarter
Page F1.66

- Non-metallic enclosed Combo KwikStarter CX7 and CXU7 with AC or DC coils available as factory assembled or in kit form for field assembly
- Metallic enclosed Combo CX7 and CXU7 with AC or DC coils
- Explosion-proof enclosed CX7 and CXU7 with AC or DC coils

A variety of modifications are available.



CX7 Combination Controllers
Page F1.73

Enclosed KTA9 - IP66 - Type 4/4X/12K

Amp / Horsepower Rating				Non-metallic (IP65) Enclosure			
							
Max. Horsepower ①②③				O/L Relay Ampere Range	Magnetic Res. Current	Catalog Number ④	Dimension Code
Three Phase							
200V	230V	460V	575V				
KTA9-32S Standard Interrupting Capacity							
~	~	~	~	0.10...0.16	2.2	KTA9-32S-0.16A-CG	AY
~	~	~	~	0.16...0.25	3.5	KTA9-32S-0.25A-CG	AY
~	~	~	~	0.25...0.40	5.6	KTA9-32S-0.4A-CG	AY
~	~	~	~	0.40...0.63	8.8	KTA9-32S-0.63A-CG	AY
~	~	1/2	1/2	0.63...1.0	14	KTA9-32S-1.0A-CG	AY
~	~	3/4	~	1.0...1.6	22	KTA9-32S-1.6A-CG	AY
1/2	1/2	1	1-1/2	1.6...2.5	35	KTA9-32S-2.5A-CG	AY
3/4	3/4	2	3	2.5...4.0	52	KTA9-32S-4.0A-CG	AY
1	1-1/2	3	5 ⑥	4.0...6.3	88	KTA9-32S-6.3A-CG	AY
2	2	5	7-1/2 ⑥	6.3...10	140	KTA9-32S-10A-CG	AY
3	5	10	10 ⑥	10...16 ⑦	224	KTA9-32S-16A-CG	AY

Includes:

- Non-metallic (IP66 - Type 4/4X/12K) enclosure with integrated operator – watertight, dusttight
- KTA9-32S (Standard Interrupting Capacity) “Type E” Self-protected Combination Manual Controller ⑤
- Terminal Adaptor for Type E Applications (Cat.# KT9-40-TE)
- Gray and black handle ④⑤

Modifications (Factory Assembled)

Description	Add Suffix to Cat. Number
KT9 Auxiliaries & Trip Contacts, Front Mount 250V max. 1 NO Auxiliary 1 NC Auxiliary	-B -A -C -D -R -S
1 NO + 1 NC Auxiliary 2 NO Auxiliaries 1 NO SC+OL + 1 NC Auxiliary 1 NO SC+OL + 1 NO Auxiliary	
Side Mount 600V max. 2 NC Auxiliaries 2 NO Auxiliaries 1 NO + 1 NC Auxiliary	-AS02 -AS20 -AS11
Additional KT9 Trip Contacts, Side Mount 600V max. 1 NO SC+OL+1 NO SC 1 NO SC+OL+1 NC SC 1 NC SC+OL+1 NO SC	-R00 -R01 -R10
Accessories Undervoltage Release Module Shunt Release Module	-UA-* -AA-*

Enclosure Only - IP66 - Type 4/4X/12K

	Description	For use With	Catalog Number
	Gray/Black handle	KTA9-32S up to 13A	KT9-ENN
	Red/Yellow handle	KTA9-32S up to 13A	KT9-ENRY

① Horsepower ratings shown in the table above are for reference. *The final selection of the controller depends on the actual motor full load current and service factor.*

- For motor with service factor less than 1.15. Use motor nameplate full load current times 0.9 and choose the motor starter with the appropriate current range. Example: Motor FLC = 4.2A; S.F. = 1.0. 4.2A x 0.9 = 3.78A. Select catalog number KTA9-32S-4.0A.
- ② Magnetic trip is fixed at 14x the maximum value of the current adjustment range. Refer to page F5 for applied KAIC ratings.
- ③ KTA9 may be applied to single phase loads if 3 poles of device are wired in series. See footnote 1 for device selection criteria.
- ④ A red and yellow handle may be selected instead of the standard gray and black handle. Change “CG” suffix to “CJ”. Ex: Change KTA9-32S-0.16A-CG to KTA9-32S-0.16A-CJ.
- ⑤ Handles are built-in to the enclosure and are not available as components.
- ⑥ Catalog numbers with specific voltages (i.e. @ 575V) shaded in gray are suitable for use as a manual motor starter only because they are not Type E rated. See page F5 for ratings.
- ⑦ This device is 30 KAIC approved up to 13 amps.

-UA..AA Coil Codes (*)

AC Coil Code	Voltage Range	
	50 Hz	60 Hz
24V	24V	24V...28V
120V	110V	120V
230V	220...230V	~
260V	~	240...260V
277V	~	277V
400V	380...400V	~
480V	415V	480V

F
Enclosed Motor Circuit Controllers

Enclosed KTA9 - Type 4 / 4X / 12

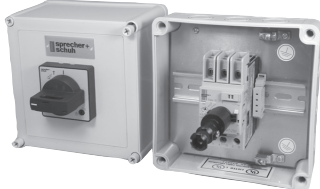
Amp / Horsepower Rating				Non-metallic, Type 4 / 4X / 12 Enclosure			
				O/L Relay Ampere Range	Magnetic Res. Current	Catalog Number ③	Dim Code
Three Phase							
200V	230V	460V	575V				
KTA9-32S Standard Interrupting Capacity							
~	~	~	~	0.10...0.16	2.2	KTA9-32S-0.16A-VG	Q5
~	~	~	~	0.16...0.25	3.5	KTA9-32S-0.25A-VG	Q5
~	~	~	~	0.25...0.40	5.6	KTA9-32S-0.40A-VG	Q5
~	~	~	~	0.40...0.63	8.8	KTA9-32S-0.63A-VG	Q5
~	~	1/2	1/2	0.63...1.0	14	KTA9-32S-1.0A-VG	Q5
~	~	3/4	~	1.0...1.6	22	KTA9-32S-1.6A-VG	Q5
1/2	1/2	1	1-1/2	1.6...2.5	35	KTA9-32S-2.5A-VG	Q5
3/4	3/4	2	3	2.5...4.0	52	KTA9-32S-4.0A-VG	Q5
1	1-1/2	3	5 ④	4.0...6.3	88	KTA9-32S-6.3A-VG ④	Q5
2	2	5	7-1/2 ④	6.3...10	140	KTA9-32S-10A-VG ④	Q5
3	5	10	10 ④	10...16	224	KTA9-32S-16A-VG ④	Q5
5 ④	5 ④	10 ④	15 ④	14.5...20	280	KTA9-32S-20A-VG ④	Q5
5 ④	7-1/2 ④	15 ④	20 ④	18...25	330	KTA9-32S-25A-VG ④	Q5
7-1/2 ④	10 ④	20 ④	25 ④	24...29	406	KTA9-32S-29A-VG ④	Q5
7-1/2 ④	10 ④	20 ④	30 ④	27...32	448	KTA9-32S-32A-VG ④	Q5
KTA9-40H High Interrupting Capacity							
~	~	~	~	0.40...0.63	8.8	KTA9-40H-0.63A-VG	Q6
~	~	1/2	1/2	0.63...1.0	14	KTA9-40H-1.0A-VG	Q6
~	~	3/4	~	1.0...1.6	22	KTA9-40H-1.6A-VG	Q6
1/2	1/2	1	1-1/2	1.6...2.5	33	KTA9-40H-2.5A-VG	Q6
3/4	3/4	2	3	2.5...4.0	52	KTA9-40H-4.0A-VG	Q6
1	1-1/2	3	5	4.0...6.3	82	KTA9-40H-6.3A-VG	Q6
2	2	5	7-1/2	6.3...10	130	KTA9-40H-10A-VG	Q6
3	5	10	10	10...16	208	KTA9-40H-16A-VG	Q6
5	5	10	15 ④	14.5...20	260	KTA9-40H-20A-VG ④	Q6
5	7-1/2	15	20 ④	18...25	325	KTA9-40H-25A-VG ④	Q6
7-1/2	10	20	25 ④	24...29	406	KTA9-40H-29A-VG ④	Q6
7-1/2	10	20	30 ④	27...32	448	KTA9-40H-32A-VG ④	Q6
10	10	25	30 ④	30...36	432	KTA9-40H-36A-VG ④	Q6
10	10	30	30 ④	34...40	480	KTA9-40H-40A-VG ④	Q6
KTA7-45H High Interrupting Capacity							
2	3	5	7-1/2	6.3...10	130	KTA7-45H-10A-VG	Q7
3	5	10	10	10...16	208	KTA7-45H-16A-VG	Q7
5	5	10	15	14.5...20	260	KTA7-45H-20A-VG	Q7
7-1/2	7-1/2	15	20	18...25	325	KTA7-45H-25A-VG	Q7
7-1/2	10	20	30	23...32	416	KTA7-45H-32A-VG	Q7
10	15	30	40 ④	32...45	585	KTA7-45H-45A-VG	Q7

Includes:

- Type 4 / 4X / 12 enclosure – watertight, dusttight, corrosion resistant
- KTA9 “Type E” Self-protected Combination Manual Controller (Standard Interrupting Capacity) ⑤
- Terminal Adaptor for Type E Applications (Cat.# KT9-40-TE or KT7-45-TE)
- Gray and black Type 4/4X/12; IP66 handle (Cat.# KT9-HTN) ④

Modifications (Factory Assembled)

Description	Add Suffix to Cat. Number
KT9 Auxiliaries & Trip Contacts, Front Mount 250V max.	
1 NO Auxiliary	-B
1 NC Auxiliary	-A
1 NO + 1 NC Auxiliary	-C
2 NO Auxiliaries	-D
1 NO SC+OL + 1 NC	-R
1 NO SC+OL + 1 NO	-S
Side Mount 600V max.	
2 NC Auxiliaries	-AS02
2 NO Auxiliaries	-AS20
1 NO + 1 NC Auxiliary	-AS11
Additional KT9 Trip Contacts, Side Mount 600V max.	
1 NO SC+OL+1 NO SC	-R00
1 NO SC+OL+1 NC SC	-R01
1 NC SC+OL+1 NO SC	-R10
Accessories	
Undervoltage Release Module	-UA-*
Shunt Release Module	-AA-*

-UA..-AA Coil Codes (*)

AC Coil Code	Voltage Range	
	50 Hz	60 Hz
24V	24V	24V...28V
120V	110V	120V
230V	220...230V	~
260V	~	240...260V
277V	~	277V
400V	380...400V	~
480V	415V	480V

① Horsepower ratings shown in the table above are for reference. The final selection of the controller depends on the actual motor full load current and service factor.

- For motor with service factor less than 1.15. Use motor nameplate full load current times 0.9 and choose the motor starter with the appropriate current range. Example: Motor FLC = 4.2A; S.F. = 1.0. 4.2A x 0.9 = 3.78A. Select catalog number KTA9-32S-4.0A.

② KTA9 may be applied to single phase loads if 3 poles of device are wired in series. See footnote 1 for device selection criteria.

④ A red and yellow handle may be selected instead of the standard gray and black handle. Change “VG” suffix to “VJ”. Ex: Change KTA9-32S-0.16-VG to KTA9-32S-0.16-VJ.

⑤ Catalog numbers with specific voltages (i.e. @ 575V) shaded in gray are suitable for use as a manual motor starter only because they are not Type E rated. See page F5 for ratings.

Enclosed KTA9 - Type 12

Amp / Horsepower Rating				Painted Steel, Type 12 Enclosure				Dim Code
Max. Horsepower ①②③				O/L Relay Ampere Range	Magnetic Res. Current	Catalog Number ④	Dim Code	
Three Phase								
200V	230V	460V	575V					
KTA9-32S Standard Interrupting Capacity								
~	~	~	~	0.10...0.16	2.2	KTA9-32S-0.16A-DG	L	
~	~	~	~	0.16...0.25	3.5	KTA9-32S-0.25A-DG	L	
~	~	~	~	0.25...0.40	5.6	KTA9-32S-0.40A-DG	L	
~	~	~	~	0.40...0.63	8.8	KTA9-32S-0.63A-DG	L	
~	~	1/2	1/2	0.63...1.0	14	KTA9-32S-1.0A-DG	L	
~	~	3/4	~	1.0...1.6	22	KTA9-32S-1.6A-DG	L	
1/2	1/2	1	1-1/2	1.6...2.5	35	KTA9-32S-2.5A-DG	L	
3/4	3/4	2	3	2.5...4.0	52	KTA9-32S-4.0A-DG	L	
1	1-1/2	3	5 ④	4.0...6.3	88	KTA9-32S-6.3A-DG ④	L	
2	2	5	7-1/2 ④	6.3...10	140	KTA9-32S-10A-DG ④	L	
3	5	10	10 ④	10...16	224	KTA9-32S-16A-DG ④	L	
5 ④	5 ④	10 ④	15 ④	14.5...20	280	KTA9-32S-20A-DG ④	L	
5 ④	7-1/2 ④	15 ④	20 ④	18...25	330	KTA9-32S-25A-DG ④	L	
7-1/2 ④	10 ④	20 ④	25 ④	24...29	406	KTA9-32S-29A-DG ④	L	
7-1/2 ④	10 ④	20 ④	30 ④	27...32	448	KTA9-32S-32A-DG ④	L	
KTA9-40H High Interrupting Capacity								
~	~	~	~	0.40...0.63	8.8	KTA9-40H-0.63A-DG	L	
~	~	1/2	1/2	0.63...1.0	14	KTA9-40H-1.0A-DG	L	
~	~	3/4	~	1.0...1.6	22	KTA9-40H-1.6A-DG	L	
1/2	1/2	1	1-1/2	1.6...2.5	33	KTA9-40H-2.5A-DG	L	
3/4	3/4	2	3	2.5...4.0	52	KTA9-40H-4.0A-DG	L	
1	1-1/2	3	5	4.0...6.3	82	KTA9-40H-6.3A-DG	L	
2	2	5	7-1/2	6.3...10	130	KTA9-40H-10A-DG	L	
3	5	10	10	10...16	208	KTA9-40H-16A-DG	L	
5	5	10	15 ④	14.5...20	260	KTA9-40H-20A-DG ④	L	
5	7-1/2	15	20 ④	18...25	325	KTA9-40H-25A-DG ④	L	
7-1/2	10	20	25 ④	24...29	406	KTA9-40H-29A-DG ④	L	
7-1/2	10	20	30 ④	27...32	448	KTA9-40H-32A-DG ④	L	
10	10	25	30 ④	30...36	432	KTA9-40H-36A-DG ④	L	
10	10	30	30 ④	34...40	480	KTA9-40H-40A-DG ④	L	

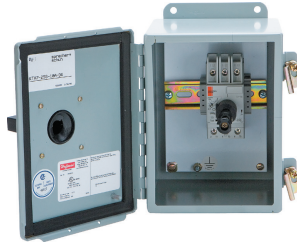

Includes:

- Type 12 enclosure – dusttight
- KTA9 “Type E” Self-protected Combination Manual Controller ⑤
- Terminal Adaptor for Type E Applications (Cat.# KT9-40-TE)
- Gray and black Type 4/4X/12; IP66 handle (Cat.# KT9-HTN) ④

Modifications (Factory Assembled)

Description	Add Suffix to Cat. Number
KT9 Auxiliaries & Trip Contacts, Front Mount 250V max.	
1 NO Auxiliary	-B
1 NC Auxiliary	-A
1 NO + 1 NC Auxiliary	-C
2 NO Auxiliaries	-D
1 NO SC+OL + 1 NC	-R
1 NO SC+OL + 1 NO	-S
Side Mount 600V max.	
2 NC Auxiliaries	-AS02
2 NO Auxiliaries	-AS20
1 NO + 1 NC Auxiliary	-AS11
Additional KT9 Trip Contacts, Side Mount 600V max.	
1 NO SC+OL+1 NO SC	-R00
1 NO SC+OL+1 NC SC	-R01
1 NC SC+OL+1 NO SC	-R10
Accessories	
Undervoltage Release Module	-UA-*
Shunt Release Module	-AA-*

-UA..-AA Coil Codes (*)

AC Coil Code	Voltage Range	
	50 Hz	60 Hz
24V	24V	24V...28V
120V	110V	120V
230V	220...230V	~
260V	~	240...260V
277V	~	277V
400V	380...400V	~
480V	415V	480V

① Horsepower ratings shown in the table above are for reference. The final selection of the controller depends on the actual motor full load current and service factor.

- For motor with service factor less than 1.15. Use motor nameplate full load current times 0.9 and choose the motor starter with the appropriate current range. Example: Motor FLC = 4.2A; S.F. = 1.0. 4.2A x 0.9 = 3.78A. Select catalog number KTA9-32S-4.0A.

② KTA9 may be applied to single phase loads if 3 poles of device are wired in series. See footnote 1 for device selection criteria.

④ A red and yellow handle may be selected instead of the standard gray and black handle. Change “DG” suffix to “DJ”. Ex: Change KTA9-32S-0.16-DG to KTA9-32S-0.16-DJ.

⑤ Catalog numbers with specific voltages (i.e. @ 575V) shaded in gray are suitable for use as a manual motor starter only because they are not Type E rated. See page F5 for ratings.

Enclosed KTA9 - Type 4 / 12

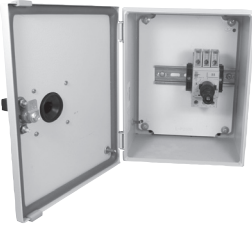
Amp / Horsepower Rating				Painted Steel, Type 4 / 12 Enclosure			
				O/L Relay Ampere Range	Magnetic Res. Current	Catalog Number ③	Dim Code
Three Phase							
200V	230V	460V	575V				
KTA9-32S Standard Interrupting Capacity							
~	~	~	~	0.10...0.16	2.2	KTA9-32S-0.16A-WG	W6
~	~	~	~	0.16...0.25	3.5	KTA9-32S-0.25A-WG	W6
~	~	~	~	0.25...0.40	5.6	KTA9-32S-0.40A-WG	W6
~	~	~	~	0.40...0.63	8.8	KTA9-32S-0.63A-WG	W6
~	~	1/2	1/2	0.63...1.0	14	KTA9-32S-1.0A-WG	W6
~	~	3/4	~	1.0...1.6	22	KTA9-32S-1.6A-WG	W6
1/2	1/2	1	1-1/2	1.6...2.5	35	KTA9-32S-2.5A-WG	W6
3/4	3/4	2	3	2.5...4.0	52	KTA9-32S-4.0A-WG	W6
1	1-1/2	3	5 ④	4.0...6.3	88	KTA9-32S-6.3A-WG ④	W6
2	2	5	7-1/2 ④	6.3...10	140	KTA9-32S-10A-WG ④	W6
3	5	10	10 ④	10...16	224	KTA9-32S-16A-WG ④	W6
5 ④	5 ④	10 ④	15 ④	14.5...20	280	KTA9-32S-20A-WG ④	W6
5 ④	7-1/2 ④	15 ④	20 ④	18...25	330	KTA9-32S-25A-WG ④	W6
7-1/2 ④	10 ④	20 ④	25 ④	24...29	406	KTA9-32S-29A-WG ④	W6
7-1/2 ④	10 ④	20 ④	30 ④	27...32	448	KTA9-32S-32A-WG ④	W6
KTA9-40H High Interrupting Capacity							
~	~	~	~	0.40...0.63	8.8	KTA9-40H-0.63A-VG	W6
~	~	1/2	1/2	0.63...1.0	14	KTA9-40H-1.0A-VG	W6
~	~	3/4	~	1.0...1.6	22	KTA9-40H-1.6A-VG	W6
1/2	1/2	1	1-1/2	1.6...2.5	33	KTA9-40H-2.5A-WG	W6
3/4	3/4	2	3	2.5...4.0	52	KTA9-40H-4.0A-WG	W6
1	1-1/2	3	5	4.0...6.3	82	KTA9-40H-6.3A-WG	W6
2	2	5	7-1/2	6.3...10	130	KTA9-40H-10A-WG	W6
3	5	10	10	10...16	208	KTA9-40H-16A-WG	W6
5	5	10	15 ④	14.5...20	260	KTA9-40H-20A-WG ④	W6
5	7-1/2	15	20 ④	18...25	325	KTA9-40H-25A-WG ④	W6
7-1/2	10	20	25 ④	24...29	406	KTA9-40H-29A-WG ④	W6
7-1/2	10	20	30 ④	27...32	448	KTA9-40H-32A-WG ④	W6
10	10	25	30 ④	30...36	432	KTA9-40H-36A-WG ④	W6
10	10	30	30 ④	34...40	480	KTA9-40H-40A-WG ④	W6
KTA7-45H High Interrupting Capacity							
2	3	5	7-1/2	6.3...10	130	KTA7-45H-10A-WG	R/F
3	5	10	10	10...16	208	KTA7-45H-16A-WG	R/F
5	5	10	15	14.5...20	260	KTA7-45H-20A-WG	R/F
7-1/2	7-1/2	15	20	18...25	325	KTA7-45H-25A-WG	R/F
7-1/2	10	20	30	23...32	416	KTA7-45H-32A-WG	R/F
10	15	30	40 ④	32...45	585	KTA7-45H-45A-WG ④	R/F

Includes:

- Type 4 / 12 enclosure – watertight, dusttight
- KTA9 “Type E” Self-protected Combination Manual Controller ④
- Terminal Adaptor for Type E Applications (Cat.# KT9-40-TE or KT7-45-TE)
- Gray and black Type 4/4X/12; IP66 handle (Cat.# KT9-HTN) ⑤

Modifications (Factory Assembled)

Description	Add Suffix to Cat. Number
KT9 Auxiliaries & Trip Contacts, Front Mount 250V max.	
1 NO Auxiliary	-B
1 NC Auxiliary	-A
1 NO + 1 NC Auxiliary	-C
2 NO Auxiliaries	-D
1 NO SC+OL + 1 NC	-R
1 NO SC+OL + 1 NO	-S
Side Mount 600V max.	
2 NC Auxiliaries	-AS02
2 NO Auxiliaries	-AS20
1 NO + 1 NC Auxiliary	-AS11
Additional KT9 Trip Contacts, Side Mount 600V max.	
1 NO SC+OL+1 NO SC	-R00
1 NO SC+OL+1 NC SC	-R01
1 NC SC+OL+1 NO SC	-R10
Accessories	
Undervoltage Release Module	-UA-*
Shunt Release Module	-AA-*

-UA...AA Coil Codes (*)

AC Coil Code	Voltage Range	
	50 Hz	60 Hz
24V	24V	24V...28V
120V	110V	120V
230V	220...230V	~
260V	~	240...260V
277V	~	277V
400V	380...400V	~
480V	415V	480V

① Horsepower ratings shown in the table above are for reference. The final selection of the controller depends on the actual motor full load current and service factor.

- For motor with service factor less than 1.15. Use motor nameplate full load current times 0.9 and choose the motor starter with the appropriate current range. Example: Motor FLC = 4.2A; S.F. = 1.0. 4.2A x 0.9 = 3.78A. Select catalog number KTA9-32S-4.0A.

- ② KTA9 may be applied to single phase loads if 3 poles of device are wired in series. See footnote 1 for device selection criteria.
- ③ A red and yellow handle may be selected instead of the standard gray and black handle. Change “WG” suffix to “WJ”. Ex: Change KTA9-32S-0.16-WG to KTA9-32S-0.16-WJ.
- ④ Catalog numbers with specific voltages (i.e. @ 575V) shaded in gray are suitable for use as a manual motor starter only because they are not Type E rated. See page F5 for ratings.

KTA9 Explosion Proof Motor Controllers - NEMA Type 7/9

Amp / Horsepower Rating					O/L Relay Ampere Range	Magnetic Res. Current	Catalog Number	Dim Code
Max. Horsepower ①②								
Three Phase								
200V	230V	460V	575V					
KTA9-32S Standard Interrupting Capacity								
~	~	~	~	0.10...0.16	2.2	KTA9-32S-0.16A-EX	EX	
~	~	~	~	0.16...0.25	3.5	KTA9-32S-0.25A-EX	EX	
~	~	~	~	0.25...0.40	5.6	KTA9-32S-0.4A-EX	EX	
~	~	~	~	0.40...0.63	8.8	KTA9-32S-0.63A-EX	EX	
~	~	1/2	1/2	0.63...1.0	14	KTA9-32S-1.0A-EX	EX	
~	~	3/4	~	1.0...1.6	22	KTA9-32S-1.6A-EX	EX	
1/2	1/2	1	1-1/2	1.6...2.5	35	KTA9-32S-2.5A-EX	EX	
3/4	3/4	2	3	2.5...4.0	52	KTA9-32S-4.0A-EX	EX	
1	1-1/2	3	5	4.0...6.3	88	KTA9-32S-6.3A-EX	EX	
2	2	5	7-1/2	6.3...10	140	KTA9-32S-10A-EX	EX	
3	5	10	10	10...16	224	KTA9-32S-16A-EX	EX	
5	5	10	15	14.5...20	280	KTA9-32S-20A-EX	EX	
5	7-1/2	15	20	18...25	330	KTA9-32S-25A-EX	EX	
7-1/2	10	20	25	24...29	406	KTA9-32S-29A-EX	EX	
7-1/2	10	20	30	27...32	448	KTA9-32S-32A-EX	EX	

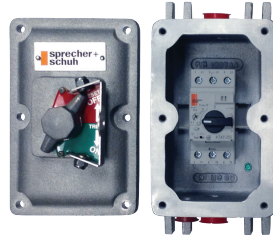

Includes:

- Class I, Div 1, 2, Group C, D
Class II, Div 1, 2, Group E, F & G enclosure
Class III
NEMA Type 7/9
- KTA9 "Type E" Self-protected Combination Manual Motor Controller
- Terminal Adaptor for Type E Applications (Cat.# KT9-40-TE)

Modifications (Factory Assembled)

Description	Add Suffix to Cat. Number
KT9 Auxiliaries & Trip Contacts, Front Mount 250V max. 1 NO Auxiliary 1 NC Auxiliary 1 NO + 1 NC Auxiliary 2 NO Auxiliaries 1 NO SC+OL + 1 NC 1 NO SC+OL + 1 NO	-B -A -C -D -R -S
Side Mount 600V max. 2 NC Auxiliaries 2 NO Auxiliaries 1 NO + 1 NC Auxiliary	-AS02 -AS20 -AS11
Additional KT9 Trip Contacts, Side Mount 600V max. 1 NO SC+OL+1 NO SC 1 NO SC+OL+1 NC SC 1 NC SC+OL+1 NO SC	-R00 -R01 -R10
Accessories Undervoltage Release Module Shunt Release Module	-UA-* -AA-*
Enclosure Modifications Breather/Drain	-BD

① Horsepower ratings shown in the table above are for reference. The final selection of the controller depends on the actual motor full load current and service factor.

- For motor with service factor less than 1.15. Use motor nameplate full load current times 0.9 and choose the motor starter with the appropriate current range. Example: Motor FLC = 4.2A; S.F. = 1.0. 4.2A x 0.9 = 3.78A. Select catalog number KTA9-32S-0.40A.

- ② KTA9 may be applied to single phase loads if 3 poles of device are wired in series. See footnote 1 for device selection criteria.
- ③ Catalog numbers with specific voltages (i.e. @ 575V) shaded in gray are suitable for use as a manual motor starter only because they are not Type E rated. See page F5 for ratings.
- ④ -UA* and -AA* options not possible in the -EX Enclosure.

F Enclosed Motor Circuit Controllers

KTA9 Explosion Proof Motor Controllers – NEMA Type 4/7/9 with Gasket

Amp / Horsepower Rating				O/L Relay Ampere Range	Magnetic Res. Current	Catalog Number ③	Dim Code
Max. Horsepower ①②							
Three Phase							
200V	230V	460V	575V				
KTA9-32S Standard Interrupting Capacity							
~	~	~	~	0.10...0.16	2.2	KTA9-32S-0.16A-EY	EY
~	~	~	~	0.16...0.25	3.5	KTA9-32S-0.25A-EY	EY
~	~	~	~	0.25...0.40	5.6	KTA9-32S-0.40A-EY	EY
~	~	~	~	0.40...0.63	8.8	KTA9-32S-0.63A-EY	EY
~	~	1/2	1/2	0.63...1.0	14	KTA9-32S-1.0A-EY	EY
~	~	3/4	~	1.0...1.6	22	KTA9-32S-1.6A-EY	EY
1/2	1/2	1	1-1/2	1.6...2.5	35	KTA9-32S-2.5A-EY	EY
3/4	3/4	2	3	2.5...4.0	52	KTA9-32S-4.0A-EY	EY
1	1-1/2	3	5	4.0...6.3	88	KTA9-32S-6.3A-EY	EY
2	2	5	7-1/2	6.3...10	140	KTA9-32S-10A-EY	EY
3	5	10	10	10...16	224	KTA9-32S-16A-EY	EY
5	5	10	15	14.5...20	280	KTA9-32S-20A-EY	EY
5	7-1/2	15	20	18...25	330	KTA9-32S-25A-EY	EY
7-1/2	10	20	25	24...29	406	KTA9-32S-29A-EY	EY
7-1/2	10	20	30	27...32	448	KTA9-32S-32A-EY	EY
KTA9-40H High Interrupting Capacity							
~	~	~	~	0.40...0.63	8.8	KTA9-40H-0.63A-EY	EY
~	~	1/2	1/2	0.63...1.0	14	KTA9-40H-1.0A-EY	EY
~	~	3/4	~	1.0...1.6	22	KTA9-40H-1.6A-EY	EY
1/2	1/2	1	1-1/2	1.6...2.5	33	KTA9-40H-2.5A-EY	EY
3/4	3/4	2	3	2.5...4.0	52	KTA9-40H-4.0A-EY	EY
1	1-1/2	3	5	4.0...6.3	82	KTA9-40H-6.3A-EY	EY
2	2	5	7-1/2	6.3...10	130	KTA9-40H-10A-EY	EY
3	5	10	10	10...16	208	KTA9-40H-16A-EY	EY
5	5	10	15	14.5...20	260	KTA9-40H-20A-EY	EY
5	7-1/2	15	20	18...25	325	KTA9-40H-25A-EY	EY
7-1/2	10	20	25	24...29	406	KTA9-40H-29A-EY	EY
7-1/2	10	20	30	27...32	448	KTA9-40H-32A-EY	EY
10	10	25	30	30...36	432	KTA9-40H-36A-EY	EY
10	10	30	30	34...40	480	KTA9-40H-40A-EY	EY
KTA7-45H High Interrupting Capacity							
2	3	5	7-1/2	6.3...10	130	KTA7-45H-10A-EZ	EZ
3	5	10	10	10...16	208	KTA7-45H-16A-EZ	EZ
5	5	10	15	14.5...20	260	KTA7-45H-20A-EZ	EZ
7-1/2	7-1/2	15	20	18...25	325	KTA7-45H-25A-EZ	EZ
7-1/2	10	20	30	23...32	416	KTA7-45H-32A-EZ	EZ
10	15	30	40	32...45	585	KTA7-45H-45A-EZ	EZ

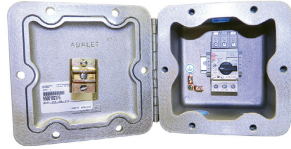

EY Enclosure shown

Includes:

- Class I, Div 1, 2, Group C, D
Class II, Div 1, 2, Group E, F & G enclosure
Class III
- NEMA Type 4/7/9
- KTA9 "Type E" Self-protected Combination Manual Motor Controller ③
- Terminal Adaptor for Type E Applications
(Cat.# KT9-40-TE or KT7-45-TE)

Modifications (Factory Assembled)

Description	Add Suffix to Cat. Number
KT9 Auxiliaries & Trip Contacts, Front Mount 250V max. 1 NO Auxiliary 1 NC Auxiliary 1 NO + 1 NC Auxiliary 2 NO Auxiliaries 1 NO SC+OL + 1 NC 1 NO SC+OL + 1 NO	-B -A -C -D -R -S
Side Mount 600V max. 2 NC Auxiliaries 2 NO Auxiliaries 1 NO + 1 NC Auxiliary	-AS02 -AS20 -AS11
Additional KT9 Trip Contacts, Side Mount 600V max. 1 NO SC+OL+1 NO SC 1 NO SC+OL+1 NC SC 1 NC SC+OL+1 NO SC	-R00 -R01 -R10
Accessories Undervoltage Release Module Shunt Release Module	-UA-* -AA-*
Enclosure Modifications Breather/Drain	-BD

-UA..-AA Coil Codes (*)

AC Coil Code	Voltage Range	
	50 Hz	60 Hz
24V	24V	24V...28V
120V	110V	120V
230V	220...230V	~
260V	~	240...260V
277V	~	277V
400V	380...400V	~
480V	415V	480V

① Horsepower ratings shown in the table above are for reference. *The final selection of the controller depends on the actual motor full load current and service factor.*

• For motor with service factor less than 1.15. Use motor nameplate full load current times 0.9 and choose the motor starter with the appropriate current range. Example: Motor FLC = 4.2A; S.F. = 1.0. 4.2A x 0.9 = 3.78A. Select catalog number KTA9-32S-4.0A.

② KTA9 may be applied to single phase loads if 3 poles of device are wired in series. See footnote ① for device selection criteria.

③ Catalog numbers with specific voltages (i.e. @ 575V) shaded in gray are suitable for use as a manual motor starter only because they are not Type E rated. See page F5 for ratings.

Enclosed KTU9 Circuit Breaker - Type 4 / 4X / 12

Amp / Interrupt Rating					Non-metallic, Type 4 / 4X / 12 Enclosure	
① Fixed Thermal Current Rating [A]	Magnetic Trip [A]	Interrupting Rating (60Hz) [KA]			Catalog Number	Dimension Code
		240V	480Y /277V	600Y /347V		
KTU9-D — High Interrupting Capacity – 2-Pole						
0.5	15...20xI _n	100	100	50	KTU9-40H-2D-0.5-VG	Q6 ①
1.0	15...20xI _n	100	100	50	KTU9-40H-2D-1-VG	
2.0	15...20xI _n	100	100	50	KTU9-40H-2D-2-VG	
3.0	15...20xI _n	100	100	50	KTU9-40H-2D-3-VG	
4.0	15...20xI _n	100	100	50	KTU9-40H-2D-4-VG	
5.0	15...20xI _n	100	100	50	KTU9-40H-2D-5-VG	
6.0	15...20xI _n	100	100	50	KTU9-40H-2D-6-VG	
8.0	15...20xI _n	100	100	50	KTU9-40H-2D-8-VG	
10.0	15...20xI _n	100	100	50	KTU9-40H-2D-10-VG	
12.0	15...20xI _n	65	65	25	KTU9-40H-2D-12-VG	
15.0	15...20xI _n	65	65	25	KTU9-40H-2D-15-VG	
20.0	15...20xI _n	65	65	~	KTU9-40H-2D-20-VG	
25.0	15...20xI _n	65	65	~	KTU9-40H-2D-25-VG	
30.0	15...20xI _n	65	65	~	KTU9-40H-2D-30-VG	
35.0	14 x I _n	65	65	~	KTU9-40H-2D-35-VG	
40.0	12 x I _n	65	65	~	KTU9-40H-2D-40-VG	
KTU9-D — High Interrupting Capacity – 3-Pole						
0.5	15...20xI _n	100	100	50	KTU9-40H-3D-0.5-VG	Q6 ①
1.0	15...20xI _n	100	100	50	KTU9-40H-3D-1-VG	
2.0	15...20xI _n	100	100	50	KTU9-40H-3D-2-VG	
3.0	15...20xI _n	100	100	50	KTU9-40H-3D-3-VG	
4.0	15...20xI _n	100	100	50	KTU9-40H-3D-4-VG	
5.0	15...20xI _n	100	100	50	KTU9-40H-3D-5-VG	
6.0	15...20xI _n	100	100	50	KTU9-40H-3D-6-VG	
8.0	15...20xI _n	100	100	50	KTU9-40H-3D-8-VG	
10.0	15...20xI _n	100	100	50	KTU9-40H-3D-10-VG	
12.0	15...20xI _n	65	65	25	KTU9-40H-3D-12-VG	
15.0	15...20xI _n	65	65	25	KTU9-40H-3D-15-VG	
20.0	15...20xI _n	65	65	~	KTU9-40H-3D-20-VG	
25.0	15...20xI _n	65	65	~	KTU9-40H-3D-25-VG	
30.0	15...20xI _n	65	65	~	KTU9-40H-3D-30-VG	
35.0	14 x I _n	65	65	~	KTU9-40H-3D-35-VG	
40.0	12 x I _n	65	65	~	KTU9-40H-3D-40-VG	



Includes:

- Type 4 / 4X / 12 enclosure – watertight, dusttight, corrosion resistant
- KTU9 UL489 Molded Case Circuit Breaker
- Black Type 4/4X/12; IP66 handle (Cat.# KT9-HTN Series E) ②

Modifications (Factory Assembled) ③

KT9 Auxiliaries & Trip Contacts - Front Mount 250V max.	Add Suf- fix to Cat. Number
1 NO Auxiliary	-B
1 NC Auxiliary	-A
1 NO + 1 NC Auxiliary	-C
2 NO Auxiliaries	-D
1 NO SC+OL + 1 NC Auxiliary	-R
1 NO SC+OL + 1 NO Auxiliary	-S

① KTU9 is 80% rated in this enclosure.
 ② A red and yellow handle may be selected instead of the standard black handle. Change "VG" suffix to "VJ". Ex: Change KTU9-40H-2D-0.16-VG to KTU9-40H-2D-0.16-VJ.
 ③ Load Terminal Cover KT9-PEFC is included with any factory modifications.

Enclosed KTU9 Circuit Breaker - Type 12

Fixed Thermal Current Rating [A]		Magnetic Trip [A]	Interrupting Rating (60Hz) [KA]			Catalog Number	Dim Code
			240V	480Y /277V	600Y /347V		
<div style="display: flex; justify-content: space-between;"> <div style="text-align: center;"> <p>Amp / Interrupt Rating</p> </div> <div style="text-align: center;"> <p>Painted Steel, Type 12 Enclosure</p>  </div> </div>							
KTU9-40H-2D — High Interrupting Capacity – 2-Pole							
0.5	15...20xI _n	100	100	50	KTU9-40H-2D-0.5-DG	L ①	
1.0	15...20xI _n	100	100	50	KTU9-40H-2D-1-DG		
2.0	15...20xI _n	100	100	50	KTU9-40H-2D-2-DG		
3.0	15...20xI _n	100	100	50	KTU9-40H-2D-3-DG		
4.0	15...20xI _n	100	100	50	KTU9-40H-2D-4-DG		
5.0	15...20xI _n	100	100	50	KTU9-40H-2D-5-DG		
6.0	15...20xI _n	100	100	50	KTU9-40H-2D-6-DG		
8.0	15...20xI _n	100	100	50	KTU9-40H-2D-8-DG		
10.0	15...20xI _n	100	100	50	KTU9-40H-2D-10-DG		
12.0	15...20xI _n	65	65	25	KTU9-40H-2D-12-DG		
15.0	15...20xI _n	65	65	25	KTU9-40H-2D-15-DG		
20.0	15...20xI _n	65	65	~	KTU9-40H-2D-20-DG		
25.0	15...20xI _n	65	65	~	KTU9-40H-2D-25-DG		
30.0	15...20xI _n	65	65	~	KTU9-40H-2D-30-DG		
35.0	14 x I _n	65	65	~	KTU9-40H-2D-35-DG		
40.0	12 x I _n	65	65	~	KTU9-40H-2D-40-DG		
KTU9-40H-3D — High Interrupting Capacity – 3-Pole							
0.5	15...20xI _n	100	100	50	KTU9-40H-3D-0.5-DG	L ①	
1.0	15...20xI _n	100	100	50	KTU9-40H-3D-1-DG		
2.0	15...20xI _n	100	100	50	KTU9-40H-3D-2-DG		
3.0	15...20xI _n	100	100	50	KTU9-40H-3D-3-DG		
4.0	15...20xI _n	100	100	50	KTU9-40H-3D-4-DG		
5.0	15...20xI _n	100	100	50	KTU9-40H-3D-5-DG		
6.0	15...20xI _n	100	100	50	KTU9-40H-3D-6-DG		
8.0	15...20xI _n	100	100	50	KTU9-40H-3D-8-DG		
10.0	15...20xI _n	100	100	50	KTU9-40H-3D-10-DG		
12.0	15...20xI _n	65	65	25	KTU9-40H-3D-12-DG		
15.0	15...20xI _n	65	65	25	KTU9-40H-3D-15-DG		
20.0	15...20xI _n	65	65	~	KTU9-40H-3D-20-DG		
25.0	15...20xI _n	65	65	~	KTU9-40H-3D-25-DG		
30.0	15...20xI _n	65	65	~	KTU9-40H-3D-30-DG		
35.0	14 x I _n	65	65	~	KTU9-40H-3D-35-DG		
40.0	12 x I _n	65	65	~	KTU9-40H-3D-40-DG		



Includes:

- Type 12 enclosure – dusttight
- KTU9 UL489 Molded Case Circuit Breaker
- Black Type 4/4X/12; IP66 handle (Cat.# KT9-HTN) ②

Modifications (Factory Assembled) ③

KT9 Auxiliaries & Trip Contacts - Front Mount 250V max.	Add Suffix to Cat. Number
1 NO Auxiliary	-B
1 NC Auxiliary	-A
1 NO + 1 NC Auxiliary	-C
2 NO Auxiliaries	-D
1 NO SC+OL + 1 NC Auxiliary	-R
1 NO SC+OL + 1 NO Auxiliary	-S

① KTU9 is 80% rated in this enclosure.

② A red and yellow handle may be selected instead of the standard black handle. Change “DG” suffix to “DJ”. Ex: Change KTU9-40H-2D-0.16-DG to KTU9-D-2D-0.16-DJ.

③ Load Terminal Cover KT9-PEFC is included with any factory modifications.

Enclosed KTU9 Circuit Breaker - Type 4 / 12

Amp / Interrupt Rating					Painted Steel, Type 4 / 12 Enclosure	
Fixed Thermal Current Rating [A]	Magnetic Trip [A]	Interrupting Rating (60Hz) [KA]			Catalog Number	Dimension Code
		240V	480Y /277V	600Y /347V		
KTU9-40H-2D — High Interrupting Capacity – 2-Pole						
0.5	15...20xI _n	100	100	50	KTU9-40H-2D-0.5-WG	W6 ①
1.0	15...20xI _n	100	100	50	KTU9-40H-2D-1-WG	
2.0	15...20xI _n	100	100	50	KTU9-40H-2D-2-WG	
3.0	15...20xI _n	100	100	50	KTU9-40H-2D-3-WG	
4.0	15...20xI _n	100	100	50	KTU9-40H-2D-4-WG	
5.0	15...20xI _n	100	100	50	KTU9-40H-2D-5-WG	
6.0	15...20xI _n	100	100	50	KTU9-40H-2D-6-WG	
8.0	15...20xI _n	100	100	50	KTU9-40H-2D-8-WG	
10.0	15...20xI _n	100	100	50	KTU9-40H-2D-10-WG	
12.0	15...20xI _n	65	65	25	KTU9-40H-2D-12-WG	
15.0	15...20xI _n	65	65	25	KTU9-40H-2D-15-WG	
20.0	15...20xI _n	65	65	~	KTU9-40H-2D-20-WG	
25.0	15...20xI _n	65	65	~	KTU9-40H-2D-25-WG	
30.0	15...20xI _n	65	65	~	KTU9-40H-2D-30-WG	
35.0	14 x I _n	65	65	~	KTU9-40H-2D-35-WG	
40.0	12 x I _n	65	65	~	KTU9-40H-2D-40-WG	
KTU9-40H-3D — High Interrupting Capacity – 3-Pole						
0.5	15...20xI _n	100	100	50	KTU9-40H-3D-0.5-WG	W6 ①
1.0	15...20xI _n	100	100	50	KTU9-40H-3D-1-WG	
2.0	15...20xI _n	100	100	50	KTU9-40H-3D-2-WG	
3.0	15...20xI _n	100	100	50	KTU9-40H-3D-3-WG	
4.0	15...20xI _n	100	100	50	KTU9-40H-3D-4-WG	
5.0	15...20xI _n	100	100	50	KTU9-40H-3D-5-WG	
6.0	15...20xI _n	100	100	50	KTU9-40H-3D-6-WG	
8.0	15...20xI _n	100	100	50	KTU9-40H-3D-8-WG	
10.0	15...20xI _n	100	100	50	KTU9-40H-3D-10-WG	
12.0	15...20xI _n	65	65	25	KTU9-40H-3D-12-WG	
15.0	15...20xI _n	65	65	25	KTU9-40H-3D-15-WG	
20.0	15...20xI _n	65	65	~	KTU9-40H-3D-20-WG	
25.0	15...20xI _n	65	65	~	KTU9-40H-3D-25-WG	
30.0	15...20xI _n	65	65	~	KTU9-40H-3D-30-WG	
35.0	14 x I _n	65	65	~	KTU9-40H-3D-35-WG	
40.0	12 x I _n	65	65	~	KTU9-40H-3D-40-WG	



Includes:

- Type 4/12 enclosure – watertight, dusttight
- KTU9 UL489 Molded Case Circuit Breaker
- Black Type 4/4X/12; IP66 handle (Cat.# KT9-HTN) ②

Modifications (Factory Assembled) ③

KT9 Auxiliaries & Trip Contacts - Front Mount 250V max.	Add Suffix to Cat. Number
1 NO Auxiliary	-B
1 NC Auxiliary	-A
1 NO + 1 NC Auxiliary	-C
2 NO Auxiliaries	-D
1 NO SC+OL + 1 NC Auxiliary	-R
1 NO SC+OL + 1 NO Auxiliary	-S

① KTU9 up to 15 Amp is 100% rated in this enclosure. KTU9 20...30 Amp is 80% rated.
 ② A red and yellow handle may be selected instead of the standard black handle. Change "WG" suffix to "WJ". Ex: Change KTU9-40H-2D-0.16-WG to KTU9-40H-2D-0.16-WJ.
 ③ Load Terminal Cover KT9-PEFC is included with any factory modifications.

Enclosed Non-Reversing Combination Controller, AC Operation - Type 1/12K/IP66 ⑥⑦

Amp / Horsepower Rating				Non-Metallic Type 1/12K/IP66 Enclosure (KS7-COC4R)			
				O/L Relay Ampere Range	Magnetic Response Current	Catalog Number ④③③③	Dim Code
Three Phase							
200V	230V	460V	575V				
KTA9-32S Standard Interrupting Capacity							
~	~	~	~	0.10...0.16	2.2	CX7-9-10-*-AS0.16A-A10-PG▼	Q4
~	~	~	~	0.16...0.25	3.5	CX7-9-10-*-AS0.25A-A10-PG▼	Q4
~	~	~	~	0.25...0.40	5.6	CX7-9-10-*-AS0.4A-A10-PG▼	Q4
~	~	~	~	0.40...0.63	8.8	CX7-9-10-*-AS0.63A-A10-PG▼	Q4
~	~	1/2	1/2	0.63...1.0	14	CX7-9-10-*-AS1.0A-A10-PG▼	Q4
~	~	3/4	~	1.0...1.6	22	CX7-9-10-*-AS1.6A-A10-PG▼	Q4
1/2	1/2	1	1-1/2	1.6...2.5	35	CX7-9-10-*-AS2.5A-A10-PG▼	Q4
3/4	3/4	2	3	2.5...4.0	52	CX7-9-10-*-AS4.0A-A10-PG▼	Q4
1	1-1/2	3	~	4.0...6.3	88	CX7-9-10-*-AS6.3A-A10-PG▼	Q4
2	2	5	~	6.3...10	140	CX7-12-10-*-AS10A-A10-PG▼	Q4
3	5	10	~	10...16	224	CX7-16-10-*-AS16A-A10-PG▼	Q4
KTA9-40H High Interrupting Capacity							
~	~	~	~	0.40...0.63	8.8	CX7-9-10-*-AH0.63A-A10-PG▼	Q4
~	~	1/2	1/2	0.63...1.0	14	CX7-9-10-*-AH1.0A-A10-PG▼	Q4
~	~	3/4	~	1.0...1.6	22	CX7-9-10-*-AH1.6A-A10-PG▼	Q4
1/2	1/2	1	1-1/2	1.6...2.5	33	CX7-9-10-*-AH2.5A-A10-PG▼	Q4
3/4	3/4	2	3	2.5...4.0	52	CX7-9-10-*-AH4.0A-A10-PG▼	Q4
1	1-1/2	3	5	4.0...6.3	82	CX7-9-10-*-AH6.3A-A10-PG▼	Q4
2	2	5	7-1/2	6.3...10	130	CX7-12-10-*-AH10A-A10-PG▼	Q4
3	5	10	10	10...16	208	CX7-16-10-*-AH16A-A10-PG▼	Q4
5	5	10	~	14.5...20	260	CX7-23-10-*-AH20A-A10-PG▼	Q4
5	7-1/2	15	~	18...25	325	CX7-23-10-*-AH25A-A10-PG▼	Q4

Includes:

- Type 1/12K Non-metallic enclosure (KS7-COC4R)
- KTA9 "Type E/F" Self-protected Combination Motor Controller with 1 NO front mount Auxiliary Contact (Cat #: KT9-PE1-10)
- Terminal Adaptor for Type E Applications (Cat.# KT9-40-TE)
- CA7 contactor (for remote operation), AC coil
- Gray and black Type 1/12K; IP66 handle (KT9-SHB + KT9-KN) ③
- Power wiring
- Factory installed Pilot device option ⑥

*Replace ▼ with option code.
See page F1.71 for
factory installed modifications*

Contactor

AC Coil Codes (*) ④

AC Coil Code	Voltage Range	
	50 Hz	60 Hz
024Z	24V	24V
0120	110V	120V
220W	200-220V	208-240V
0415	400-415V	~
0480 ⑥	440V	480V
0600 ⑥	550V	600V

KWIKstarter coils are wired standard from the factory to terminals "L1" and "L2" (for line voltage control). This means the coil voltage must match the line voltage. When a coil is specified for 120V or less, it will be wired for a separate control source (not wired to L1 and L2).

- ① Horsepower ratings shown in the table above are for reference. The final selection of the controller depends on the actual motor full load current and service factor. For motor with service factor less than 1.15. Use motor nameplate full load current times 0.9 and choose the motor starter with the appropriate current range. Example: Motor FLC = 4.2A; S.F. = 1.0. 4.2A x 0.9 = 3.78A. Select catalog number KTA9-32S-4.0A.
- ② Magnetic trip is fixed at 14x the maximum value of the current adjustment range.
- ③ CX7 may be applied to single phase loads. Contact factory for these specifications.
- ④ Other voltages available, see Section A in this catalog.
- ⑤ KAIC Assembly Rating Index. See pages F73-F76 for Application Rating Guide.
- ⑥ One Pilot Device option must be selected. Plastic Bezel is standard. Pilot Device options include D7-BX Base Mounted contact blocks. Pilot Light option must match coil voltage 24V AC or DC, 120V AC or 240V AC only. See Section H for more information.

- ⑦ CPT not possible with KS7-COC4R. Refer to page F1.86 for wiring diagram and F1.87 for dimensional information.
- ⑧ A red and yellow handle may be selected instead of the standard gray and black handle. Change "PG" suffix to "PJ". Ex: Change CX7-9-10-*-AS0.16A-A10-PG▼ to CX7-9-10-*-AS0.16A-A10-PJ▼.
- ⑨ Catalog number (-A10) includes front-mounted auxiliary KT9-PE1-10 with 250 VAC maximum control circuit matching line voltage, or provided from separate source, used to de-energize contactor coil under fault condition (auxiliary not available for customer use). For control circuits greater than 300 VAC, which is common with line voltage, the auxiliary will not be wired into the control circuit since the contactor coil will be de-energized when KTA9 is tripped due to overload or short circuit; therefore, the KT9-PE1-10 auxiliary is available for customer use.

F Enclosed Motor Circuit Controllers

Enclosed Non-Reversing Combination Controller, Electronic DC Operation - Type 1/12K/IP66 ④⑥⑦

Amp / Horsepower Rating					O/L Relay Ampere Range		Magnetic Response Current	Non-Metallic Type 1/12K/IP66 Enclosure (KS7-COC4R)		Dim Code
								Catalog Number ④⑥⑧		
Max. Horsepower ①②③				Three Phase	O/L Relay Ampere Range	Magnetic Response Current	Non-Metallic Type 1/12K/IP66 Enclosure (KS7-COC4R)		Dim Code	
200V	230V	460V	575V				Catalog Number ④⑥⑧			
KTA9-32S Standard Interrupting Capacity										
~	~	~	~	~	0.10...0.16	2.2	CX7-9E-10- * -AS0.16A-A10-PG▼	Q4		
~	~	~	~	~	0.16...0.25	3.5	CX7-9E-10- * -AS0.25A-A10-PG▼	Q4		
~	~	~	~	~	0.25...0.40	5.6	CX7-9E-10- * -AS0.4A-A10-PG▼	Q4		
~	~	~	~	~	0.40...0.63	8.8	CX7-9E-10- * -AS0.63A-A10-PG▼	Q4		
~	~	1/2	1/2	~	0.63...1.0	14	CX7-9E-10- * -AS1.0A-A10-PG▼	Q4		
~	~	3/4	~	~	1.0...1.6	22	CX7-9E-10- * -AS1.6A-A10-PG▼	Q4		
1/2	1/2	1	1-1/2	~	1.6...2.5	35	CX7-9E-10- * -AS2.5A-A10-PG▼	Q4		
3/4	3/4	2	3	~	2.5...4.0	52	CX7-9E-10- * -AS4.0A-A10-PG▼	Q4		
1	1-1/2	3	~	~	4.0...6.3	88	CX7-9E-10- * -AS6.3A-A10-PG▼	Q4		
2	2	5	~	~	6.3...10	140	CX7-12E-10- * -AS10A-A10-PG▼	Q4		
3	5	10	~	~	10...16	224	CX7-16E-10- * -AS16A-A10-PG▼	Q4		
KTA9-40H High Interrupting Capacity										
~	~	~	~	~	0.40...0.63	8.8	CX7-9E-10- * -AH0.63A-A10-PG▼	Q4		
~	~	1/2	1/2	~	0.63...1.0	14	CX7-9E-10- * -AH1.0A-A10-PG▼	Q4		
~	~	3/4	~	~	1.0...1.6	22	CX7-9E-10- * -AH1.6A-A10-PG▼	Q4		
1/2	1/2	1	1-1/2	~	1.6...2.5	33	CX7-9E-10- * -AH2.5A-A10-PG▼	Q4		
3/4	3/4	2	3	~	2.5...4.0	52	CX7-9E-10- * -AH4.0A-A10-PG▼	Q4		
1	1-1/2	3	5	~	4.0...6.3	82	CX7-9E-10- * -AH6.3A-A10-PG▼	Q4		
2	2	5	7-1/2	~	6.3...10	130	CX7-12E-10- * -AH10A-A10-PG▼	Q4		
3	5	10	10	~	10...16	208	CX7-16E-10- * -AH16A-A10-PG▼	Q4		
5	5	10	~	~	14.5...20	260	CX7-23E-10- * -AH20A-A10-PG▼	Q4		
5	7-1/2	15	~	~	18...25	325	CX7-23E-10- * -AH25A-A10-PG▼	Q4		



Includes:

- Type 1/12K Non-metallic enclosure (KS7-COC4R)
- KTA9 "Type E/F" Self-protected Combination Motor Controller with 1 NO front mount Auxiliary Contact (Cat #: KT9-PE1-10)
- Terminal Adaptor for Type E Applications (Cat.# KT9-40-TE)
- CA7 contactors (for remote operation), with Electronic DC Coil
- Gray and black Type 1/12K; IP66 handle (KT9-SHB) + KT9-KN ③
- Power wiring
- Factory installed Pilot device option ⑥

*Replace ▼ with option code.
See page F1.71 for
factory installed modifications*

Contactors Electronic DC Coil Codes (*) ④

DC Coil Codes	Voltage
012E	12V
024E	24V
036E	36-48V
048E	48-72V
110E	110-125V
220E	220-250V

KWIKstarter coils are wired standard from the factory to terminals "L1" and "L2" (for line voltage control). This means the coil voltage must match the line voltage. When a coil is specified for 120V or less, it will be wired for a separate control source (not wired to L1 and L2).

- ① Horsepower ratings shown in the table above are for reference. The final selection of the controller depends on the actual motor full load current and service factor. For motor with service factor less than 1.15. Use motor nameplate full load current times 0.9 and choose the motor starter with the appropriate current range. Example: Motor FLC = 4.2A; S.F. = 1.0. 4.2A x 0.9 = 3.78A. Select catalog number KTA9-32S-4.0A.
- ② Magnetic trip is fixed at 14x the maximum value of the current adjustment range.
- ③ CX7 may be applied to single phase loads. Contact factory for these specifications.
- ④ CX7-9E...23E with electronic coils are not interchangeable with non-electronic DC or AC coils.
- ⑤ KAIC Assembly Rating Index. See pages F73-F76 for Application Rating Guide.

- ⑥ One Pilot Device option must be selected. Plastic Bezel is standard. Pilot Device options include D7-BX_ Base Mounted contact blocks. Pilot Light option must match coil voltage 24V AC or DC, 120V AC or 240V AC only. See Section H for more information.
- ⑦ CPT not possible with KS7-COC4R. Refer to page F1.86 for wiring diagram and F1.87 for dimensional information.
- ⑧ A red and yellow handle may be selected instead of the standard gray and black handle. Change "PG" suffix to "PJ". Ex: Change CX7-9-10-*****-AS0.16A-A10-PG▼ to CX7-9-10-*****-AS0.16A-A10-PJ▼.

F Enclosed Motor Circuit Controllers

Enclosed Non-Reversing Combination Controller with E-Stop, AC Operation - Type 1/12K/IP66 ①⑦③

Amp / Horsepower Rating					Non-Metallic Type 1/12K/IP66 Enclosure (KS7-C0C4R)			Dim Code
Max. Horsepower ②③④				O/L Relay Ampere Range	Magnetic Response Current	Catalog Number ⑤⑦⑨⑩		
Three Phase								
200V	230V	460V	575V					
KTA9-32S Standard Interrupting Capacity								
~	~	~	~	0.10...0.16	2.2	CX7-9-10-*-AS0.16A-A10-PG4U-9	Q4	
~	~	~	~	0.16...0.25	3.5	CX7-9-10-*-AS0.25A-A10-PG4U-9	Q4	
~	~	~	~	0.25...0.40	5.6	CX7-9-10-*-AS0.4A-A10-PG4U-9	Q4	
~	~	~	~	0.40...0.63	8.8	CX7-9-10-*-AS0.63A-A10-PG4U-9	Q4	
~	~	1/2	1/2	0.63...1.0	14	CX7-9-10-*-AS1.0A-A10-PG4U-9	Q4	
~	~	3/4	~	1.0...1.6	22	CX7-9-10-*-AS1.6A-A10-PG4U-9	Q4	
1/2	1/2	1	1-1/2	1.6...2.5	35	CX7-9-10-*-AS2.5A-A10-PG4U-9	Q4	
3/4	3/4	2	3	2.5...4.0	52	CX7-9-10-*-AS4.0A-A10-PG4U-9	Q4	
1	1-1/2	3	~	4.0...6.3	88	CX7-9-10-*-AS6.3A-A10-PG4U-9	Q4	
2	2	5	~	6.3...10	140	CX7-12-10-*-AS10A-A10-PG4U-9	Q4	
3	5	10	~	10...16	224	CX7-16-10-*-AS16A-A10-PG4U-9	Q4	
KTA9-40H High Interrupting Capacity								
~	~	~	~	0.40...0.63	8.8	CX7-9-10-*-AH0.63A-A10-PG4U-9	Q4	
~	~	1/2	1/2	0.63...1.0	14	CX7-9-10-*-AH1.0A-A10-PG4U-9	Q4	
~	~	3/4	~	1.0...1.6	22	CX7-9-10-*-AH1.6A-A10-PG4U-9	Q4	
1/2	1/2	1	1-1/2	1.6...2.5	33	CX7-9-10-*-AH2.5A-A10-PG4U-9	Q4	
3/4	3/4	2	3	2.5...4.0	52	CX7-9-10-*-AH4.0A-A10-PG4U-9	Q4	
1	1-1/2	3	5	4.0...6.3	82	CX7-9-10-*-AH6.3A-A10-PG4U-9	Q4	
2	2	5	7-1/2	6.3...10	130	CX7-12-10-*-AH10A-A10-PG4U-9	Q4	
3	5	10	10	10...16	208	CX7-16-10-*-AH16A-A10-PG4U-9	Q4	
5	5	10	~	14.5...20	260	CX7-23-10-*-AH20A-A10-PG4U-9	Q4	
5	7-1/2	15	~	18...25	325	CX7-23-10-*-AH25A-A10-PG4U-9	Q4	



Includes:

- Type 1/12K Non-metallic enclosure (KS7-C0C4R) ①
- KTA9 “Type E/F” Self-protected Combination Motor Controller with 1 NO front mount Auxiliary Contact (Cat #: KT9-PE1-10)
- Terminal Adaptor for Type E Applications (Cat.# KT9-40-TE)
- CA7 contactor (for remote operation), AC coil
- Multifunction 2-position Push Button and Emergency Stop ⑦
- Gray and black Type 1/12K; IP66 handle (KT9-SHB + KT9-KN) ③
- Power wiring

This is a factory assembly.

Optional factory modifications are not available on this device.

Contactor

AC Coil Codes (*) ⑤

AC Coil Code	Voltage Range	
	50 Hz	60 Hz
024Z	24V	24V
0120	110V	120V
220W	200-220V	208-240V
0415	400-415V	~
0480 ⑥	440V	480V
0600 ⑥	550V	600V

KWIKstarter coils are wired standard from the factory to terminals “L1” and “L2” (for line voltage control). This means the coil voltage must match the line voltage. When a coil is specified for 120V or less, it will be wired for a separate control source (not wired to L1 and L2).

- ① This is a factory assembly. The KS7-C0C4R does not include knock-outs for field assembly of this starter.
- ② Horsepower ratings shown in the table above are for reference. The final selection of the controller depends on the actual motor full load current and service factor. For motor with service factor less than 1.15. Use motor nameplate full load current times 0.9 and choose the motor starter with the appropriate current range. Example: Motor FLC = 4.2A; S.F. = 1.0. 4.2A x 0.9 = 3.78A. Select catalog number KTA9-32S-4.0A.
- ③ Magnetic trip is fixed at 14x the maximum value of the current adjustment range.
- ④ CX7 may be applied to single phase loads. Contact factory for these specifications.
- ⑤ Other voltages available, see Section A in this catalog.
- ⑥ KAIC Assembly Rating Index. See pages F73-F76 for Application Rating Guide.
- ⑦ Uses D7P-U2EFFEPX11 Two-Position Multifunction push button with legend I/O and D7P-MT44PX01 Emergency Stop Push Button.

- ⑧ CPT not possible with KS7-C0C4R. Refer page F1.87 for dimensional information.
- ⑨ A red and yellow handle may be selected instead of the standard gray and black handle. Change “PG” suffix to “PJ”. Ex: CX7-9-10-*-AS0.16A-A10-PG4U-9 becomes CX7-9-10-*-AS0.16A-A10-PJ4U-9.
- ⑩ Catalog number (-A10) includes front-mounted auxiliary KT9-PE1-10 with 250 VAC maximum control circuit matching line voltage, or provided from separate source, used to de-energize contactor coil under fault condition (auxiliary not available for customer use). For control circuits greater than 300 VAC, which is common with line voltage, the auxiliary will not be wired into the control circuit since the contactor coil will be de-energized when KTA9 is tripped due to overload or short circuit; therefore, the KT9-PE1-10 auxiliary is available for customer use.

Enclosed Motor Circuit Controllers

Enclosed Reversing Combination Controller, AC Operation - Type 1/12K/IP66

Amp / Horsepower Rating					Non-Metallic Type 1/12K/IP66 Enclosure (KS7-COC4R)		Dim Code
Max. Horsepower				O/L Relay Ampere Range	Magnetic Response Current	Catalog Number	
Three Phase							
200V	230V	460V	575V				
KTA9-32S Standard Interrupting Capacity							
~	~	~	~	0.10...0.16	2.2	CXU7-9-10- * -AS0.16A-A10-PG▼	Q4
~	~	~	~	0.16...0.25	3.5	CXU7-9-10- * -AS0.25A-A10-PG▼	Q4
~	~	~	~	0.25...0.40	5.6	CXU7-9-10- * -AS0.4A-A10-PG▼	Q4
~	~	~	~	0.40...0.63	8.8	CXU7-9-10- * -AS0.63A-A10-PG▼	Q4
~	~	1/2	1/2	0.63...1.0	14	CXU7-9-10- * -AS1.0A-A10-PG▼	Q4
~	~	3/4	~	1.0...1.6	22	CXU7-9-10- * -AS1.6A-A10-PG▼	Q4
1/2	1/2	1	1-1/2	1.6...2.5	35	CXU7-9-10- * -AS2.5A-A10-PG▼	Q4
3/4	3/4	2	3	2.5...4.0	52	CXU7-9-10- * -AS4.0A-A10-PG▼	Q4
1	1-1/2	3	~	4.0...6.3	88	CXU7-9-10- * -AS6.3A-A10-PG▼	Q4
2	2	5	~	6.3...10	140	CXU7-12-10- * -AS10A-A10-PG▼	Q4
3	5	10	~	10...16	224	CXU7-16-10- * -AS16A-A10-PG▼	Q4
KTA9-40H High Interrupting Capacity							
~	~	~	~	0.40...0.63	8.8	CXU7-9-10- * -AH0.63A-A10-PG▼	Q4
~	~	1/2	1/2	0.63...1.0	14	CXU7-9-10- * -AH1.0A-A10-PG▼	Q4
~	~	3/4	~	1.0...1.6	22	CXU7-9-10- * -AH1.6A-A10-PG▼	Q4
1/2	1/2	1	1-1/2	1.6...2.5	33	CXU7-9-10- * -AH2.5A-A10-PG▼	Q4
3/4	3/4	2	3	2.5...4.0	52	CXU7-9-10- * -AH4.0A-A10-PG▼	Q4
1	1-1/2	3	5	4.0...6.3	82	CXU7-9-10- * -AH6.3A-A10-PG▼	Q4
2	2	5	7-1/2	6.3...10	130	CXU7-12-10- * -AH10A-A10-PG▼	Q4
3	5	10	10	10...16	208	CXU7-16-10- * -AH16A-A10-PG▼	Q4
5	5	10	~	14.5...20	260	CXU7-23-10- * -AH20A-A10-PG▼	Q4
5	7-1/2	15	~	18...25	325	CXU7-23-10- * -AH25A-A10-PG▼	Q4

Non-Metallic Type 1/12K/IP66 Enclosure (KS7-COC4R)



Includes:

- Type 1/12K Non-metallic enclosure (KS7-COC4R)
- KTA9 "Type E/F" Self-protected Combination Motor Controller with 1 NO front mount Auxiliary Contact (Cat #: KT9-PE1-10)
- Terminal Adaptor for Type E Applications (Cat.# KT9-40-TE)
- CA7 contactor (for remote operation), AC coil
- Gray and black Type 1/12K; IP66 handle (KT9-SHB + KT9-KN)
- Power wiring
- Factory installed Pilot device option

Replace ▼ with option code. See page F1.71 for factory installed modifications

Contactor

AC Coil Codes (*)

AC Coil Code	Voltage Range	
	50 Hz	60 Hz
024Z	24V	24V
0120	110V	120V
220W	200-220V	208-240V
0415	400-415V	~
0480	440V	480V
0600	550V	600V

KWIKstarter coils are wired standard from the factory to terminals "L1" and "L2" (for line voltage control). This means the coil voltage must match the line voltage. When a coil is specified for 120V or less, it will be wired for a separate control source (not wired to L1 and L2).

- ❶ Horsepower ratings shown in the table above are for reference. The final selection of the controller depends on the actual motor full load current and service factor. For motor with service factor less than 1.15. Use motor nameplate full load current times 0.9 and choose the motor starter with the appropriate current range. Example: Motor FLC = 4.2A; S.F. = 1.0. 4.2A x 0.9 = 3.78A. Select catalog number KTA9-32S-4.0A.
- ❷ Magnetic trip is fixed at 14x the maximum value of the current adjustment range.
- ❸ CXU7 may be applied to single phase loads. Contact factory for specifications.
- ❹ Other voltages available, see Section A in this catalog.
- ❺ KAIC Assembly Rating Index. See pages F73-F76 for Application Rating Guide.
- ❻ One Pilot Device option must be selected. Plastic Bezel is standard. Pilot Device options include D7-BX Base Mounted contact blocks. Pilot Light option must match coil voltage 24V AC or DC, 120V AC or 240V AC only. See Section H for more information.

- ❼ CPT not possible with KS7-COC4R. Refer to page F1.86 for wiring diagram and F1.87 for dimensional information.
- ❽ A red and yellow handle may be selected instead of the standard gray and black handle. Change "PG" suffix to "PJ". Ex: Change CXU7-9-10-*****-AS0.16A-A10-PG▼ to CXU7-9-10-*****-AS0.16A-A10-PJ▼.
- ❾ Catalog number (-A10) includes front-mounted auxiliary KT9-PE1-10 with 250 VAC maximum control circuit matching line voltage, or provided from separate source, used to de-energize contactor coil under fault condition (auxiliary not available for customer use). For control circuits greater than 300 VAC, which is common with line voltage, the auxiliary will not be wired into the control circuit since the contactor coil will be de-energized when KTA9 is tripped due to overload or short circuit; therefore, the KT9-PE1-10 auxiliary is available for customer use.

Enclosed Reversing Combination Controller, Electronic DC Operation - Type 1/12K/IP66 ④⑥⑦

Amp / Horsepower Rating					Non-Metallic Type 1/12K/IP66 Enclosure (KS7-COC4R)		
Max. Horsepower ①②③				O/L Relay Ampere Range	Magnetic Response Current	Catalog Number ④⑥⑧	Dim Code
Three Phase							
200V	230V	460V	575V				
KTA9-32S Standard Interrupting Capacity							
~	~	~	~	0.10...0.16	2.2	CXU7-9E-22-*AS0.16A-A10-PG▼	Q4
~	~	~	~	0.16...0.25	3.5	CXU7-9E-22-*AS0.25A-A10-PG▼	Q4
~	~	~	~	0.25...0.40	5.6	CXU7-9E-22-*AS0.4A-A10-PG▼	Q4
~	~	~	~	0.40...0.63	8.8	CXU7-9E-22-*AS0.63A-A10-PG▼	Q4
~	~	1/2	1/2	0.63...1.0	14	CXU7-9E-22-*AS1.0A-A10-PG▼	Q4
~	~	3/4	~	1.0...1.6	22	CXU7-9E-22-*AS1.6A-A10-PG▼	Q4
1/2	1/2	1	1-1/2	1.6...2.5	35	CXU7-9E-22-*AS2.5A-A10-PG▼	Q4
3/4	3/4	2	3	2.5...4.0	52	CXU7-9E-22-*AS4.0A-A10-PG▼	Q4
1	1-1/2	3	~	4.0...6.3	88	CXU7-9E-22-*AS6.3A-A10-PG▼	Q4
2	2	5	~	6.3...10	140	CXU7-12E-22-*AS10A-A10-PG▼	Q4
3	5	10	~	10...16	224	CXU7-16E-22-*AS16A-A10-PG▼	Q4
KTA9-40H High Interrupting Capacity							
~	~	~	~	0.40...0.63	8.8	CXU7-9E-22-*AH0.63A-A10-PG▼	Q4
~	~	1/2	1/2	0.63...1.0	14	CXU7-9E-22-*AH1.0A-A10-PG▼	Q4
~	~	3/4	~	1.0...1.6	22	CXU7-9E-22-*AH1.6A-A10-PG▼	Q4
1/2	1/2	1	1-1/2	1.6...2.5	33	CXU7-9E-22-*AH2.5A-A10-PG▼	Q4
3/4	3/4	2	3	2.5...4.0	52	CXU7-9E-22-*AH4.0A-A10-PG▼	Q4
1	1-1/2	3	5	4.0...6.3	82	CXU7-9E-22-*AH6.3A-A10-PG▼	Q4
2	2	5	7-1/2	6.3...10	130	CXU7-12E-22-*AH10A-A10-PG▼	Q4
3	5	10	10	10...16	208	CXU7-16E-22-*AH16A-A10-PG▼	Q4
5	5	10	~	14.5...20	260	CXU7-23E-22-*AH20A-A10-PG▼	Q4
5	7-1/2	15	~	18...25	325	CXU7-23E-22-*AH25A-A10-PG▼	Q4



Includes:

- Type 1/12K Non-metallic enclosure (KS7-COC4R)
- KTA9 "Type E/F" Self-protected Combination Motor Controller with 1 NO front mount Auxiliary Contact (Cat #: KT9-PE1-10)
- Terminal Adaptor for Type E Applications (Cat.# KT9-25-TE)
- CA7 contactors (for remote operation), with Electronic DC coil
- Gray and black Type 1/12K; IP66 handle (KT9-SHB + KT9-KN) ③
- Power wiring
- Factory installed Pilot device option ⑥

*Replace ▼ with option code.
See page F1.71 for
factory installed modifications*

Contactor Electronic DC Coil Codes (*) ④

DC Coil Codes	Voltage
012E	12V
024E	24V
036E	36-48V
048E	48-72V
110E	110-125V
220E	220-250V

KWIKstarter coils are wired standard from the factory to terminals "L1" and "L2" (for line voltage control). This means the coil voltage must match the line voltage. When a coil is specified for 120V or less, it will be wired for a separate control source (not wired to L1 and L2).

- ① Horsepower ratings shown in the table above are for reference. The final selection of the controller depends on the actual motor full load current and service factor. For motor with service factor less than 1.15. Use motor nameplate full load current times 0.9 and choose the motor starter with the appropriate current range. Example: Motor FLC = 4.2A; S.F. = 1.0. 4.2A x 0.9 = 3.78A. Select catalog number KTA9-32S-4.0A.
- ② Magnetic trip is fixed at 14x the maximum value of the current adjustment range.
- ③ CXU7 may be applied to single phase loads. Contact factory for these specifications.
- ④ CXU7-9E...23E with electronic coils are not interchangeable with non-electronic DC or AC coils.
- ⑤ KAIC Assembly Rating Index. See pages F73-F76 for Application Rating Guide.

- ⑥ One Pilot Device option must be selected. Blanks are not available. Plastic Bezel is standard. Pilot Device options include D7-BX Base Mounted contact blocks. Pilot Light option must match coil voltage 24V AC or DC, 120V AC or 240V AC only. See Section H for more information.
- ⑦ CPT not possible with KS7-COC4R. Refer to page F1.86 for wiring diagram and F1.87 for dimensional information.
- ⑧ A red and yellow handle may be selected instead of the standard gray and black handle. Change "PG" suffix to "PJ". Ex: Change CXU7-9-10-*AS0.16A-A10-PG▼ to CXU7-9-10-*AS0.16A-A10-PJ▼.

Enclosed Motor Circuit Controllers

CX7 Non-Reversing Controller Modifications

Pilot Device Options - required	
Select one option only ①②③	Replace ▼ in catalog number with
START-STOP Multi-function	3U
I-O Multi-function	4U
OFF-ON 2-Position Selector switch	6
HAND-OFF-AUTO 3-Position Selector switch	7
Run Pilot Light Green	1G
Run Pilot Light Red	1R
Overload Alarm Pilot Light	1Y
D7-N8 22mm Hole Plug	0
Additional KT9 Auxiliaries & Trip Contacts	
Front Mount 250V maximum	
1 NO + 1 NC Auxiliary	-C
2 NO Auxiliaries	-D
1 NO SC+OL + 1 NC Auxiliary	-T10A01
1 NO SC+OL + 1 NO Auxiliary	-T10A10

CX7 Non-Reversing Controller Additions

Addition	Add to end of catalog number
CA7 Contactor Accessories	
Electronic Interface ④	-JE
Surge Suppressor RC	-RC
Surge Suppressor Varistor	-V
CA7 Auxiliary Contacts ⑤⑥	
1 NO Auxiliary	-\$10
1 NC Auxiliary	-\$01
1 NO + 1 NC Auxiliary	-\$11
2 NO Auxiliaries	-\$20
2 NC Auxiliaries	-\$02
Alternate Aux. Contact Arrangement (CA7 only)	
1 NC in lieu of standard 1 NO	-\$X10
2 NC in lieu of standard 2 NO (on CXU7 only)	-\$X2
Unwired Terminal Blocks Specify quantity (▼)	-▼TB

CXU7 Reversing Controller Modifications

Pilot Device Options - required	
Select one option only ①②③	Replace ▼ in catalog number with
FOR-STOP-REV Multi-function	3U
UP-STOP-DOWN Multi-function	4U
OPEN-STOP-CLOSE Multi-function	5U
FOR-STOP-REV 3-Position Selector switch	6
UP-OFF-DOWN 3-Position Selector switch	7
OPEN-OFF-CLOSE 3-Position Selector switch	8
Overload Alarm Pilot Light	1Y
D7-N8 22mm Hole Plug	0
Additional KT7 Auxiliaries & Trip Contacts	
Front Mount 250V maximum	
1 NO + 1 NC Auxiliary	-C
2 NO Auxiliaries	-D
1 NO SC+OL + 1 NC Auxiliary	-T10A01
1 NO SC+OL + 1 NO Auxiliary	-T10A10

CXU7 Reversing Controller Additions

Addition	Add to end of catalog number
CA7 Contactor Accessories	
Electronic Interface ④	-JE
Surge Suppressor RC	-RC
Surge Suppressor Varistor	-V

- ① KS7-C0C4R only has (1) 22mm hole to accommodate (1) pilot device.
- ② Currently supply D7 multi-function pushbuttons as standard which do not require protective boots to meet Type 4X. See Section H in this catalog for description (all suffix's ending in "U").
- ③ Pilot Lights may be applied with 24VAC/VDC, 120VAC or 240VAC Control Circuit. Pilot Lights with 380 VAC...575VAC require a control circuit



- transformer.
- ④ CRI7E-24 will be used. CRI7E-12 by special order only.
- ⑤ See page A47 for limitations on adding auxiliaries to Electronic DC Coil contactors.
- ⑥ Additional auxiliaries are per contactor. Number of auxiliaries is double for reversing applications.

COMING SOON





CX7 KWIKstarter Enclosures for use with KTA7 Type E Motor Controllers and CA7 Contactors ①③

Component	Description	For Use With		Environmental Approvals	Catalog Number
		Type E Controller	Contactors		
	Enclosure for Combo KWIKstarter ① CX7/CXU7-9...23 CX7/CXU7-9E...23E	KTA7-25S KTA7-25H	CA7-9...23 CA7-9E...23E CAU7-9...23 CAU7-9E...23E	cUL Type 1/12K IEC IP66	KS7-C0C4R

Handle Accessory for CX7/CXU7 KWIKstarters ①

Accessory	Description	For Use With	Color	Catalog Number
	Door Coupling Handle ① • Padlockable • NEMA Type 1/12K and IP66 • Includes handle coupling (shaft) • Requires KT7-KN1 Locking Knob	All KT7s	Gray/Black	T.B.A.
			Red/Yellow	T.B.A.
	Lockable Twist Knob • for use with KT7-SHB	All KT7s	Gray/Black	T.B.A.
	Universal Connector for CX7/CXU7 • Provides electrical interconnection of KTA7 and CA7 (with AC or Electronic DC coil) • Applies to FVNR and FVR versions • Allows for mounting the CA7 on a single DIN rail	All KT7s	Black	T.B.A. ④

CX7 KWIKstarter Pilot Device Kits (for use with KS7-C0C4R Type 1/12K) ①②

Kits	Description	Contact Blocks included		Catalog Number		
		NO	NC			
	Multi-Function Pushbutton kit Non-illuminated START-STOP I-O	1	1	KS7-P3U KS7-P4U	See page C29 for	
	FOR-STOP-REV UP-STOP-DOWN OPEN-STOP-CLOSE	2	1	KS7-P3U-REV KS7-P4U-REV KS7-P5U-REV		
	Selector switch kits Non-illuminated, includes legend plate					
	ON-OFF 2-Position	1	0	KS7-P6		
	HAND-OFF-AUTO 3-Position	2	0	KS7-P7		
	Run Pilot Light or Overload Alarm Pilot Light Plastic operator with diffuser lens in Red, Green or Yellow, with integrated LED power module			Replace ⑤ with color choice R = Red G = Green Y = Yellow		KS7-P1⑤24V ⑥ KS7-P1⑤120V KS7-P1⑤240V
	FOR-OFF-REV 3-Position UP-OFF-DOWN 3-Position OPEN-OFF-CLOSE 3-Position	2	0	KS7-P6-REV KS7-P7-REV KS7-P8-REV		
	Hole Plug used to plug 22.5mm holes.		Gray Plastic	D7-N8		See page H72

① KS7-C0C4R is supplied with the following holes:
• (1) one 22mm hole for a Pilot Device option, select one kit from this page.
• (1) one 22mm hole for KT9-SHB (or SHRY) Disconnect or Reset handle.

② Plastic bezel is standard. Pilot Device Kits include D7-BX_ Base Mounted contact blocks. See Section H for more information.

③ CPT not possible.

④ Standard KT9-32S-PEC23 does not work in CX7/CXU7 Kwikstarters.

⑤ KS7-P1⑤24V can be used with 24VAC or 24VDC.

Enclosed Non-Reversing Combination Controller, AC Operation - Type 4 / 12

Amp / Horsepower Rating					Painted Steel, Type 4 / 12 Enclosure				Dimension Code	
Max. Horsepower ①②				O/L Relay Ampere Range	Magnetic Response Current	Catalog Number ③④				
Three Phase										
200V	230V	460V	575V							
KTA9-32S Standard Interrupting Capacity										
~	~	~	~	0.10...0.16	2.2	CX7-9-10-* AS0.16A-A10-WG	W6			
~	~	~	~	0.16...0.25	3.5	CX7-9-10-* AS0.25A-A10-WG	W6			
~	~	~	~	0.25...0.40	5.6	CX7-9-10-* AS0.4A-A10-WG	W6			
~	~	~	~	0.40...0.63	8.8	CX7-9-10-* AS0.63A-A10-WG	W6			
~	~	1/2	1/2	0.63...1.0	14	CX7-9-10-* AS1.0A-A10-WG	W6			
~	~	3/4	~	1.0...1.6	22	CX7-9-10-* AS1.6A-A10-WG	W6			
1/2	1/2	1	1-1/2	1.6...2.5	35	CX7-9-10-* AS2.5A-A10-WG	W6			
3/4	3/4	2	3	2.5...4.0	52	CX7-9-10-* AS4.0A-A10-WG	W6			
1	1-1/2	3	~	4.0...6.3	88	CX7-9-10-* AS6.3A-A10-WG	W6			
2	2	5	~	6.3...10	140	CX7-12-10-* AS10A-A10-WG	W6			
3	5	10	~	10...16	224	CX7-16-10-* AS16A-A10-WG	W6			
KTA9-40H High Interrupting Capacity										
~	~	~	~	0.40...0.63	8.8	CX7-9-10-* AH0.63A-A10-WG	W6			
~	~	1/2	1/2	0.63...1.0	14	CX7-9-10-* AH1.0A-A10-WG	W6			
~	~	3/4	~	1.0...1.6	22	CX7-9-10-* AH1.6A-A10-WG	W6			
1/2	1/2	1	1-1/2	1.6...2.5	33	CX7-9-10-* AH2.5A-A10-WG	W6			
3/4	3/4	2	3	2.5...4.0	52	CX7-9-10-* AH4.0A-A10-WG	W6			
1	1-1/2	3	5	4.0...6.3	82	CX7-9-10-* AH6.3A-A10-WG	W6			
2	2	5	7-1/2	6.3...10	130	CX7-12-10-* AH10A-A10-WG	W6			
3	5	10	10	10...16	208	CX7-16-10-* AH16A-A10-WG	W6			
5	5	10	~	14.5...20	260	CX7-23-10-* AH20A-A10-WG	W6			
5	7-1/2	15	~	18...25	325	CX7-23-10-* AH25A-A10-WG	W6			
7-1/2	10	20	~	24...29	406	CX7-30-10-* AH29A-A10-WG	W6			
7-1/2	10	25	~	27...32	448	CX7-37-10-* AH32A-A10-WG	W6			
10	10	25	~	30...36	432	CX7-37-10-* AH36A-A10-WG	W6			
10	10	30	~	34...40	480	CX7-43-10-* AH40A-A10-WG	W6			
KTA7-45H High Interrupting Capacity										
3	3	7-1/2	10	6.3...10	130	CX7-30-10-* AH10A-A10-WG	W7			
5	5	10	15	10...16	208	CX7-30-10-* AH16A-A10-WG	W7			
5	7-1/2	15	20	14.5...20	260	CX7-30-10-* AH20A-A10-WG	W7			
7-1/2	10	20	20	18...25	325	CX7-30-10-* AH25A-A10-WG	W7			
7-1/2	10	20	25	23...32	416	CX7-30-10-* AH32A-A10-WG	W7			
10	10	25	~	32...45	585	CX7-37-10-* AH45A-A10-WG	W7			
10	15	30	~	32...45	585	CX7-43-10-* AH45A-A10-WG	W7			

Includes:

- Type 4 / 12 enclosure - watertight, dusttight
- KTA9 "Type E/F" Self-protected Combination Motor Controller with 1 NO front mount Auxiliary Contact (Cat #: KT9-PE1-10)
- Terminal Adaptor for Type E Applications (Cat.# KT9-40-TE or KT7-45-TE)
- CA7 contactor (for remote operation), AC coil
- Power wiring
- Gray and black Type 4/4X/12; IP66 handle (Cat.# KT9-HTN) ③
- Pilot device shown is factory installed option

See page F1.77 for factory installed modifications

Contactor AC Coil Codes (*) ④

AC Coil Code	Voltage Range	
	50 Hz	60 Hz
024Z	24V	24V
0120	110V	120V
220W	200-220V	208-240V
0415	400-415V	~
0480 ⑥	440V	480V
0600 ⑥	550V	600V

① Horsepower ratings shown in the table above are for reference. The final selection of the controller depends on the actual motor full load current and service factor.

- For motor with service factor less than 1.15. Use motor nameplate full load current times 0.9 and choose the motor starter with the appropriate current range. Example: Motor FLC = 4.2A; S.F. = 1.0. 4.2A x 0.9 = 3.78A. Select catalog number KTA9-32S-4.0A.
- ② CX7 may be applied to single phase loads. See footnote 1 for device selection criteria. To order single phase unit, change "CX7" in catalog number to "CBX7". Three pole series connection will be provided. Ex: Change **CX7-9-10-***0.16A-A10-WG to **CBX7-9-10-***0.16A-A10-WJ.

- ③ A red and yellow handle may be selected instead of the standard gray and black handle. Change "WG" suffix to "WJ". Ex: Change **CX7-9-10-***0.16A-A10-WG to **CX7-9-10-***0.16A-A10-WJ.
- ④ Other voltages available, see Section A in this catalog.
- ⑤ KAIC Assembly Rating Index. See pages F73-F76 for Application Rating Guide.
- ⑥ Catalog number (-A10) includes front-mounted auxiliary KT9-PE1-10 with 250 VAC maximum control circuit matching line voltage, or provided from separate source, used to de-energize contactor coil under fault condition (auxiliary not available for customer use). For control circuits greater than 300 VAC, which is common with line voltage, the auxiliary will not be wired into the control circuit since the contactor coil will be de-energized when KTA9 is tripped due to overload or short circuit; therefore, the KT9-PE1-10 auxiliary is available for customer use.

Enclosed Non-Reversing Combination Controller, Electronic DC Coil - Type 4 / 12

Amp / Horsepower Rating					Painted Steel, Type 4 / 12 Enclosur3		Catalog Number ③	Dimension Code
Max. Horsepower ①②				O/L Relay Ampere Range	Magnetic Response Current	Interrupting Capacity		
Three Phase								
200V	230V	460V	575V					
KTA9-32S Standard Interrupting Capacity								
~	~	~	~	0.10...0.16	2.2	CX7-9E-10-* -AS0.16A-A10-WG	W6	
~	~	~	~	0.16...0.25	3.5	CX7-9E-10-* -AS0.25A-A10-WG	W6	
~	~	~	~	0.25...0.40	5.6	CX7-9E-10-* -AS0.4A-A10-WG	W6	
~	~	~	~	0.40...0.63	8.8	CX7-9E-10-* -AS0.63A-A10-WG	W6	
~	~	1/2	1/2	0.63...1.0	14	CX7-9E-10-* -AS1.0A-A10-WG	W6	
~	~	3/4	~	1.0...1.6	22	CX7-9E-10-* -AS1.6A-A10-WG	W6	
1/2	1/2	1	1-1/2	1.6...2.5	35	CX7-9E-10-* -AS2.5A-A10-WG	W6	
3/4	3/4	2	3	2.5...4.0	52	CX7-9E-10-* -AS4.0A-A10-WG	W6	
1	1-1/2	3	~	4.0...6.3	88	CX7-9E-10-* -AS6.3A-A10-WG	W6	
2	2	5	~	6.3...10	140	CX7-12E-10-* -AS10A-A10-WG	W6	
3	5	10	~	10...16	224	CX7-16E-10-* -AS16A-A10-WG	W6	
KTA9-40H High Interrupting Capacity								
~	~	~	~	0.40...0.63	8.8	CX7-9E-10-* -AH0.63A-A10-WG	W6	
~	~	1/2	1/2	0.63...1.0	14	CX7-9E-10-* -AH1.0A-A10-WG	W6	
~	~	3/4	~	1.0...1.6	22	CX7-9E-10-* -AH1.6A-A10-WG	W6	
1/2	1/2	1	1-1/2	1.6...2.5	33	CX7-9E-10-* -AH2.5A-A10-WG	W6	
3/4	3/4	2	3	2.5...4.0	52	CX7-9E-10-* -AH4.0A-A10-WG	W6	
1	1-1/2	3	5	4.0...6.3	82	CX7-9E-10-* -AH6.3A-A10-WG	W6	
2	2	5	7-1/2	6.3...10	130	CX7-12E-10-* -AH10A-A10-WG	W6	
3	5	10	10	10...16	208	CX7-16E-10-* -AH16A-A10-WG	W6	
5	5	10	~	14.5...20	260	CX7-23E-10-* -AH20A-A10-WG	W6	
5	7-1/2	15	~	18...25	325	CX7-23E-10-* -AH25A-A10-WG	W6	
7-1/2	10	20	~	24...29	406	CX7-30E-10-* -AH29A-A10-WG	W6	
7-1/2	10	25	~	27...32	448	CX7-37E-10-* -AH32A-A10-WG	W6	
10	10	25	~	30...36	432	CX7-37E-10-* -AH36A-A10-WG	W6	
10	10	30	~	34...40	480	CX7-43E-10-* -AH40A-A10-WG	W6	
KTA7-45H High Interrupting Capacity								
3	3	7-1/2	10	6.3...10	130	CX7-30E-10-* -AH10A-A10-WG	W7	
5	5	10	15	10...16	208	CX7-30E-10-* -AH16A-A10-WG	W7	
5	7-1/2	15	20	14.5...20	260	CX7-30E-10-* -AH20A-A10-WG	W7	
7-1/2	10	20	20	18...25	325	CX7-30E-10-* -AH25A-A10-WG	W7	
7-1/2	10	20	25	23...32	416	CX7-37E-10-* -AH32A-A10-WG	W7	
10	10	25	~	32...45	585	CX7-37E-10-* -AH45A-A10-WG	W7	
10	15	30	~	32...45	585	CX7-43E-10-* -AH45A-A10-WG	W7	



Includes:

- Type 4 / 12 enclosure - watertight, dusttight
- KT9 "Type E/F" Combination Motor Controller with 1 NO front mount Auxiliary Contact (Cat #: KT9-PE1-10)
- Terminal Adaptor for Type E Applications (Cat.# KT9-40-TE or KT7-45-TE)
- CA7 contactor (for remote operation), Electronic DC coil
- Power wiring
- Gray and black Type 4/4X/12; IP66 handle (Cat.# KT9-HTN) ⑤
- Pilot device shown is factory installed option

See page F1.77 for factory installed modifications

Contactor Electronic DC Coil Codes (*) ④

DC Coil Codes	Voltage
12E	12V
24E	24V
36E	36-48V
48E	48-72V
110E	110-125V
220E	220-250V

① Horsepower ratings shown in the table above are for reference. *The final selection of the controller depends on the actual motor full load current and service factor.*

- For motor with service factor less than 1.15. Use motor nameplate full load current times 0.9 and choose the motor starter with the appropriate current rating. Example: Motor FLC = 4.2A; S.F. = 1.0. 4.2A x 0.9 = 3.78A. Select catalog number KTA9-32S-4.0A.

② CX7 may be applied to single phase loads. Contact factory for these specifications.

③ A red and yellow handle may be selected instead of the standard gray and black handle. Change "WG" suffix to "WJ". Ex: Change CX7-9E-10-*****-0.16A-A10-**WG** to CX7-9E-10-*****-0.16A-A10-**WJ**.

④ CX7-9E...43E with electronic coils are not interchangeable with non-electronic DC or AC coils.

⑤ KAIC Assembly Rating Index. See pages F73-F76 for Application Rating Guide.

Ordering Instructions

Specify Catalog Number	
Replace (*) with Coil Code	See Coil Code tables on this page for codes
Select modifications if required	

Enclosed Reversing Combination Controller, AC Operation - Type 4 / 12

Amp / Horsepower Rating					Painted Steel, Type 4 / 12 Enclosure		Dimension Code
Max. Horsepower ①②				O/L Relay Ampere Range	Magnetic Response Current	Catalog Number ③④	
Three Phase							
200V	230V	460V	575V				
KTA9-32S Standard Interrupting Capacity							
~	~	~	~	0.10...0.16	2.2	CXU7-9-10-*AS0.16A-A10-WG	W6
~	~	~	~	0.16...0.25	3.5	CXU7-9-10-*AS0.25A-A10-WG	W6
~	~	~	~	0.25...0.40	5.6	CXU7-9-10-*AS0.40A-A10-WG	W6
~	~	~	~	0.40...0.63	8.8	CXU7-9-10-*AS0.63A-A10-WG	W6
~	~	1/2	1/2	0.63...1.0	14	CXU7-9-10-*AS1.0A-A10-WG	W6
~	~	3/4	~	1.0...1.6	22	CXU7-9-10-*AS1.6A-A10-WG	W6
1/2	1/2	1	1-1/2	1.6...2.5	35	CXU7-9-10-*AS2.5A-A10-WG	W6
3/4	3/4	2	3	2.5...4.0	52	CXU7-9-10-*AS4.0A-A10-WG	W6
1	1-1/2	3	~	4.0...6.3	88	CXU7-9-10-*AS6.3A-A10-WG	W6
2	2	5	~	6.3...10	140	CXU7-12-10-*AS10A-A10-WG	W6
3	5	10	~	10...16	224	CXU7-16-10-*AS16A-A10-WG	W6
KTA9-40H High Interrupting Capacity							
~	~	~	~	0.40...0.63	8.8	CXU7-9-10-*AH0.63A-A10-WG	W6
~	~	1/2	1/2	0.63...1.0	14	CXU7-9-10-*AH1.0A-A10-WG	W6
~	~	3/4	~	1.0...1.6	22	CXU7-9-10-*AH1.6A-A10-WG	W6
1/2	1/2	1	1-1/2	1.6...2.5	33	CXU7-9-10-*AH2.5A-A10-WG	W6
3/4	3/4	2	3	2.5...4.0	52	CXU7-9-10-*AH4.0A-A10-WG	W6
1	1-1/2	3	5	4.0...6.3	82	CXU7-9-10-*AH6.3A-A10-WG	W6
2	2	5	7-1/2	6.3...10	130	CXU7-12-10-*AH10A-A10-WG	W6
3	5	10	10	10...16	208	CXU7-16-10-*AH16A-A10-WG	W6
5	5	10	~	14.5...20	260	CXU7-23-10-*AH20A-A10-WG	W6
5	7-1/2	15	~	18...25	325	CXU7-23-10-*AH25A-A10-WG	W6
7-1/2	10	20	~	24...29	406	CXU7-30-10-*AH29A-A10-WG	W6
7-1/2	10	25	~	27...32	448	CXU7-37-10-*AH32A-A10-WG	W6
10	10	25	~	30...36	432	CXU7-37-10-*AH36A-A10-WG	W6
10	10	30	~	34...40	480	CXU7-43-10-*AH40A-A10-WG	W6
KTA9-45H High Interrupting Capacity							
3	3	7-1/2	10	6.3...10	130	CXU7-30-22-*AH10A-A10-WG	W7
5	5	10	15	10...16	208	CXU7-30-22-*AH16A-A10-WG	W7
5	7-1/2	15	20	14.5...20	260	CXU7-30-22-*AH20A-A10-WG	W7
7-1/2	10	20	20	18...25	325	CXU7-30-22-*AH25A-A10-WG	W7
7-1/2	10	20	25	23...32	416	CXU7-37-22-*AH32A-A10-WG	W7
10	10	25	~	32...45	585	CXU7-37-22-*AH45A-A10-WG	W7
10	15	30	~	32...45	585	CXU7-43-22-*AH45A-A10-WG	W7



Includes:

- Type 4 / 12 enclosure - watertight, dustight
- KT9 "Type E/F" Combination Motor Controller with 1 NO front mount Auxiliary Contact (Cat #: KT9-PE1-10)
- Terminal Adaptor for Type E Applications (Cat.# KT9-40-TE or KT7-45-TE)
- CA7 contactors (for remote operation), AC coil
- Power wiring
- Gray and black Type 4/4X/12; IP66 handle (Cat.# KT9-HTN) ③
- Control power transformer, pilot device, terminals and other equipment shown are factory installed options

See page F1.77 for factory installed modifications

Contactor AC Coil Codes (*) ⑤

AC Coil Code	Voltage Range	
	50 Hz	60 Hz
024Z	24V	24V
0120	110V	120V
220W	200-220V	208-240V
0415	400-415V	~
0480 ⑥	440V	480V
0600 ⑥	550V	600V

① Horsepower ratings shown in the table above are for reference. The final selection of the controller depends on the actual motor full load current and service factor.

- For motor with service factor less than 1.15. Use motor nameplate full load current times 0.9 and choose the motor starter with the appropriate current range. Example: Motor FLC = 4.2A; S.F. = 1.0. 4.2A x 0.9 = 3.78A. Select catalog number KTA9-32S-4.0A.
- ② CXU7 may be applied to single phase loads. Contact factory for these applications.
- ③ A red and yellow handle may be selected instead of the standard gray and black handle. Change "WG" suffix to "WJ". Ex: Change CXU7-9-10-*0.16A-A10-WG to CXU7-9-10-*0.16A-A10-WJ.
- ④ Other voltages available, see Section A in this catalog.

- ⑤ KAIC Assembly Rating Index. See pages F73-F76 for Application Rating Guide.
- ⑥ Catalog number (-A10) includes front-mounted auxiliary KT9-PE1-10 with 250 VAC maximum control circuit matching line voltage, or provided from separate source, used to de-energize contactor coil under fault condition (auxiliary not available for customer use). For control circuits greater than 300 VAC, which is common with line voltage, the auxiliary will not be wired into the control circuit since the contactor coil will be de-energized when KTA9 is tripped due to overload or short circuit; therefore, the KT9-PE1-10 auxiliary is available for customer use.

Enclosed Reversing Combination Controller, Electronic DC Coil - Type 4 / 12

Amp / Horsepower Rating					Painted Steel, Type 4 / 12 Enclosure		Dimension Code
Max. Horsepower ①②				O/L Relay Ampere Range	Magnetic Response Current	Catalog Number ③	
Three Phase							
200V	230V	460V	575V				
KTA9-32S Standard Interrupting Capacity							
~	~	~	~	0.10...0.16	2.2	CXU7-9E-10-*-AS0.16A-A10-WG	W6
~	~	~	~	0.16...0.25	3.5	CXU7-9E-10-*-AS0.25A-A10-WG	W6
~	~	~	~	0.25...0.40	5.6	CXU7-9E-10-*-AS0.40A-A10-WG	W6
~	~	~	~	0.40...0.63	8.8	CXU7-9E-10-*-AS0.63A-A10-WG	W6
~	~	1/2	1/2	0.63...1.0	14	CXU7-9E-10-*-AS1.0A-A10-WG	W6
~	~	3/4	~	1.0...1.6	22	CXU7-9E-10-*-AS1.6A-A10-WG	W6
1/2	1/2	1	1-1/2	1.6...2.5	35	CXU7-9E-10-*-AS2.5A-A10-WG	W6
3/4	3/4	2	3	2.5...4.0	52	CXU7-9E-10-*-AS4.0A-A10-WG	W6
1	1-1/2	3	~	4.0...6.3	88	CXU7-9E-10-*-AS6.3A-A10-WG	W6
2	2	5	~	6.3...10	140	CXU7-12E-10-*-AS10A-A10-WG	W6
3	5	10	~	10...16	224	CXU7-16E-10-*-AS16A-A10-WG	W6
KTA9-40H High Interrupting Capacity							
~	~	~	~	0.40...0.63	8.8	CXU7-9E-10-*-AH0.63A-A10-WG	W6
~	~	1/2	1/2	0.63...1.0	14	CXU7-9E-10-*-AH1.0A-A10-WG	W6
~	~	3/4	~	1.0...1.6	22	CXU7-9E-10-*-AH1.6A-A10-WG	W6
1/2	1/2	1	1-1/2	1.6...2.5	33	CXU7-9E-10-*-AH2.5A-A10-WG	W6
3/4	3/4	2	3	2.5...4.0	52	CXU7-9E-10-*-AH4.0A-A10-WG	W6
1	1-1/2	3	5	4.0...6.3	82	CXU7-9E-10-*-AH6.3A-A10-WG	W6
2	2	5	7-1/2	6.3...10	130	CXU7-12E-10-*-AH10A-A10-WG	W6
3	5	10	10	10...16	208	CXU7-16E-10-*-AH16A-A10-WG	W6
5	5	10	~	14.5...20	260	CXU7-23E-10-*-AH20A-A10-WG	W6
5	7-1/2	15	~	18...25	325	CXU7-23E-10-*-AH25A-A10-WG	W6
7-1/2	10	20	~	24...29	406	CXU7-30E-10-*-AH29A-A10-WG	W6
7-1/2	10	25	~	27...32	448	CXU7-37E-10-*-AH32A-A10-WG	W6
10	10	25	~	30...36	432	CXU7-37E-10-*-AH36A-A10-WG	W6
10	10	30	~	34...40	480	CXU7-43E-10-*-AH40A-A10-WG	W6
KTA7-45H High Interrupting Capacity							
3	3	7-1/2	10	6.3...10	130	CXU7-30E-22-*-AH10A-A10-WG	W7
5	5	10	15	10...16	208	CXU7-30E-22-*-AH16A-A10-WG	W7
5	7-1/2	15	20	14.5...20	260	CXU7-30E-22-*-AH20A-A10-WG	W7
7-1/2	10	20	20	18...25	325	CXU7-30E-22-*-AH25A-A10-WG	W7
7-1/2	10	20	25	23...32	416	CXU7-37E-22-*-AH32A-A10-WG	W7
10	10	25	~	32...45	585	CXU7-37E-22-*-AH45A-A10-WG	W7
10	15	30	~	32...45	585	CXU7-43E-22-*-AH45A-A10-WG	W7



Includes:

- Type 4 / 12 enclosure - watertight, dusttight
- KTA9 "Type E/F" Combination Motor Controller with 1 NO front mount Auxiliary Contact (Cat #: KT9-PE1-10)
- Terminal Adaptor for Type E Applications (Cat.# KT9-40-TE or KT7-45-TE)
- CA7 contactors (for remote operation), Electronic DC coil
- Power wiring
- Gray and black Type 4/4X/12; IP66 handle (Cat.# KT9-HTN) ④
- Control power transformer, pilot device, terminals and other equipment shown are factory installed options

See page F1.77 for factory installed modifications

Contactors Electronic DC Coil Codes (*) ④

DC Coil Codes	Voltage
12E	12V
24E	24V
36E	36-48V
48E	48-72V
110E	110-125V
220E	220-250V

Ordering Instructions

Specify Catalog Number	
Replace (*) with Coil Code Select modifications if required	See Coil Code tables on this page for codes

① Horsepower ratings shown in the table above are for reference. The final selection of the controller depends on the actual motor full load current and service factor.

- For motor with service factor less than 1.15. Use motor nameplate full load current times 0.9 and choose the motor starter with the appropriate current range. Example: Motor FLC = 4.2A; S.F. = 1.0. 4.2A x 0.9 = 3.78A. Select catalog number KTA9-32S-4.0A.

② CXU7 may be applied to single phase loads. Contact factory for these applications.

③ A red and yellow handle may be selected instead of the standard gray and black handle. Change "WG" suffix to "WJ". Ex: Change CXU7-9E-10-*-0.16A-A10-WG to CXU7-9E-10-*-0.16A-A10-WJ.

④ CXU7-9E...43E with electronic coils are not interchangeable with non-electronic DC or AC coils.

⑤ KAIC Assembly Rating Index. See pages F73-F76 for Application Rating Guide.

Non-Reversing and Reversing CX7 Combination Controller Modifications (Factory Assembled)

Description	Add Suffix to Catalog Number
Pilot Devices ①	
START-STOP multi-function pushbutton	3U
ON-OFF multi-function pushbutton	4U
FOR-STOP-REV multi-function pushbutton	3U
UP-STOP-DOWN multi-function pushbutton	4U
OPEN-STOP-CLOSE multi-function pushbutton	5U
HAND-AUTO selector switch	5
OFF-ON selector switch	6
HAND-OFF-AUTO selector switch	7
FOR-OFF-REV selector switch	6
UP-OFF-DOWN selector switch	7
OPEN-OFF-CLOSE selector switch	8
Pilot light only ③	1
Pilot lights only (2) ③	2
Pilot light w/ START-STOP multi-function pushbutton ③	13U
Pilot light w/ ON-OFF multi-function pushbutton ③	14U
Pilot light w/ HAND-AUTO selector switch ③	15
Pilot light w/ OFF-ON selector switch ③	16
Pilot light w/ HAND-OFF-AUTO selector switch ③	17
Control Power Transformer	
(with fused primary and secondary)	Replace (*) in catalog # with the following codes ②
<i>Primary volts</i>	<i>Secondary volts</i>
208	120
240	120
480	120
575	120
380	110
240	24
480	24
600	24
50 watt Standard Capacity	XA
	XB
	XC
	XD
	XG
	XE
	XF
	XJ
KT9 Auxiliaries & Trip Contacts ⑤	
Front mount 250V maximum	
1 NO + 1 NC Auxiliary	-C
2 NO Auxiliaries	-D
1 NO SC+OL + 1 NC Auxiliary	-R
1 NO SC+OL + 1 NO Auxiliary	-S
Side Mount 600V maximum	
2 NC Auxiliaries	-AS02
2 NO Auxiliaries	-AS20
1 NO + 1 NC Auxiliary	-AS11
1 NC SC+OL + 1 NO Auxiliary	-R10
1 NC SC+OL + 1 NC Auxiliary	-R11

Description	Add Suffix to Catalog Number
Additional KT9 Trip Contacts - Side Mount (600V max)	
1 NO SC+OL + 1 NO SC	-R00
1 NO SC+OL + 1 NC SC	-R01
1 NC SC+OL + 1 NO SC	-R10
KT9 Accessories	
Undervoltage Release Module	Select coil voltage from table below
Shunt Release Module	-UA-* -AA-*
CA7 Auxiliary Contacts ⑥	
1 NO Auxiliary	-S10
1 NC Auxiliary	-S01
1 NO + 1 NC Auxiliary	-S11
2 NO Auxiliaries	-S20
2 NC Auxiliaries	-S02
1 NO + 2 NC Auxiliary	-S12
2 NO + 1 NC Auxiliary	-S21
3 NO Auxiliaries	-S30
3 NC Auxiliaries	-S03
1 NO + 3 NC Auxiliary	-S13
3 NO + 1 NC Auxiliary	-S31
2 NO + 2 NC Auxiliary	-S22
4 NO Auxiliaries	-S40
4 NC Auxiliaries	-S04
Alternate Aux. Contact Arrangement (CA7 only)	
1 NC in lieu of standard 1 NO	-SX10
2 NC in lieu of standard 2 NO (on CXU7 only)	-SX2
CA7 Contactor Accessories	
Electronic Interface	-JE ④
Surge Suppressor RC	-RC
Surge Suppressor Varistor	-V
Unwired Terminal Blocks Specify quantity (▼)	-▼TB

-UA..-AA Coil Codes (*)

AC Coil Code	Voltage Range	
	50 Hz	60 Hz
24V	24V	24V...28V
120V	110V	120V
230V	220...230V	~
260V	~	240...260V
277V	~	277V
400V	380...400V	~
480V	415V	480V

① Currently supply D7 multi-function pushbuttons as standard which do not require protective boots to meet Type 4X. See Section H in this catalog for description (all suffix's ending in "U").
 ② Factory modifications often change the enclosure size. Refer to factory for dimensions when critical to the installation.

③ Pilot Lights may be applied with 24VAC/VDC, 120VAC or 240VAC Control Circuit. Pilot Lights with 277 VAC...575VAC require a control circuit transformer.
 ④ CR17E-24 will be used. CR17E-12 by special order only.
 ⑤ Additional auxiliaries are per contactor. Number of auxiliaries is double for reversing applications.

CX7 Explosion Proof Combination Controllers - NEMA Type 4/4X/7/9 with Type 4 Gaskets

Amp / Horsepower Rating								
Max. Horsepower ①②③				O/L Relay Ampere Range	Magnetic Response Current	Catalog Number ④	Dimension Code	
Three Phase								
200V	230V	460V	575V					
KT A9-32S Standard Interrupting Capacity								
~	~	~	~	0.10...0.16	2.2	CX7-9-10-* -AS0.16A-A10-EZ	EZ	
~	~	~	~	0.16...0.25	3.5	CX7-9-10-* -AS0.25A-A10-EZ	EZ	
~	~	~	~	0.25...0.40	5.6	CX7-9-10-* -AS0.4A-A10-EZ	EZ	
~	~	~	~	0.40...0.63	8.8	CX7-9-10-* -AS0.63A-A10-EZ	EZ	
~	~	1/2	1/2	0.63...1.0	14	CX7-9-10-* -AS1A-A10-EZ	EZ	
~	~	3/4	~	1.0...1.6	22	CX7-9-10-* -AS1.6A-A10-EZ	EZ	
1/2	1/2	1	1-1/2	1.6...2.5	35	CX7-9-10-* -AS2.5A-A10-EZ	EZ	
3/4	3/4	2	3	2.5...4.0	52	CX7-9-10-* -AS4A-A10-EZ	EZ	
1	1-1/2	3	~	4.0...6.3	88	CX7-9-10-* -AS6.3A-A10-EZ	EZ	
2	2	5	~	6.3...10	140	CX7-12-10-* -AS10A-A10-EZ	EZ	
3	5	10	~	10...16	224	CX7-16-10-* -AS16A-A10-EZ	EZ	
KT A9-40H High Interrupting Capacity								
~	~	~	~	0.40...0.63	8.8	CX7-9-10-* -AH0.63A-A10-EZ	EZ	
~	~	1/2	1/2	0.63...1.0	14	CX7-9-10-* -AH1.0A-A10-EZ	EZ	
~	~	3/4	~	1.0...1.6	22	CX7-9-10-* -AH1.6A-A10-EZ	EZ	
1/2	1/2	1	1-1/2	1.6...2.5	33	CX7-9-10-* -AH2.5A-A10-EZ	EZ	
3/4	3/4	2	3	2.5...4.0	52	CX7-9-10-* -AH4A-A10-EZ	EZ	
1	1-1/2	3	5	4.0...6.3	82	CX7-9-10-* -AH6.3A-A10-EZ	EZ	
2	2	5	7-1/2	6.3...10	130	CX7-12-10-* -AH10A-A10-EZ	EZ	
3	5	10	10	10...16	208	CX7-16-10-* -AH16A-A10-EZ	EZ	
5	5	10	~	14.5...20	260	CX7-23-10-* -AH20A-A10-EZ	EZ	
5	7-1/2	15	~	18...25	325	CX7-23-10-* -AH25A-A10-EZ	EZ	
7-1/2	10	20	~	24...29	406	CX7-23-10-* -AH29A-A10-EZ	EZ	
7-1/2	10	25	~	27...32	448	CX7-23-10-* -AH32A-A10-EZ	EZ	
10	10	25	~	30...36	432	CX7-23-10-* -AH36A-A10-EZ	EZ	
10	10	30	~	34...40	480	CX7-23-10-* -AH40A-A10-EZ	EZ	
KT A7-45H High Interrupting Capacity								
3	3	7-1/2	10	6.3...10	130	CX7-30-10-* -AH10A-A10-EZ	EZ	
5	5	10	15	10...16	208	CX7-30-10-* -AH16A-A10-EZ	EZ	
5	7-1/2	15	20	14.5...20	260	CX7-30-10-* -AH20A-A10-EZ	EZ	
7-1/2	10	20	20	18...25	325	CX7-30-10-* -AH25A-A10-EZ	EZ	
7-1/2	10	20	25	23...32	416	CX7-30-10-* -AH32A-A10-EZ	EZ	
10	10	25	~	32...45	585	CX7-37-10-* -AH45A-A10-EZ	EZ	
10	15	30	~	32...45	585	CX7-43-10-* -AH45A-A10-EZ	EZ	

Includes:

- Class I, Div I, Group B, C & D – Class II, Div I, Group E, F & G enclosure Class III, Zone I, IIB & H2
- KT9 “Type E” Self-protected Combination Manual Motor Controller with 1 NO front mount auxiliary contact (Cat.# KT9-PE1-10)
- Terminal Adaptor for Combo Type E/F Applications (Cat.# KT9-40-TE or KT7-45-TE)
- CA7 contactor (for remote operation), AC coil
- Power wiring

Modifications (Factory Assembled)

KT9 Auxiliaries & Trip Contacts,	
Front Mount 250V max. 1 NC Auxiliary 1 NO + 1 NC Auxiliary 2 NO Auxiliaries	-A -C -D
1 NO SC + OL + 1 NC Auxiliary 1 NO SC + OL + 1 NO Auxiliary	-R -S
Side Mount 600V max. 2 NO Auxiliaries 1 NO + 1 NC Auxiliary 1 NC SC + OL + 1 NO Auxiliary 1 NC SC + OL + 1 NC Auxiliary	-AS20 -AS11 -R10 -R11
CA7 Contactor Accessories	Add Suffix to Cat. Number
1 NC Auxiliary 1 NO Auxiliary	-S01 -S10
Electronic Interface Surge Suppressor RC Surge Suppressor Varistor	-JE -RC -V
Enclosure Modifications Dual START/STOP pushbutton ON/OFF selector switch H-O-A Breather/Drain	3 6 7 -BD

Contactor AC Coil Codes (*) ④

AC Coil Code	Voltage Range	
	50 Hz	60 Hz
024Z	24V	24V
0120	110V	120V
220W	200-220V	208-240V
0415	400-415V	~
0480 ⑥	440V	480V
0600 ⑥	550V	600V

① Horsepower ratings shown in the table above are for reference. The final selection of the controller depends on the actual motor full load current and service factor.

- For motor with service factor less than 1.15. Use motor nameplate full load current times 0.9 and choose the motor starter with the appropriate current range. Example: Motor FLC = 4.2A; S.F. = 1.0. 4.2A x 0.9 = 3.78A. Select catalog number KTA9-32S-4.0A.
- ② Magnetic trip is fixed at 14x the maximum value of the current adjustment range.
- ③ CX7 may be applied to single phase loads. See footnote 1 for device selection criteria. To order single phase unit, change “CX7” in catalog number to “CBX7”. Three pole series connection will be provided. Ex: Change **CX7-9-10-***-0.16A-A10-EZ to **CBX7-9-10-***-0.16A-A10-EZ.
- ④ Other voltages available, see Section A in this catalog.

Ordering Instructions

Specify Catalog Number	
Replace (*) with Coil Code	See tables on this page for codes
Select modifications if required	

- ⑤ Catalog number (-A10) includes front-mounted auxiliary KT9-PE1-10 with 300 VAC maximum control circuit matching line voltage, or provided from separate source, used to de-energize contactor coil under fault condition (auxiliary not available for customer use). For control circuits greater than 300 VAC, which is common with line voltage, the auxiliary will not be wired into the control circuit since the contactor coil will be de-energized when KTA9 is tripped due to overload or short circuit; therefore, the KT9-PE1-10 auxiliary is available for customer use.

Enclosed Motor Circuit Controllers

Type E/F Simplex & Duplex Pump Controllers



Simplex Pump Controllers

A single KTA7 motor controller plus matching CA7 contactor can be combined in an enclosure as a Simplex Combination Controller for pumping applications. Additional space is provided for the customer to field addition of time clocks or float switches as required by the application. An environmentally approved thru-the-door handle provides for a required disconnect. These pump panels can be supplied with Suitable for Service Entrance (SUSE) label on demand. Type E/F pump panels are less expensive than the classic Construction Type A (Fusible) or Construction Type C (MCCB) versions shown in Section C of this catalog.

Type E/F Simplex Pump Controller Panels include:

- Contactor (with AC coil)
- Type E Self-protected motor controller
- “START” Momentary Push Button
- “HOA” Selector Switch
- A minimum of 6” x 10” extra back pan space
- UL Type rated enclosure

Duplex Pump Controllers

Two starter duplex panels can be fed from one power source or two power sources and include lead/lag control circuitry to meet customers’ need in pumping and many other applications. Two environmentally approved thru-the-door handle disconnect mechanisms means no main feeder device is required and smaller and less expensive panel than a classic duplex panel as offered in Section C of this catalog. The following pages include a selection of duplex controllers and you can contact your Sprecher + Schuh representative to modify the selection.

Type E/F Duplex Pump Controller Panels include:

- (2) Contactors (AC coil) and (2) Type E/F self protected motor controllers
- (1) Electronic alternating relay
- (1) UL type rated enclosure
- Designed per alternation control diagram shown at bottom of page F1.85

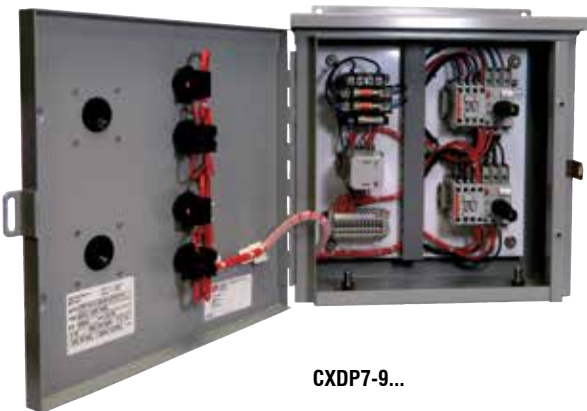

F
Enclosed Motor Circuit Controllers

Series CXP7 & Type E/F Combo Pump Panel

Max. Horsepower ①②③ Three Phase				Current Adjustment Range (A)	Magnetic Response Current	Type 3R Rainproof (Metal)	Dimension Code	Type 4X Watertight Corrosion Resistant Non-metallic	Dimension Code
200V	230V	460V	575V			Catalog Number ④⑤		Catalog Number ④⑥	
KTA9-32S Standard Interrupting Capacity									
~	~	~	~	0.10...0.16	2.2	CXP7-9-10-*-AS0.16A-A10-RG	0	CXP7-9-10-*-AS0.16A-A10-CG	R/F
~	~	~	~	0.16...0.25	3.5	CXP7-9-10-*-AS0.25A-A10-RG	0	CXP7-9-10-*-AS0.25A-A10-CG	R/F
~	~	~	~	0.25...0.40	5.6	CXP7-9-10-*-AS0.40A-A10-RG	0	CXP7-9-10-*-AS0.40A-A10-CG	R/F
~	~	~	~	0.40...0.63	8.8	CXP7-9-10-*-AS0.63A-A10-RG	0	CXP7-9-10-*-AS0.63A-A10-CG	R/F
~	~	1/2	1/2	0.63...1.0	14	CXP7-9-10-*-AS1.0A-A10-RG	0	CXP7-9-10-*-AS1.0A-A10-CG	R/F
~	~	3/4	~	1.0...1.6	22	CXP7-9-10-*-AS1.6A-A10-RG	0	CXP7-9-10-*-AS1.6A-A10-CG	R/F
1/2	1/2	1	1-1/2	1.6...2.5	35	CXP7-9-10-*-AS2.5A-A10-RG	0	CXP7-9-10-*-AS2.5A-A10-CG	R/F
3/4	3/4	2	3	2.5...4.0	52	CXP7-9-10-*-AS4.0A-A10-RG	0	CXP7-9-10-*-AS4.0A-A10-CG	R/F
1	1-1/2	3	~	4.0...6.3	88	CXP7-9-10-*-AS6.3A-A10-RG	0	CXP7-9-10-*-AS6.3A-A10-CG	R/F
2	2	5	~	6.3...10	140	CXP7-12-10-*-AS10A-A10-RG	0	CXP7-12-10-*-AS10A-A10-CG	R/F
3	5	10	~	10...16	224	CXP7-16-10-*-AS16A-A10-RG	0	CXP7-16-10-*-AS16A-A10-CG	R/F
KTA9-40H High Interrupting Capacity									
~	~	~	~	0.40...0.63	8.8	CXP7-9-10-*-AH0.63A-A10-RG	0	CXP7-9-10-*-AH0.63A-A10-CG	R/F
~	~	1/2	1/2	0.63...1.0	14	CXP7-9-10-*-AH1.0A-A10-RG	0	CXP7-9-10-*-AH1.0A-A10-CG	R/F
~	~	3/4	~	1.0...1.6	22	CXP7-9-10-*-AH1.6A-A10-RG	0	CXP7-9-10-*-AH1.6A-A10-CG	R/F
1/2	1/2	1	1-1/2	1.6...2.5	33	CXP7-9-10-*-AH2.5A-A10-RG	0	CXP7-9-10-*-AH2.5A-A10-CG	R/F
3/4	3/4	2	3	2.5...4.0	52	CXP7-9-10-*-AH4.0A-A10-RG	0	CXP7-9-10-*-AH4.0A-A10-CG	R/F
1	1-1/2	3	5	4.0...6.3	82	CXP7-9-10-*-AH6.3A-A10-RG	0	CXP7-9-10-*-AH6.3A-A10-CG	R/F
2	2	5	7-1/2	6.3...10	130	CXP7-12-10-*-AH10A-A10-RG	0	CXP7-12-10-*-AH10A-A10-CG	R/F
3	5	10	10	10...16	208	CXP7-16-10-*-AH16A-A10-RG	0	CXP7-16-10-*-AH16A-A10-CG	R/F
5	5	10	~	14.5...20	260	CXP7-23-10-*-AH20A-A10-RG	0	CXP7-23-10-*-AH20A-A10-CG	R/F
5	7-1/2	15	~	18...25	325	CXP7-23-10-*-AH25A-A10-RG	0	CXP7-23-10-*-AH25A-A10-CG	R/F
7-1/2	10	20	~	24...29	406	CXP7-30-10-*-AH29A-A10-RG	0	CXP7-30-10-*-AH29A-A10-CG	R/F
7-1/2	10	25	~	27...32	448	CXP7-37-10-*-AH32A-A10-RG	0	CXP7-37-10-*-AH32A-A10-CG	R/F
10	10	25	~	30...36	432	CXP7-37-10-*-AH36A-A10-RG	0	CXP7-37-10-*-AH36A-A10-CG	R/F
10	10	30	~	34...40	480	CXP7-43-10-*-AH40A-A10-RG	0	CXP7-43-10-*-AH40A-A10-CG	R/F
KTA7-45H High Interrupting Capacity									
3	3	7-1/2	10	6.3...10	130	CXP7-30-10-*-AH10A-A10-RG	Q	CXP7-30-10-*-AH10A-A10-CG	R/F
5	5	10	15	10...16	208	CXP7-30-10-*-AH16A-A10-RG	Q	CXP7-30-10-*-AH16A-A10-CG	R/F
5	7-1/2	15	20	14.5...20	260	CXP7-30-10-*-AH20A-A10-RG	Q	CXP7-30-10-*-AH20A-A10-CG	R/F
7-1/2	10	20	20	18...25	325	CXP7-30-10-*-AH25A-A10-RG	Q	CXP7-30-10-*-AH25A-A10-CG	R/F
7-1/2	10	20	25	23...32	416	CXP7-30-10-*-AH32A-A10-RG	Q	CXP7-30-10-*-AH32A-A10-CG	R/F
10	10	25	~	32...45	585	CXP7-37-10-*-AH45A-A10-RG	Q	CXP7-37-10-*-AH45A-A10-CG	R/F
10	15	30	~	32...45	585	CXP7-43-10-*-AH45A-A10-RG	Q	CXP7-43-10-*-AH45A-A10-CG	R/F

NOTE: Catalog Numbers, list Prices and enclosure dimensions reflect contactors with AC coils. Contact factory for DC applications.

Contactors AC Coil Codes (*) ⑤

AC Coil Code	Voltage Range	
	50 Hz	60 Hz
024Z	24V	24V
0120	110V	120V
220W	200-220V	208-240V
0415	400-415V	~
0480 ⑥	440V	480V
0600 ⑥	550V	600V

Ordering Instructions

Specify Catalog Number	
Replace (*) with Coil Code	See this page
Factory Modifications available	Contact factory

① Horsepower ratings shown in the table above are for reference. The final selection of the controller depends on the actual motor full load current and service factor.

• For motor with service factor less than 1.15. Use motor nameplate full load current times 0.9 and choose the motor starter with the appropriate current range. Example: Motor FLC = 4.2A; S.F. = 1.0. 4.2A x 0.9 = 3.78A. Select catalog number KTA9-32S-4.0A.

② Magnetic trip is fixed at 13x the maximum value of the current adjustment range.

③ CXP7 may be applied to single phase loads. See footnote 1 for device selection criteria. To order single phase unit, change "CXP7" in catalog number to "CBX7". Three pole series connection will be provided. Ex: Change CXP7-9-10-*-0.16A-A10-RG to CBXP7-9-10-*-0.16A-A10-RG.

④ A red and yellow handle may be selected instead of the standard gray and black handle. Change "RG" suffix to "RJ". Ex: Change CXP7-9-10-*-0.16A-A10-RG to CXP7-9-10-*-0.16A-A10-RJ.

⑤ Other voltages available, see Section A in this catalog.

⑥ Catalog number (-A10) includes front-mounted auxiliary KT9-PE1-10 with 300 VAC maximum control circuit matching line voltage, or provided from separate source, used to de-energize contactor coil under fault condition (auxiliary not available for customer use). For control circuits greater than 300 VAC, which is common with line voltage, the auxiliary will not be wired into the control circuit since the contactor coil will be de-energized when KTA9 is tripped due to overload or short circuit; therefore, the KT9-PE1-10 auxiliary is available for customer use.

Series CXDP7 with Type E/F Combination Controller

Max. Horsepower Three Phase				Current Adjustment Range (A)	Magnetic Response Current	Type 3R Rainproof (Metal)	Dimension Code	Type 4X Watertight Corrosion Resistant Non-metallic	Dimension Code
200V	230V	460V	575V			Catalog Number ②		Catalog Number ②	
KTA9-32S Standard Interrupting Capacity									
~	~	~	~	0.10...0.16	2.2	CXDP7-9-10-*AS0.16A-A10-RG	R/F	CXDP7-9-10-*AS0.16A-A10-CG	R/F
~	~	~	~	0.16...0.25	3.5	CXDP7-9-10-*AS0.25A-A10-RG	R/F	CXDP7-9-10-*AS0.25A-A10-CG	R/F
~	~	~	~	0.25...0.40	5.6	CXDP7-9-10-*AS0.4A-A10-RG	R/F	CXDP7-9-10-*AS0.4A-A10-CG	R/F
~	~	~	~	0.40...0.63	8.8	CXDP7-9-10-*AS0.63A-A10-RG	R/F	CXDP7-9-10-*AS0.63A-A10-CG	R/F
~	~	1/2	1/2	0.63...1.0	14	CXDP7-9-10-*AS1A-A10-RG	R/F	CXDP7-9-10-*AS1A-A10-CG	R/F
~	~	3/4	~	1.0...1.6	22	CXDP7-9-10-*AS1.6A-A10-RG	R/F	CXDP7-9-10-*AS1.6A-A10-CG	R/F
1/2	1/2	1	1-1/2	1.6...2.5	35	CXDP7-9-10-*AS2.5A-A10-RG	R/F	CXDP7-9-10-*AS2.5A-A10-CG	R/F
3/4	3/4	2	3	2.5...4.0	52	CXDP7-9-10-*AS4A-A10-RG	R/F	CXDP7-9-10-*AS4A-A10-CG	R/F
1	1-1/2	3	~	4.0...6.3	88	CXDP7-9-10-*AS6.3A-A10-RG	R/F	CXDP7-9-10-*AS6.3A-A10-CG	R/F
2	2	5	~	6.3...10	140	CXDP7-12-10-*AS10A-A10-RG	R/F	CXDP7-12-10-*AS10A-A10-CG	R/F
3	5	10	~	10...16	224	CXDP7-16-10-*AS16A-A10-RG	R/F	CXDP7-16-10-*AS16A-A10-CG	R/F
KTA9-40H High Interrupting Capacity									
~	~	~	~	0.40...0.63	8.8	CXDP7-9-10-*AH0.63A-A10-RG	R/F	CXDP7-9-10-*AH0.63A-A10-CG	R/F
~	~	1/2	1/2	0.63...1.0	14	CXDP7-9-10-*AH1.0A-A10-RG	R/F	CXDP7-9-10-*AH1.0A-A10-CG	R/F
~	~	3/4	~	1.0...1.6	22	CXDP7-9-10-*AH1.6A-A10-RG	R/F	CXDP7-9-10-*AH1.6A-A10-CG	R/F
1/2	1/2	1	1-1/2	1.6...2.5	33	CXDP7-9-10-*AH2.5A-A10-RG	R/F	CXDP7-9-10-*AH2.5A-A10-CG	R/F
3/4	3/4	2	3	2.5...4.0	52	CXDP7-9-10-*AH4.0A-A10-RG	R/F	CXDP7-9-10-*AH4.0A-A10-CG	R/F
1	1-1/2	3	5	4.0...6.3	82	CXDP7-9-10-*AH6.3A-A10-RG	R/F	CXDP7-9-10-*AH6.3A-A10-CG	R/F
2	2	5	7-1/2	6.3...10	130	CXDP7-12-10-*AH10A-A10-RG	R/F	CXDP7-12-10-*AH10A-A10-CG	R/F
3	5	10	10	10...16	208	CXDP7-16-10-*AH16A-A10-RG	R/F	CXDP7-16-10-*AH16A-A10-CG	R/F
5	5	10	~	14.5...20	260	CXDP7-23-10-*AH20A-A10-RG	R/F	CXDP7-23-10-*AH20A-A10-CG	R/F
5	7-1/2	15	~	18...25	325	CXDP7-23-10-*AH25A-A10-RG	R/F	CXDP7-23-10-*AH25A-A10-CG	R/F
7-1/2	10	20	~	24...29	406	CXDP7-30-10-*AH29A-A10-RG	R/F	CXDP7-30-10-*AH29A-A10-CG	R/F
7-1/2	10	25	~	27...32	448	CXDP7-37-10-*AH32A-A10-RG	R/F	CXDP7-37-10-*AH32A-A10-CG	R/F
10	10	25	~	30...36	432	CXDP7-37-10-*AH36A-A10-RG	R/F	CXDP7-37-10-*AH36A-A10-CG	R/F
10	10	30	~	34...40	480	CXDP7-43-10-*AH40A-A10-RG	R/F	CXDP7-43-10-*AH40A-A10-CG	R/F
KTA7-45H High Interrupting Capacity									
3	3	7-1/2	10	6.3...10	130	CXDP7-30-10-*AH10A-A10-RG	R/F	CXDP7-30-10-*AH10A-A10-CG	R/F
5	5	10	15	10...16	208	CXDP7-30-10-*AH16A-A10-RG	R/F	CXDP7-30-10-*AH16A-A10-CG	R/F
5	7-1/2	15	20	14.5...20	260	CXDP7-30-10-*AH20A-A10-RG	R/F	CXDP7-30-10-*AH20A-A10-CG	R/F
7-1/2	10	20	20	18...25	325	CXDP7-30-10-*AH25A-A10-RG	R/F	CXDP7-30-10-*AH25A-A10-CG	R/F
7-1/2	10	20	25	23...32	416	CXDP7-30-10-*AH32A-A10-RG	R/F	CXDP7-30-10-*AH32A-A10-CG	R/F
10	10	25	~	32...45	585	CXDP7-37-10-*AH45A-A10-RG	R/F	CXDP7-37-10-*AH45A-A10-CG	R/F
10	15	30	~	32...45	585	CXDP7-43-10-*AH45A-A10-RG	R/F	CXDP7-43-10-*AH45A-A10-CG	R/F

F
Enclosed Motor Circuit Controllers

**Contactors
AC Coil Codes (*) ①**

AC Coil Code	Voltage Range	
	50 Hz	60 Hz
024Z	24V	24V
0120	110V	120V
220W	200-220V	208-240V
0415	400-415V	~
0480 ②	440V	480V
0600 ②	550V	600V

NOTE: Catalog Numbers, list Prices and enclosure dimensions reflect contactors with AC coils. Contact factory for DC applications.

R/F - Experience has shown that applications using non-metallic enclosures often require customized pump panels (i.e. Door-in-Door or unique control circuit). Contact your Sprecher + Schuh representative for a customized price.

Ordering Instructions

Specify Catalog Number	
Replace (*) with Coil Code Factory Modifications available	See this page Contact factory

- ① Other voltages available, see Section A in this catalog.
- ② Catalog number (-A10) includes front-mounted auxiliary KT9-PE1-10 with 300 VAC maximum control circuit matching line voltage, or provided from separate source, used to de-energize contactor coil under fault condition (auxiliary not available for customer use). For control circuits greater than 300 VAC, which is common with line voltage, the auxiliary will not be wired into the control circuit since the contactor coil will be de-energized when KTA9 is tripped due to overload or short circuit; therefore, the KT9-PE1-10 auxiliary is available for customer use.

Custom Multi-Starter Control Panels

From 10 to 100 or more, consult the experts

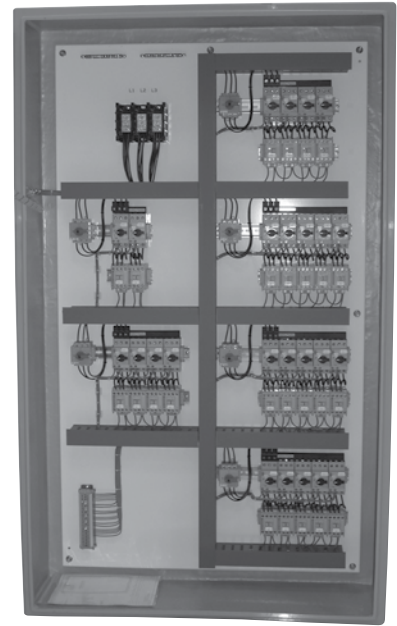
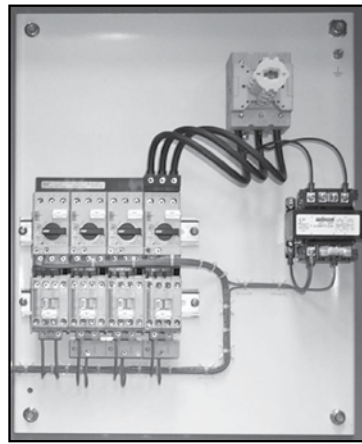

Your Motor Control + Protection Consultant

Sprecher + Schuh's slogan is "Motor control + protection consultant". This means part of our job is to be knowledgeable about these issues and to help customers choose components that not only comply with UL, NEC and CSA standards but also maximizes the SCCR rating of the assembled multi-starter panel, leading to increased protection of equipment and personnel.

Multiple KTA9, KTB9 or KTC9 motor controllers plus matching CA7 contactors can be combined in a single assembly as a multi-motor starter custom control panel. Three, 33, 133 or more motor controllers and KTU9 molded case circuit breakers, as well as other power components and control circuits, can be designed and

assembled into a custom multi-motor starter by Sprecher + Schuh to meet customers' unique application requirements. These pages include a few pictures of custom multi-starter control panels built by Sprecher + Schuh. Contact your Sprecher + Schuh motor control and protection representative for consultation regarding design, quotations, or help explaining the complex UL, NEC and CSA codes that apply to a custom assembly.

F

Enclosed Motor Circuit Controllers

For your Custom application

contact
customquotes@sprecherschuh.com

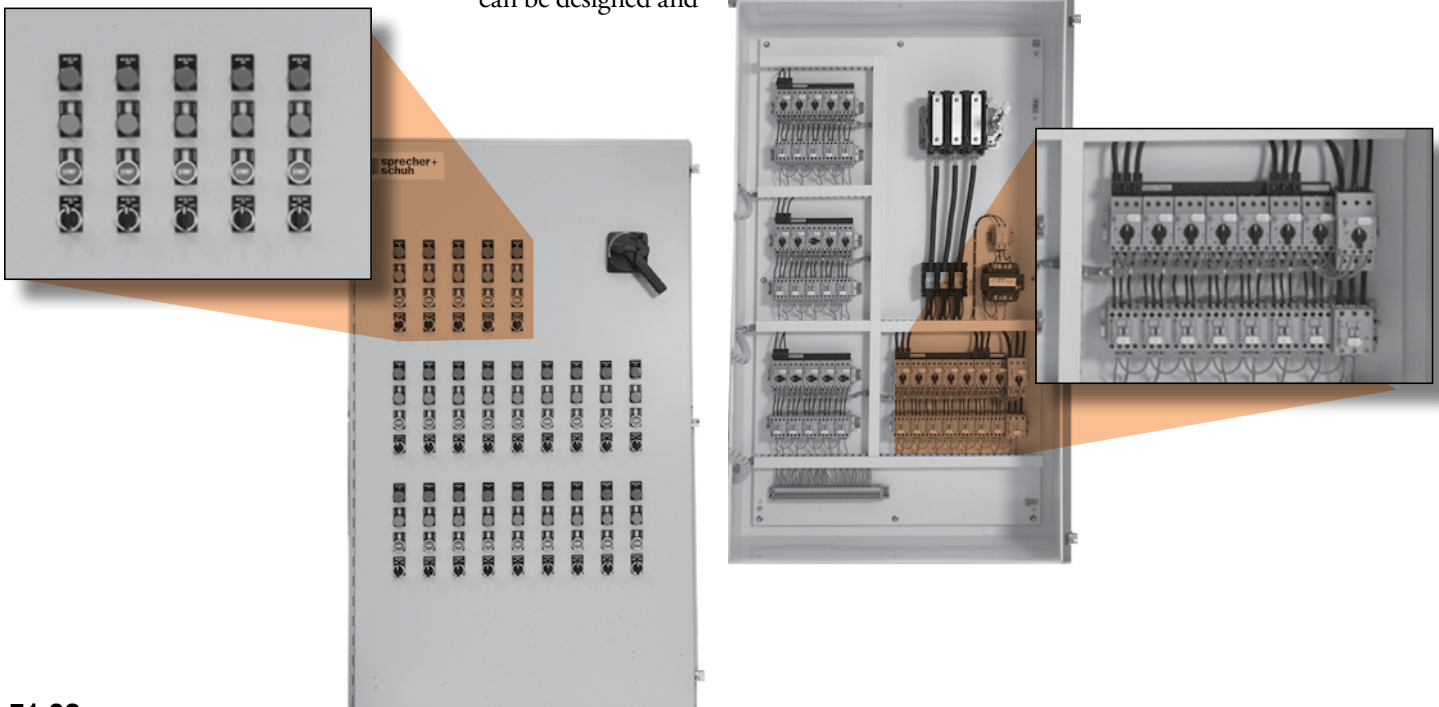

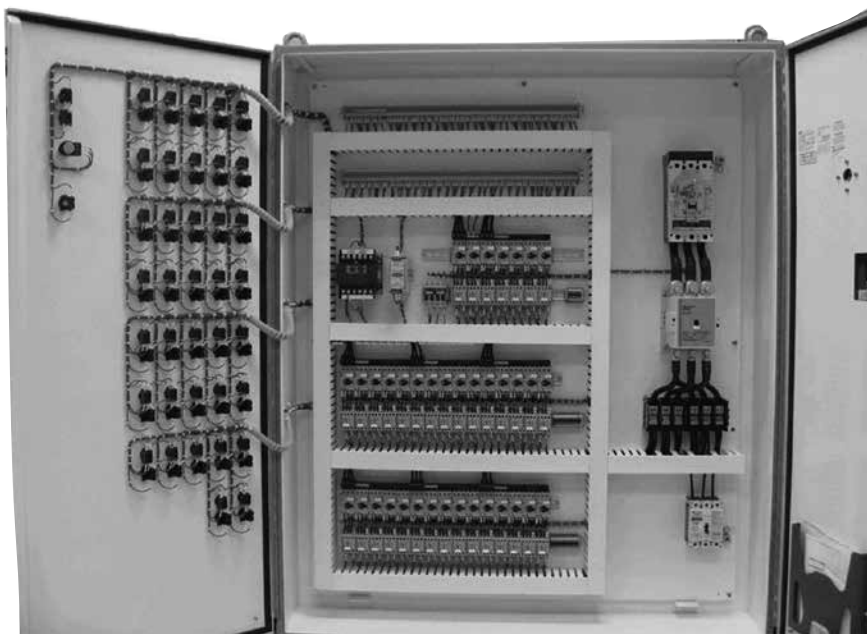

Short Circuit Current Ratings (SSCR)

Short Circuit Current Ratings as defined by UL is a hot topic of discussion within the controls marketplace.

UL 508A Industrial Control Panel specifications require every multiple motor starter panel assembly to be labeled with the Short-Circuit Current Rating (SCCR), which depends on the weakest component's KAIC rating. The SCCR rules are complicated and UL conducts classes around the country on this subject. Sprecher + Schuh conducted a survey of multi-starter panel builders which indicated an increased concern on

the part of panel builders to comply with the UL regulations; yet many do not truly understand the complexity of the rules. This is another reason to consult the experts at Sprecher + Schuh.

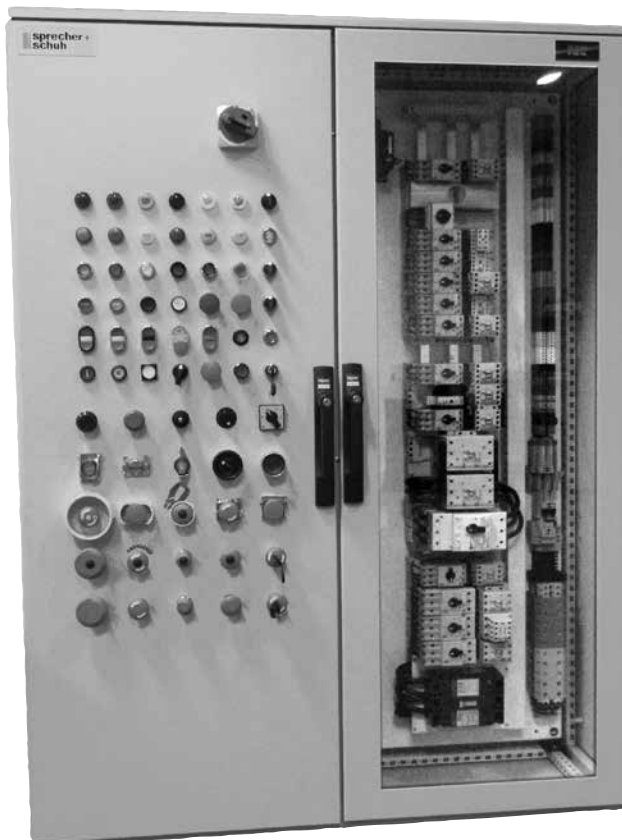

3-Phase 60mm Bus Bar System vertically arranged to maximize space

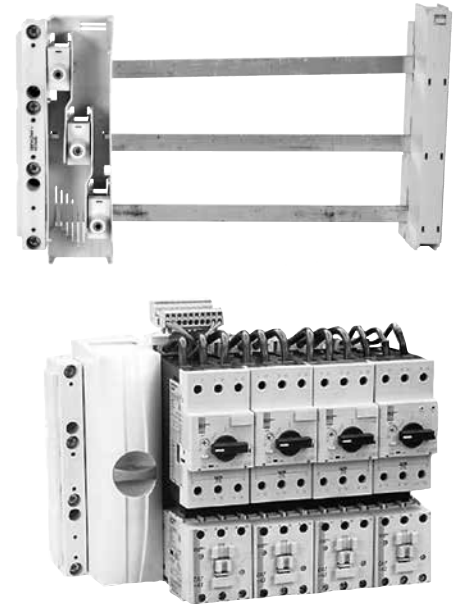

Custom Bus Bar Systems

Sprecher + Schuh has teamed-up with *Wöhner* to supply 3-phase 60 mm bus bar systems. Bus Bar systems offer more flexibility, and a smaller, more economical alternative to a Motor Control Center that uses 'bucket' design.

- Sprecher + Schuh can supply 3-phase 60 mm bus bar components for customer assembly into a control panel.
- We can help design a 3-phase 60 mm bus bar system and provide it with or without components and ship to the customer as open assembly.
- Sprecher + Schuh can help design a 3-phase 60 mm bus bar system and integrate that bus system into an enclosed assembly or multi-starter custom control panel to meet customers' unique specifications.

Please contact your local Sprecher + Schuh Representative or our Technical Support Team to help design our components to meet your needs, which can include building the custom control.

F

Enclosed Motor Circuit Controllers

Single, Two and Three Phase Connection Diagram

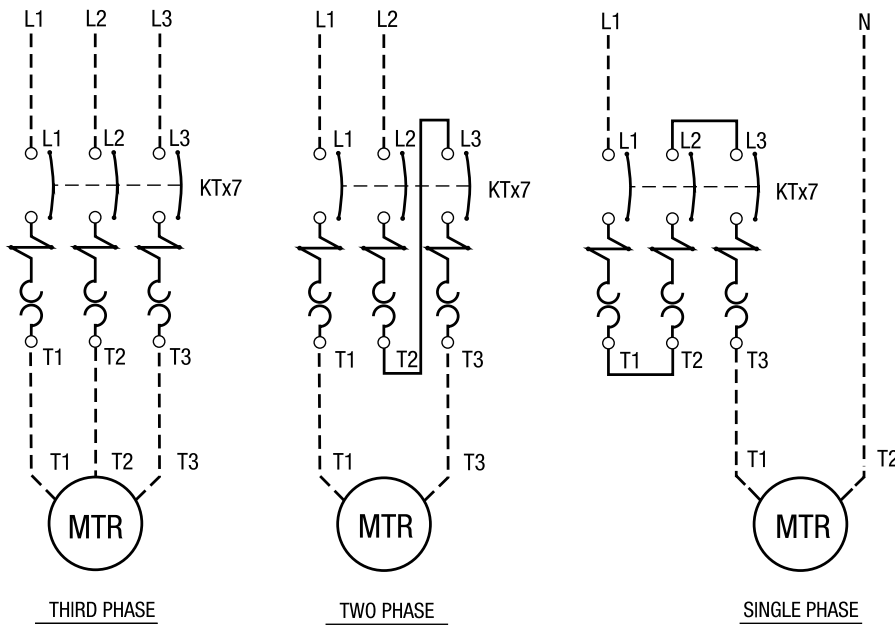

**Type E/F Combination Controller Full Voltage Non-Reversing
AC Control with D7 Series Pilot Devices**

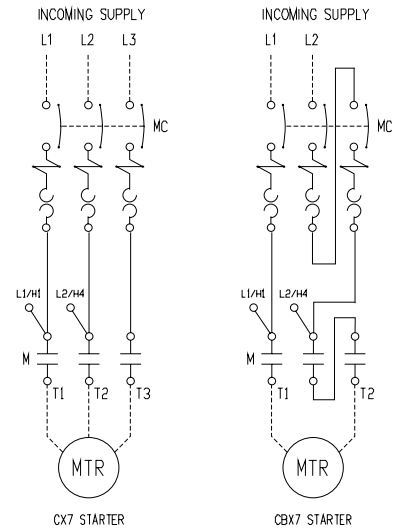
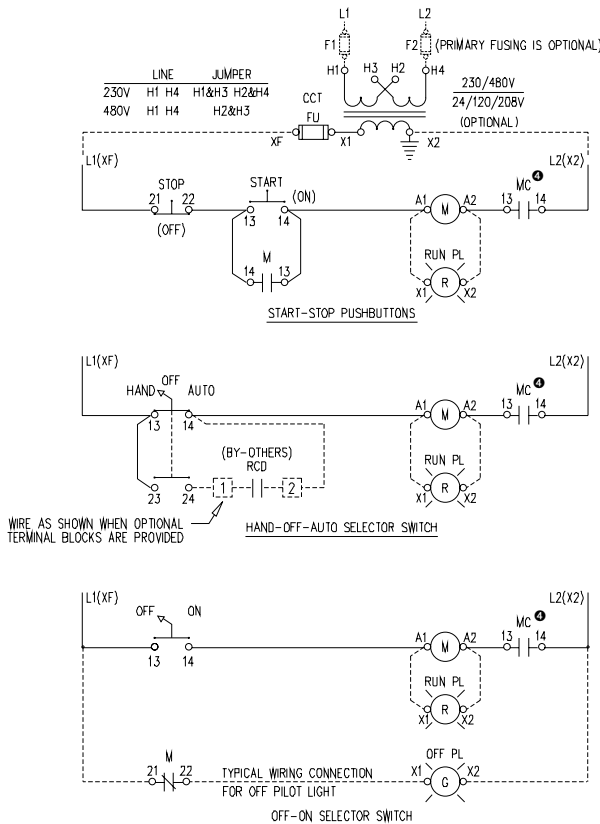

- NOTES:
- 1) RCD: STANDS FOR REMOTE CONTROL DEVICE BY CUSTOMER
 - 2) MC: KT9 TYPE E MOTOR CONTROLLER
 - 3) X2 TERMINAL GROUNDED AS STANDARD, REMOVE GROUND IF NOT REQUIRED
 - 4) TYPICAL FOR CONTROL CIRCUITS 300V AC OR LESS

F

Enclosed Motor Circuit Controllers

KTA9 Type E/F Combination 3-PH FVNR Duplex Alternating Panel with H-O-A, Lead, Lag and Stop 1-Pole Float Switches

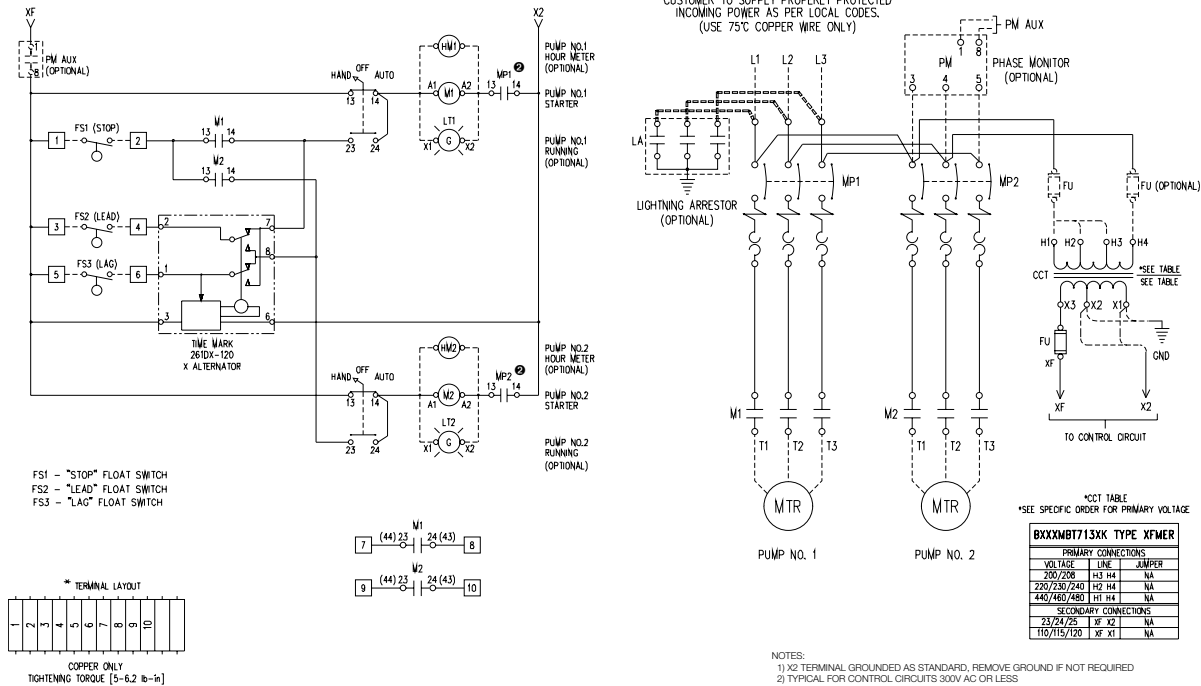

KTA9 Type E/F Combination 3-PH FVNR Duplex Alternating Panel with H-O-A, Alarm Circuit, Lead, Lag, Stop, 1-Pole Float Switches

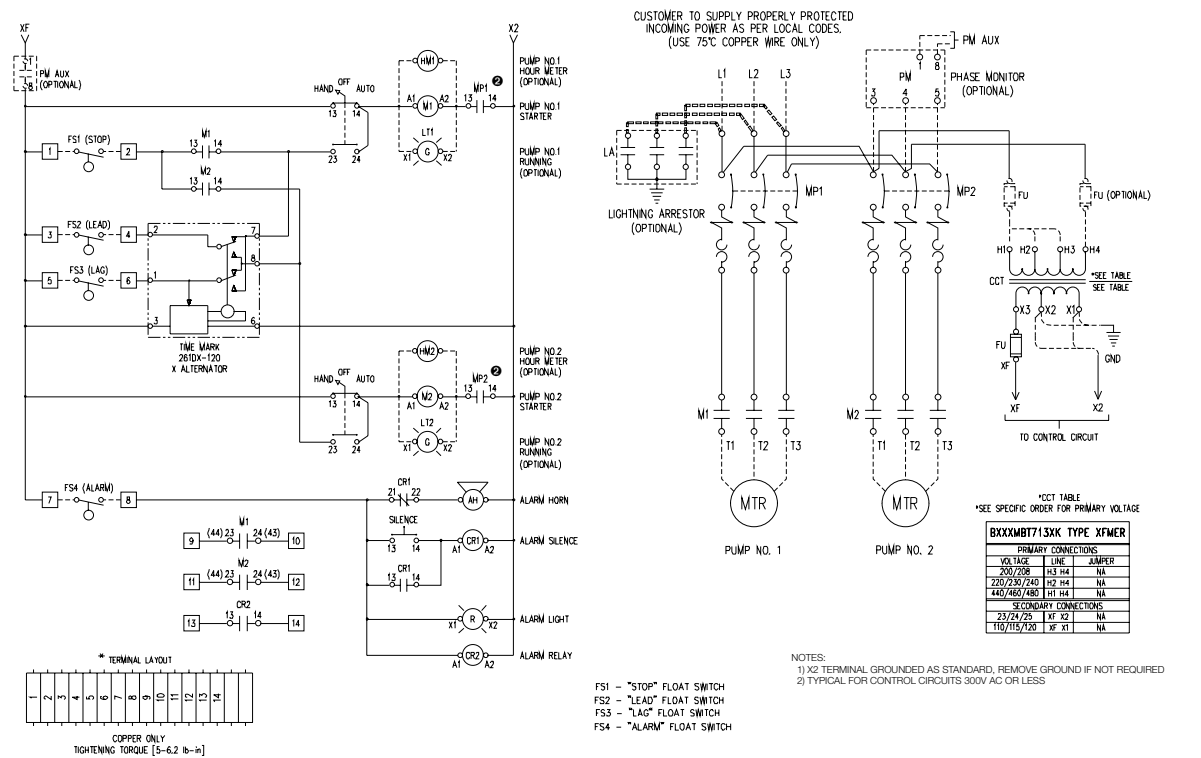

F Enclosed Motor Circuit Controllers

*CCT TABLE
*SEE SPECIFIC ORDER FOR PRIMARY VOLTAGE

BXXXMBT713XK TYPE XFMR			
PRIMARY CONNECTIONS			
VOLTAGE	LINE	JUMPER	
200/208	H3 H4	NA	
230/230/240	H2 H4	NA	
440/460/480	H1 H4	NA	
SECONDARY CONNECTIONS			
23/24/25	X1 X2	NA	
110/115/120	XF X1	NA	

CX7/CXU7 KWIKstarter Enclosure KS7-COC4R (Dimension Code Q4)

Dimensions are in decimal inches. Dimensions not intended for manufacturing purposes.

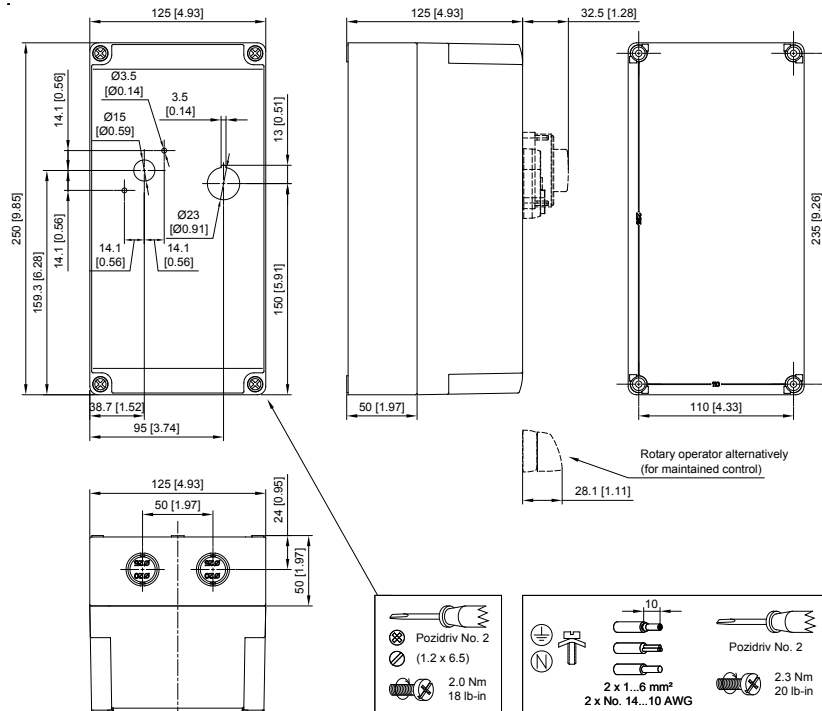

Enclosure Dimensions

Dimensions are in decimal inches. Dimensions not intended for manufacturing purposes. See dimension drawings on next page.

IP65 ENCLOSURE

Encl. ID Dim.	Figure No.	Enclosure Size			Mtg Depth	Mtg Centers			Panel Size Sub-Pan	
		A	B	C		D	E	F		
AY	1	5.91	3.54	5.12	N/A	N/A	5.32	N/A	N/A	

TYPE-4/4X/12 ENCLOSURE

Encl. ID Dim.	Figure No.	Enclosure Size			Mtg Depth	Mtg Centers			Panel Size Sub-Pan	
		A	B	C		D	E	F		
Q5	2	7.00	5.03	5.02	4.3	4.21	6.18	N/A	N/A	
Q6	3	7.00	7.00	6.02	5.3	6.18	6.18	N/A	N/A	
Q7	4	11.87	7.31	10.6	7.23	6.54	11.10	N/A	N/A	

TYPE-4/12 & 12 ENCLOSURES

Encl. ID Dim.	Figure No.	Enclosure Size			Mtg Depth	Mtg Centers			Panel Size Sub-Pan		H
		A	B	C		D	E	F			
W6	5	9.84	7.87	8.24	5.31	5.31	9.13	9.09	7.13	-	
W7	5	13.78	11.81	10.2	7.28	9.25	13.07	13.03	11.06	-	
L	6	8	6	6	5.53	4	8.75	6.75	4.88	9.5	

TYPE 4/7/9 ENCLOSURES

Encl. ID Dim.	Figure No.	Mtg. Dim.			Inside Dim.	Outside Dim.				Conduit Entry Top & Bot
		A	B	C		D	E	F	G	
EX	7	3.25	7.75	3.5	6.0	3.0	4.56	7.06	6.25	0.75
EY	7	5.50	8.50	5.50	5.50	6.0	7.0	7.0	8.84	1.0
EZ	8	9.13	4.50	6.0	8.0	6.63	9.25	11.25	9.34	1.50

Enclosures

See Enclosure Dimension Charts on Previous Page.

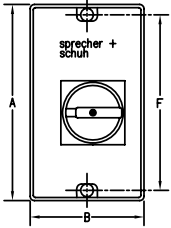

FIGURE NO. 1

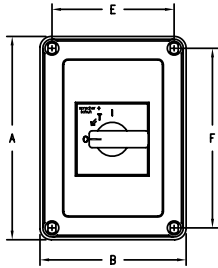

FIGURE NO. 2

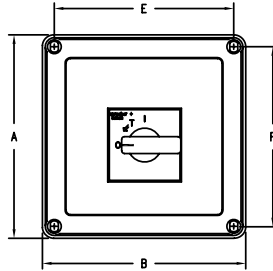

FIGURE NO. 3

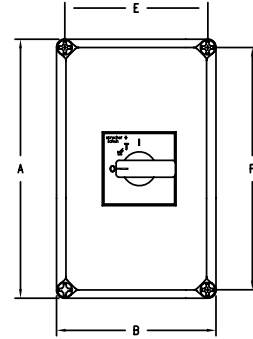
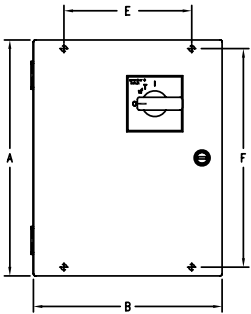
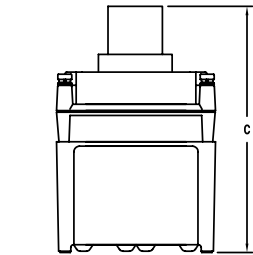
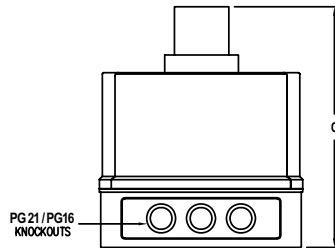
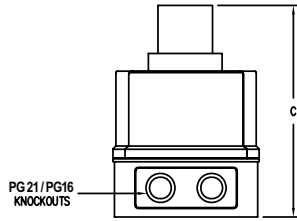
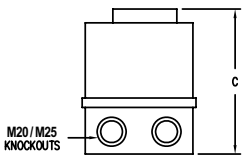
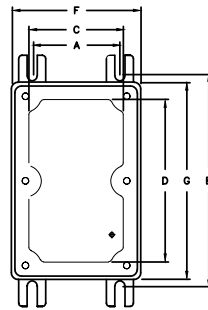
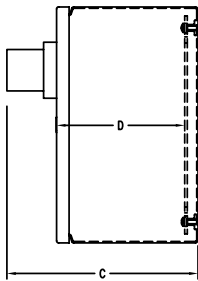

FIGURE NO. 4



TYPE 4/12
FIGURE NO. 5



TYPE 12
FIGURE NO. 6

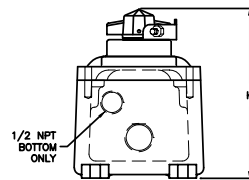
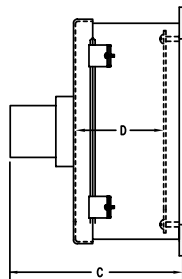
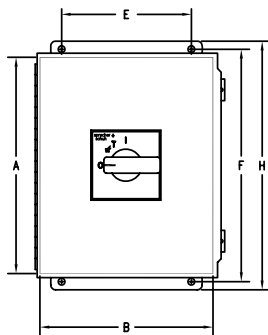

FIGURE NO. 7

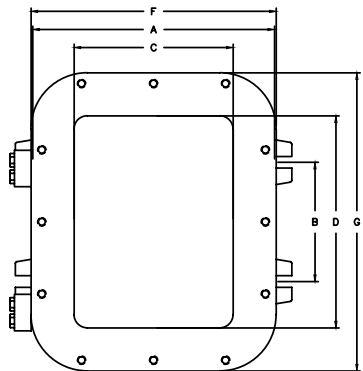
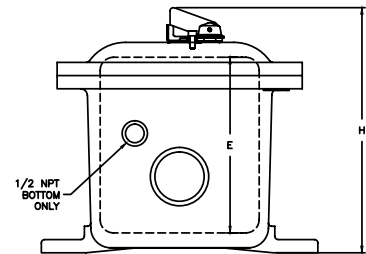

FIGURE NO. 8



F
Enclosed Motor Circuit Controllers

Series KT5 Manual Motor Controllers

Versatile, convenient
and space saving...
for a variety of
applications

Sprecher+Schuh's KT5 Manual Motor Controllers are UL Listed as Manual Motor Controllers with optional approvals for Suitable as Motor Disconnect and Suitable for use in Group Installation.

Group motor installations eliminate the need for individual branch short circuit protective devices for each motor circuit, reducing panel space, installation & wiring time, and costs. There is only one Branch Circuit Protective Device (BCPD) for the "Group".

According to UL 60947-4-1, CSA C22.2 No.60947-4-1, these devices may provide the following control and protection functions.



- Disconnect for Motor Branch Circuit
- Manual Switching (Motor control means)
- Overload Protection (Thermal Protection)



These devices meet requirement of Motor Protective Switching Devices (MPSD) according to IEC 60947-4-1 and Circuit Breaker according to IEC 60947-2 standard for application outside of North America.

These devices provide the following functions.

- Disconnect for Motor Branch Circuit
- Magnetic Short-circuit Protection
- Thermal Overload Protection
- Manual Switching (Motor control means)

KT5 devices provide trip class 10A overload protection and phase loss sensitivity protection. These are suitable for single- and three-phase applications.

Group Installation
Single motor taps must be $\frac{1}{3}$ the ampacity of the branch circuit conductors



Group Installation with MPCBs

There is only one Branch Circuit Protective Device (BCPD) for the "Group". Group installation has been successfully used for many years in the U.S. and Canada. It allows "two motors or one or more motors and other loads to be connected to the same branch-circuit..." The most restrictive part of the conditions specified for Group Installation is the requirement for the protection of the conductors for each motor circuit.

The image below shows an example that illustrates installations involving multiple motors with a single BCPD protecting the entire "Group".

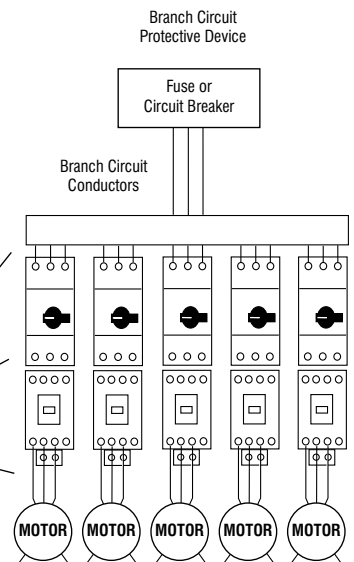

F
KT5 Manual Motor Controllers

KTA5 Manual Motor Controllers

Max. kW, 3-Phase — AC-3 ❶				Typical Three Phase [HP] ❶				Max. Short Circuit Current (kA)		Current Adjustment Range [A]	Magnetic Release Response Current [A]	Catalog Number
230V	400/415V	500V	690V	200V	230V	460V	575V	460V	575V			
~	0.02	0.06	0.06	~	~	~	~	100	30	0.10...0.16	2	KTA5-32A-0.16A
~	0.04	0.09	0.09	~	~	~	~	100	30	0.16...0.25	3.1	KTA5-32A-0.25A
0.06	0.09	0.12	0.18	~	~	~	0.25	100	30	0.25...0.40	5	KTA5-32A-0.4A
0.09	0.18	0.18	0.25	~	~	0.25	0.33	100	30	0.40...0.63	7.9	KTA5-32A-0.63A
0.18	0.25	0.37	0.55	~	~	0.5	0.75	100	30	0.63...1.0	12.5	KTA5-32A-1.0A
0.25	0.55	0.75	1.1	0.25	0.33	1	1	100	30	1.0...1.6	20	KTA5-32A-1.6A
0.37	0.75	1.1	1.8	0.5	0.75	1.5	2	75	30	1.6...2.5	31.3	KTA5-32A-2.5A
0.75	1.5	2.2	3	1	1	~	~	75	18	2.5...4.0	50	KTA5-32A-4.0A
1.5	2.2	3	4	1.5	2	5	5	50	18	4.0...6.3	78.8	KTA5-32A-6.3A
2.2	4	6.3	7.5	3	3	7.5	10	50	18	6.3...10	150	KTA5-32A-10A
3	5.5	6.3	7.5	3	3	7.5	10	50	18	8.0...12	180	KTA5-32A-12A
4	7.5	10	13	5	5	10	15	15	18	10...16	240	KTA5-32A-16A
5.5	10	11	17	5	7.5	15	20	15	18	16...20	300	KTA5-32A-20A
5.5	11	15	22	7.5	7.5	20	20	15	18	20...25	375	KTA5-32A-25A
7.5	15	20	25	7.5	10	25	30	15	18	25...32	480	KTA5-32A-32A

F
KT5 Manual Motor Controllers

Horsepower ratings shown in the table are for reference only. The final selection of the controller depends on the actual motor full load current and service factor.







- For motor with service factor less than 1.15. Use motor nameplate full load current times 0.9 and choose the motor starter with the appropriate current range.
Example: Motor F.L.C. = 4.2A; S.F. = 1.0. – 4.2A x 0.9 = 3.78A.
Select Catalog Number KTA5-32A-4.0A

KTA5 Selection Using Interrupting Rating/Breaking Capacity

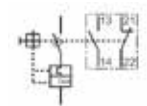
Catalog Number	Breaking Capacity, IEC 60947-2																	
	230V AC			400V AC			440V AC			500V AC			690V AC					
	I _{CS} [kA]	I _{CU} [kA]	Back-up Fuse Rating ❷ [A]	I _{CS} [kA]	I _{CU} [kA]	Back-up Fuse Rating ❷ [A]	I _{CS} [kA]	I _{CU} [kA]	Back-up Fuse Rating ❷ [A]	I _{CS} [kA]	I _{CU} [kA]	Back-up Fuse Rating ❷ [A]	I _{CS} [kA]	I _{CU} [kA]	Back-up Fuse Rating ❷ [A]			
KTA5-32A-0.16A	50	100	~❸	50	100	~❸	30	100	~❸	30	100	~❸	30	100	~❸			
KTA5-32A-0.25A	50	100		50	100		30	100		30	100		30	100		30	100	
KTA5-32A-0.4A	50	100		50	100		30	100		30	100		30	100		30	100	
KTA5-32A-0.63A	50	100		50	100		30	100		30	100		30	100		30	100	
KTA5-32A-1.0A	50	100		50	100		30	100		30	100		30	100		30	100	
KTA5-32A-1.6A	50	100		50	100		30	100		30	100		30	100		30	100	
KTA5-32A-2.5A	50	75		50	75		10	30		25 ❹	10		20	25 ❹		5	10	25 ❹
KTA5-32A-4.0A	50	75		50	75		6	18		25 ❹	6		15	25 ❹		2	3	25 ❹
KTA5-32A-6.3A	50	50		50	50		6	18		63 ❹	6		10	63 ❹		2	3	40 ❹
KTA5-32A-10A	50	50		50	50		6	18		63 ❹	6		10	63 ❹		2	3	50 ❹
KTA5-32A-12A	25	50	80 ❹	25	50	80 ❹	6	15	63 ❹	6	10	63 ❹	2	3	50 ❹			
KTA5-32A-16A	15	15	40 ❹	15	15	40 ❹	4	6	63 ❹	4	6	63 ❹	2	3	63 ❹			
KTA5-32A-20A	10	15	125 ❹	10	15	125 ❹	3	6	125 ❹	3	6	125 ❹	2	3	80 ❹			
KTA5-32A-25A	10	15	125 ❹	10	15	125 ❹	3	6	125 ❹	3	6	125 ❹	2	3	100 ❹			
KTA5-32A-32A	10	15	125 ❹	10	15	125 ❹	3	6	125 ❹	3	6	125 ❹	2	3	100 ❹			

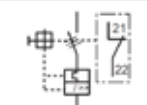
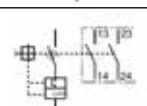

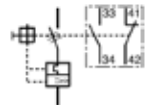
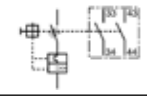
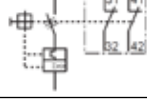
- ❶ Horsepower ratings shown are for reference. The final selection of the controller depends on the actual motor full load current.
- ❷ Back-up fuses are type gG, aM.
- ❸ No back-up fuse required if I_{cc} < I_{cs}.
- ❹ Rated back-up fuse for short-circuit up to 50 kA.

Accessories for KT5

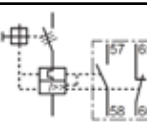

Accessory	Description	Auxiliary		Connection Diagram and Terminal Markings ⌀	For Use With	Pkg Qty	Catalog Number
		N.O	N.C				
	Front mounted Auxiliary Contact • No additional space required • 1 and 2-pole	1	1		KT5	10	KT5-PE1-11
		1	0				KT5-PE1-10
		0	1				KT5-PE1-01
		2	0				KT5-PE1-20
	Right-side-mounted Auxiliary Contact • 2-pole • Adds 9 mm to the width of the Manual Motor Starter • Use compact bus bars with 54 mm spacing	1	1		KT5	2	KT5-PA1-11
		2	0				KT5-PA1-20
		0	2				KT5-PA1-02
		Lead Contacts					KT5-PA1-20L
		2	0				

F KT5 Manual Motor Controllers

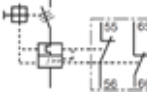

Trip Contacts

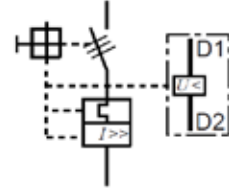
Accessory	Description	Auxiliary Contacts		Connection Diagram and Terminal Markings ⌀	For Use With	Pkg Qty	Catalog Number
		N.O	N.C				
	Right-side-mounted Trip Signaling Contact • 2-pole • Adds 9 mm to the width of the Manual Motor Starter • Use compact bus bars with 54 mm spacing	1	1		KT5	2	KT5-PAF1-S11
		2	0				KT5-PAF1-S20
		0	2				KT5-PAF1-S02

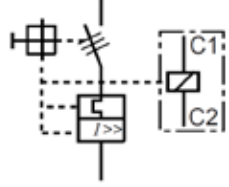

Accessories for KT5

Accessory	Description	Connection Diagram	AC Coil Voltage	Pkg Qty	For Use With	Catalog Number
	Undervoltage Trip Release <ul style="list-style-type: none"> Left-side mounted Adds 18 mm to the width of the Manual Motor Starter 		20V, 50 Hz/ 24V, 60 Hz	1	KT5	KT5-UA-24V
			24V, 50 Hz			KT5-UA-28V
			48V, 50 Hz			KT5-UA-48V
			60V, 50 Hz			KT5-UA-60V
			110V, 50 Hz/ 120V, 60 Hz			KT5-UA-120V
			208V, 60 Hz			KT5-UA-208V
			230V, 50 Hz/ 240V, 60 Hz			KT5-UA-240V
			400V, 50 Hz			KT5-UA-400V
			415V, 50 Hz/ 480V, 60 Hz			KT5-UA-480V
			575V, 60 Hz			KT5-UA-575V
	Shunt Trip Release <ul style="list-style-type: none"> Left-side mounted Adds 18 mm to the width of the Manual Motor Starter 		20-24 V, 50/60 Hz	1	KT5	KT5-AA-24V
			110V, 50/60 Hz			KT5-AA-110V
			200...240V, 50/60 Hz			KT5-AA-240V
			350...415V, 50/60 Hz			KT5-AA-415V

Bus Bars

Accessory	Description	Connection Diagram	Terminal Links	Pkg Qty	For Use With	Catalog Number	
	Compact Bus Bars <ul style="list-style-type: none"> UL: 600V, 60 A IEC: 690V, 65 A 	<ul style="list-style-type: none"> 45 mm spacing For use with front-mounted auxiliary contact 	2 x 3 connections	10	KT5	KT5-32-DB-45-2	
			3 x 3 connections			KT5-32-DB-45-3	
			4 x 3 connections			KT5-32-DB-45-4	
			5 x 3 connections			KT5-32-DB-45-5	
			<ul style="list-style-type: none"> 54 mm spacing For use with side-mounted auxiliary contact 	2 x 3 connections	10	KT5	KT5-32-DB-54-2
				3 x 3 connections			KT5-32-DB-54-3
				4 x 3 connections			KT5-32-DB-54-4
				5 x 3 connections			KT5-32-DB-54-5
			<ul style="list-style-type: none"> 63 mm spacing For use with side-mounted trip release 	2 x 3 connections	10	KT5	KT5-32-DB-63-2
				3 x 3 connections			KT5-32-DB-63-3
				4 x 3 connections			KT5-32-DB-63-4
				5 x 3 connections			KT5-32-DB-63-5
	Bus Bar Feeder Terminal (Flat) <ul style="list-style-type: none"> Supply of compact bus bars Increases terminal capacity 			10	KT5-32-DB	KT5-32-A3N	
	Bus Bar Feeder Terminal (High) <ul style="list-style-type: none"> Supply of compact bus bars Increases terminal capacity 					10	KT5-32-A3NH

Connecting Modules

Accessory	Description	Pkg Qty	For Use With	Catalog Number
	Connecting Module - 12 A <ul style="list-style-type: none"> For DOL Starters Starters mount on single DIN Rail (KT5 on DIN rail) Electrical and mechanical interconnection of KT5 and CA8 Contactors 	1	KT5 to CA8	KT5-32-PEK12
	Connecting Module - 25 A <ul style="list-style-type: none"> For DOL Starters Starters mount on single DIN Rail (KT5 on DIN rail) Electrical and mechanical interconnection of KT5 and CA7 Contactors 	1	KT5 to CA7-9...23	KT5-32-PEC23

Accessories for KT5





Accessory	Description	Color	Legend	For Use with	Pkg Qty	Catalog Number
	Blank Space Cover • For covering unused terminal links • Must be ordered in multiples of 10 (10pcs/pkg)	Gray/Black		KT5	50	KT5-WSN
	Screw Adapter • For screw arrangement of a motor protection circuit breaker • Hat (DIN) Rail 35 x 7.5 mm • 44 mm length	Red/Yellow		KT5	10	KT5-N45
	Enclosure • Up to three padlocks in OFF position • Protection Class: IP65; UL/CSA Type 12	Red/Yellow	0 - I OFF -ON Trip	KT5	1	KT5-ENY65
		Black Handle				KT5-ENN65
	Door Mounting Kit • Up to three padlocks in OFF position • Protection Class: IP65; UL/CSA Type 12	Red/Yellow	0 - I OFF -ON Trip	KT5	1	KT5-DMY65
		Black Handle				KT5-DMN65
	Door Coupling Handle • Up to three padlocks in OFF position • Defeatable	Red/Yellow	0 - I OFF -ON Trip	KT5	1	KT5-HCRY
		Black/Black	0 - I OFF - ON Trip			KT5-HTC
	Coupler • Coded - Positioning of ON indication dependent from mounting orientation of the KT5 • Uncoded - Positioning of ON indication independent from mounting orientation of the KT5	Driver with screw		KT5	1	KT5-DNC
		Driver without coding, with screw				KT5-DNUC
	Shaft Alignment Ring • Supports the long shafts for alignment to the handle inlet. It makes closing panel doors easier • Use for shafts			KT5	1	KT5-SAR
	Extension Shaft	105 mm (4.13 in.)		KT5	10	KT5-HT
		180 mm (7.1 in.)				KT5-HTM
	Extension Shaft Support • Supports the shaft in the extension of handle (KT5-HTC/KT5-HTRY) • Required for shaft lengths > 130 mm (5.1 in.) • Snaps on the right side of the KT5 controller • Width 9 mm. • For use with screw-mounted or hat rail mounted devices.			KT5	1	KT5-SHS
	Lockable Handle Accessory • For locking KT5 devices in the OFF position			KT5	10	KT5-KN

F
KT5 Manual Motor Controllers

Technical Information

Standards Compliance	IEC	IEC/EN 60947-2, IEC/EN 60947-4-1, IEC/EN 60947-1	
	cULus	UL 60947-1, UL 60947-4-1	
Certification	Global	RINA (Marine)	
	Regional	CCC, KC, EAC, CE, IEC, cULus, CB Scheme	
Rated Operating Voltage	IEC [V]	690	
Rated Impulse Withstand Voltage	UL, CSA [V]	600	
	Main Circuits	6kV	
	Auxiliary Circuits	6kV	
Rated Frequency	[Hz]	50...60	
Rated Operating Current	[A]	0.1...32 (15 ranges)	
Number of Operations	Mechanical [operations]	100,000 Cycles	
	Electrical [operations]	100,000 Cycles (0.1...16A); 50,000 Cycles (20...32A)	
Ambient Temperature	Storage	-50...+80°C (-58...+176°F)	
	Operating	Open-compensated	-25...+55°C (-13...+131°F) ❶
		Open	-25...+70°C (-13...+158°F) ❶
		Enclosed	0...+40°C (32...104°F)
Maximum Operating Altitude Permissible		2000m	
Pollution Degree		3	
Phase loss sensitivity		Yes	
Disconnect Function per IEC/60947-2		Yes	
Resistance to shock per IEC 60068-2-27		25g/11ms	
Resistance to vibration per IEC 60068-2-6		5g/3...150Hz	
Minimum distance to other units same type	Horizontal	0 mm (0 in.)	
	Vertical	150 mm (5.9 in.)	
Minimum Distance to Electrical Conductive Bus Bar	Horizontal, up to 400V	0mm (0 in.)	
	Vertical, up to 690V	> 1.5mm (0.06 in.)	
Degree of Protection	Housing	IP20	
	Mwain Terminal	IP10	
Utilization Category	IEC 60947-2 (Circuit breaker)	A	
	IEC 60947-4-1 (Motor Starter)	AC-3	
Power Loss in all three poles up to:	0.16...1.6A	5.1 W	
	2.5...6.3A	5.4 W	
	10...12A	7.2 W	
	16...25A	8.4 W	
	32A	9.3 W	

Terminal Connections

Connection		No. of Conductors	Devices Rated ≤ 16 A	Devices Rated 20...32 A
Type of terminals				
Connection Screw			M3.5/Pozidriv No.2	M4/Pozidriv No.2
Wiring	Solid	 1 or 2	1...4 mm ²	1...2.5 mm ² 2.5...6 mm ²
	Flexible with ferrule	 1 or 2	0.75...2.5 mm ²	0.75...6 mm ²
	Flexible	 1 or 2	0.75...2.5 mm ² / No. 16...12 AWG	1.5...2.5 mm ² / No.16...8 AWG 2.5...6 mm ² / No.16...8 AWG
	Stranded per UL/CSA	 1 or 2	1...4 mm ² / No. 16...12 AWG	1...2.5 mm ² / No.16...8 AWG 2.5...6 mm ² / No.16...8 AWG
	Stripping length		9 mm (0.35 in.)	10 mm (0.39 in.)
Tightening torques			0.8...1.2 N•m / 7...10 lb•in	2 N•m / 18 lb•in

❶ With derating. See UL/CSA Listed Applications ratings table on page F120.7

UL/CSA Listed Application Ratings, Manual Motor Controller Only

Catalog Number	UL 60947-4-1 — Manual Motor Controller				
	Branch Circuit Protection Max. Size per NEC/CEC [A]	Max. Short Circuit Current [kA]			
		Motor Disconnect		Group Installation	
		480V	600V	480V	600V
KTA5-32A-0.16A	175	30	5	30	5
KTA5-32A-0.25A	175	30	5	30	5
KTA5-32A-0.4A	175	30	5	30	5
KTA5-32A-0.63A	175	30	5	30	5
KTA5-32A-1.0A	175	30	5	30	5
KTA5-32A-1.6A	175	30	5	30	5
KTA5-32A-2.5A	175	30	5	30	5
KTA5-32A-4.0A	175	18	5	18	5
KTA5-32A-6.3A	175	18	5	18	5
KTA5-32A-10A	175	18	5	18	5
KTA5-32A-12A	175	18	5	18	5
KTA5-32A-16A	175	18	5	18	5
KTA5-32A-20A	400	18	5	18	5
KTA5-32A-25A	400	18	5	18	5
KTA5-32A-32A	400	18	5	18	5

Application Ratings, KT5 to CA8 Miniature Contactors

Catalog Number	UL 60947-4-1 — Manual Motor Controller					
	Max. Fuse or Circuit Breaker Size per NEC [A]	For Use With Contactor Cat. No.	Max. Short Circuit Current [kA]			
			Motor Disconnect		Group Installation	
			480V	600V	480V	600V
KTA5-32A-0.16A	175	CA8-09	30	5	30	5
KTA5-32A-0.25A	175	CA8-09	30	5	30	5
KTA5-32A-0.4A	175	CA8-09	30	5	30	5
KTA5-32A-0.63A	175	CA8-09	30	5	30	5
KTA5-32A-1.0A	175	CA8-09	30	5	30	5
KTA5-32A-1.6A	175	CA8-09	30	5	30	5
KTA5-32A-2.5A	175	CA8-09	30	5	30	5
KTA5-32A-4.0A	175	CA8-09	18	5	18	5
KTA5-32A-6.3A	175	CA8-12	18	5	18	5
KTA5-32A-10A	175	CA8-12	18	5	18	5
KTA5-32A-12A	175	CA8-12	18	5	18	5
KTA5-32A-16A	175	CA8-12	18	~	18	~

F
KT5 Manual Motor Controllers

Application Ratings, KT5 to CA7 Contactors

Catalog Number	UL 60947-4-1 — Manual Motor Controller					
	Max. Fuse or Circuit Breaker Size per NEC [A]	For Use With Contactor Cat. No.	Max. Short Circuit Current [kA]			
			Motor Disconnect		Group Installation	
			480V	600V	480V	600V
KTA5-32A-0.16A	175	CA7-9	30	5	30	5
KTA5-32A-0.25A	175	CA7-9	30	5	30	5
KTA5-32A-0.4A	175	CA7-9	30	5	30	5
KTA5-32A-0.63A	175	CA7-9	30	5	30	5
KTA5-32A-1.0A	175	CA7-9	30	5	30	5
KTA5-32A-1.6A	175	CA7-9	30	5	30	5
KTA5-32A-2.5A	175	CA7-9	30	5	30	5
KTA5-32A-4.0A	175	CA7-9	18	5	18	5
KTA5-32A-6.3A	175	CA7-9	18	5	18	5
KTA5-32A-10A	175	CA7-9	18	5	18	5
KTA5-32A-12A	175	CA7-12	18	5	18	5
KTA5-32A-16A	175	CA7-16	18	5	18	5
KTA5-32A-20A	400	CA7-23	18	5	18	5
KTA5-32A-25A	400	CA7-30	18	5	18	5
KTA5-32A-32A	400	CA7-30	18	5	18	5

Type 2 Coordination Ratings, KT5 to CA7 Contactors, Standard Motor Protection

Catalog Number	IEC 60947-4-1		UL 60947-4-1					
	400/415V		480V			600V		
	Max. Short Circuit Current [kA]	For Use With Contactor Cat. No.	Max. Fuse or Circuit Breaker Size per NEC [A]	Max. Short Circuit Current [kA]	For Use With Contactor Cat. No.	Max. Fuse or Circuit Breaker Size per NEC [A]	Max. Short Circuit Current [kA]	For Use With Contactor Cat. No.
KTA5-32A-0.16A	50	CA7-9	175	30	CA7-9	175	5	CA7-9
KTA5-32A-0.25A	50	CA7-9	175	30	CA7-9	175	5	CA7-9
KTA5-32A-0.4A	50	CA7-9	175	30	CA7-9	175	5	CA7-9
KTA5-32A-0.63A	50	CA7-9	175	30	CA7-9	175	5	CA7-9
KTA5-32A-1.0A	50	CA7-9	175	30	CA7-9	175	5	CA7-9
KTA5-32A-1.6A	50	CA7-9	175	30	CA7-9	175	5	CA7-9
KTA5-32A-2.5A	50	CA7-9	175	30	CA7-12	175	5	CA7-12
KTA5-32A-4.0A	50	CA7-9	175	18	CA7-23	175	5	CA7-23
KTA5-32A-6.3A	50	CA7-9	175	18	CA7-23	175	5	CA7-23
KTA5-32A-10A	50	CA7-9	175	18	CA7-30	175	5	CA7-30
KTA5-32A-12A	25	CA7-12	175	18	CA7-30	175	5	CA7-30
KTA5-32A-16A	16	CA7-23	175	18	CA7-30	175	5	CA7-30
KTA5-32A-20A	10	CA7-30	400	18	CA7-30	400	5	CA7-30
KTA5-32A-25A	10	CA7-30	400	18	CA7-30	400	5	CA7-30
KTA5-32A-32A	10	CA7-30	400	18	CA7-30	400	5	CA7-30

Auxiliary Contact, Signaling Contact, and Short-circuit Signaling Contact Specifications

Specifications of Accessories		KT5-PA... Side-mounted Auxiliary, Signaling, and Short-circuit Signaling Contacts	KT5-PE... Front-mounted Auxiliary Contacts
Standards Compliance	IEC	IEC/EN 60947-1, IEC/EN 60947-5-1	IEC/EN 60947-1, IEC/EN 60947-5-1
	UL/cULus	UL 60947-4-1, CAN/CSA22.2 No. 60947-4-1	UL 60947-4-1, CAN/CSA22.2 No. 60947-4-1
Rated Operating Voltage	[U _e]	690V AC/600V DC	250V AC / 250V DC
Rated Thermal Current	[I _{th}]	6 A	5 A
Rated Frequency	[Hz]	50...60	50...60
Rated Impulse withstand Voltage	[U _{imp}]	6 kV	6 kV
Rated insulation voltage	[U _i]	690 V AC	250 V AC
Pollution Degree		3	3
Ambient Temperature	Operation	-25... +60 °C (-13... +140 °F)	-25... +60 °C (-13... +140 °F)
	Storage	-50... +80 °C (-58... +176 °F)	-50... +80 °C (-58... +176 °F)
Resistance to shock per IEC 60068-2-27		25g / 11 ms	25g / 11 ms
Resistance to vibrations per IEC 60068-2-6		5g / 3...150 Hz	5g / 3...150 Hz
Rated operational current I_e AC-15 per IEC/EN 60947-5-1 for utilization category	24 V, 120 V	6 A	3 A
	240 V	4 A	1.5 A
	400 V	3 A	~
	440 V, 690 V	1 A	~
Rated operational current I_e DC-13 per IEC/EN 60947-5-1 for utilization category	24 V	2 A	1 A
	125 V	0.55 A	250 V 0.27 A
	250 V	0.27 A	0.11 A
	440 V, 600 V	0.15 A	~
Minimum switching capacity		17 V DC / 5 mA	17V DC / 5 mA
Short-circuit protective device (N.O, N.C)		10 A Type gG	10 A Type gG
Duty time		100 %	100 %
Mounting		Right side	Front
Number of operations	Mechanical	50,000 cycles	50,000 cycles
	Electrical		
Contact utilization characteristics according to UL/CSA			
Rated operating voltage U_e per UL/CSA		600 V AC / 600 V DC	250V AC / 250V DC
Pilot duty		B600, Q600	B300, R300
AC thermal rated current		5A	5 A
AC maximum volt-ampere	making	3600	3600 VA
	breaking	360	360 VA
DC thermal rated current		2.5 A	2.5 A
DC maximum volt-ampere	making	69 VA	28 VA
	breaking		





Undervoltage Release Specifications

Attribute		Value
Standards compliance	IEC	IEC/EN 60947-1, IEC/EN 60947-5-1
	UL/cULus	UL 60947-4-1, CAN/CSA22.2 No. 60947-4-1
Rated control supply voltage		See Catalog page F120.4
Rated frequency		
Operating voltage	Tripping	$0.35 \dots 0.7 \times U_s$
	Coil	$0.85 \dots 1.1 \times U_s$
Rated impulse withstand voltage	[U _{imp}]	6 kV
Rated insulation voltage	[U _i]	690V
Pollution degree		3
Ambient air temperature	Operation	-25...+60 °C (-13...+140 °F)
	Storage	-50...+80 °C (-58...+176 °F)
Resistance to shock per IEC 60068-2-27		25g / 11 ms
Resistance to vibrations per IEC 60068-2-6		5g / 3...150 Hz
Mounting		left side of Manual Motor Controller

Shunt Trip Specifications

Attribute		Value
Standards compliance	IEC	IEC/EN 60947-1, IEC/EN 60947-5-1
	UL/cULus	UL 60947-4-1, CAN/CSA22.2 No. 60947-4-1
Rated control supply voltage		See Catalog page F120.4
Rated frequency		
Operating voltage	Tripping	$0.7 \dots 1.1 \times U_s$
Rated impulse withstand voltage	[U _{imp}]	6 kV
Rated insulation voltage	[U _i]	690V
Pollution degree		3
Ambient air temperature	Operation	-25...+60 °C (-13...+140 °F)
	Storage	-50...+80 °C (-58...+176 °F)
Resistance to shock per IEC 60068-2-27		15g/11ms
Resistance to vibrations per IEC 60068-2-6		5g / 3...150 Hz
Mounting		left side of Manual Motor Controller

Terminal Connections





Connection		No. of Conductors	Side Mounted	Front Mounted	
Wiring	Solid		1 or 2	1...1.5 mm ²	1...2.5 mm ²
	Flexible with ferrule		1 or 2	0.75...1.5 mm ²	
	Flexible		1 or 2	0.75...1.5 mm ²	
	Stranded per UL/CSA		1 or 2	No. 16...14 AWG	
	Stripping length			8 mm (0.31 in.)	
Tightening torques			0.8...1.2 N•m / 7lb•in		
Recommended screwdriver			PoziDriv No.2		

IEC Performance Data

Feeder Terminal and Bus Bar Current Ratings

Attribute	KT5-32-DB-45..., -54..., -63...	KT5-32-A3N...
Rated operational voltage	U _e 690 V	690 V
	U _e per UL/CSA 600V AC	600V AC
Rated operational current	I _e 65 A	65 A
	U _e per UL/CSA 60 A	65 A
Suitable for enclosure size	(UL) 200% of Size of KT5 with bus bars	200% of Size of KT5 with bus bars
Rated frequency	50/60 Hz	50/60 Hz
Rated impulse withstand voltage	U _{imp} 6 kV	6 kV
Rated insulation voltage	U _i 690V AC	690V AC

Main Circuit Connecting Characteristics

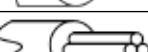
Connection	No. of Conductors	Value	
Wiring	Solid 	1	6...25 mm ²
	Flexible with ferrule 	1	6...16 mm ²
	Flexible with insulated ferrule 	1	6...16 mm ²
	Flexible 	1	6...16 mm ²
	Stranded per UL/CSA 	1	No. 10...4 AWG
	Stripping length		10 mm (0.39 in.)
Tightening torques		2.5 N•m / 22 lb•in	
Recommended screwdriver		Pozidriv No.2	

Weights

Description	Catalog Number	Weight	Description	Catalog Number	Weight	Description	Catalog Number	Weight
Motor Controllers	KTA5-32A-0.16A	246 g	Undervoltage Trip	KT5-AA-24V	110 g	Blank space cover	KT5-WSN	4 g
	KTA5-32A-0.25A			KT5-AA-110V		Screw adapter	KT5-N45	2 g
	KTA5-32A-0.4A			KT5-AA-240V		Lockable handle	KT5-KN	6 g
	KTA5-32A-0.63A			KT5-AA-415V		Enclosure	KT5-ENY65	428 g
	KTA5-32A-1.0A			KT5-UA-24V		KT5-ENN65	435 g	
	KTA5-32A-1.6A		KT5-UA-28V	Door mounting kit	KT5-DMY65	258 g		
	KTA5-32A-2.5A	KT5-UA-48V	KT5-DMN65	268 g				
	KTA5-32A-4.0A	KT5-UA-60V	Door coupling handle	KT5-HCRY	78 g			
	KTA5-32A-6.3A	KT5-UA-120V		KT5-HTC	80 g			
	KTA5-32A-10A	KT5-UA-208V	Extension shaft	KT5-HT	28 g			
	KTA5-32A-12A	KT5-UA-240V	KT5-HTM	50 g				
	KTA5-32A-16A	KT5-UA-400V	Coupler	KT5-DNC	17 g			
	KTA5-32A-20A	KT5-UA-480V	KT5-DNUC	4 g				
	KTA5-32A-25A	KT5-UA-575V	Shaft alignment ring	KT5-SAR	22 g			
KTA5-32A-32A	KT5-32-DB-45-2	37 g	Extension shaft support	KT5-SHS	50 g			
Auxiliary contacts - internal mount	KT5-PE1-11	20 g	Bus Bar connections	KT5-32-DB-45-3	58 g	Connecting module	KT5-32-PEC23	23 g
	KT5-PE1-10	16 g		KT5-32-DB-45-4	81 g			
	KT5-PE1-01	16 g		KT5-32-DB-45-5	103 g			
	KT5-PE1-20	20 g		KT5-32-DB-45-2	39 g			
Auxiliary contacts - side mount	KT5-PA1-11	80 g		KT5-32-DB-54-2	39 g			
	KT5-PA1-20			KT5-32-DB-54-3	60 g			
	KT5-PA1-02			KT5-32-DB-54-4	90 g			
	KT5-PA1-20L			KT5-32-DB-54-5	113 g			
Trip contacts - side mount	KT5-PAF1-S11	80 g		KT5-32-DB-63-2	43 g			
	KT5-PAF1-S20			KT5-32-DB-63-3	70 g			
	KT5-PAF1-S02			41 g	KT5-32-DB-63-4	94 g		
				KT5-32-DB-63-5	123 g			
				KT5-32-A3N	41 g			
				KT5-32-A3NH	51 g			

KT5 Wiring Example

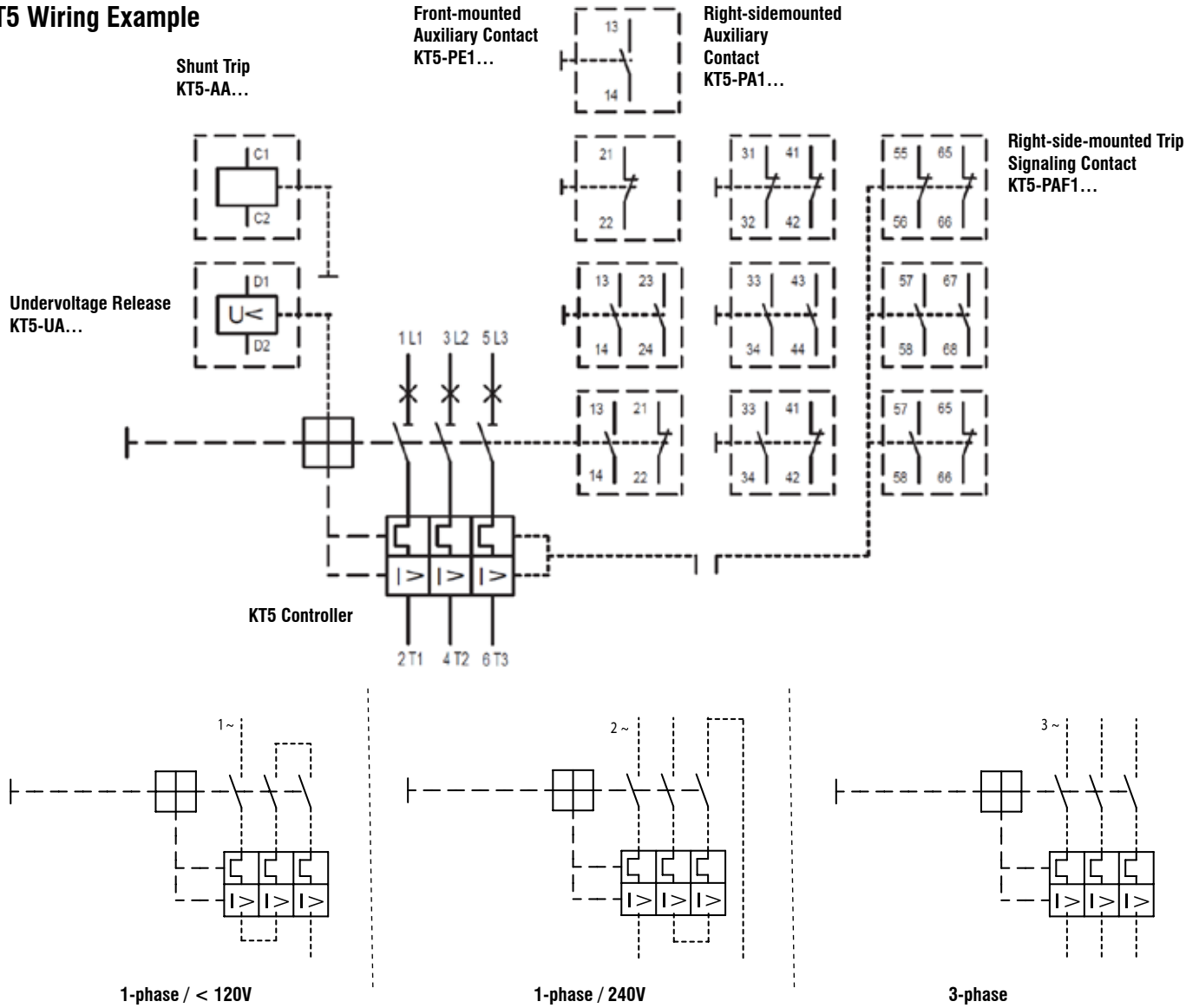

KT5 Mounting Position

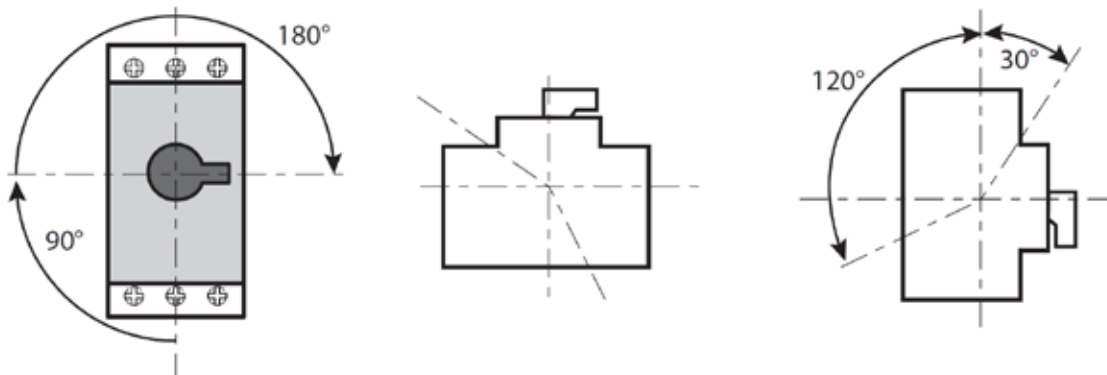

● No backup fuse required.

KTA5-32A-0.16A...16A Manual Motor Controller

Dimensions are in millimeters (inches). Dimensions not intended for manufacturing purposes.

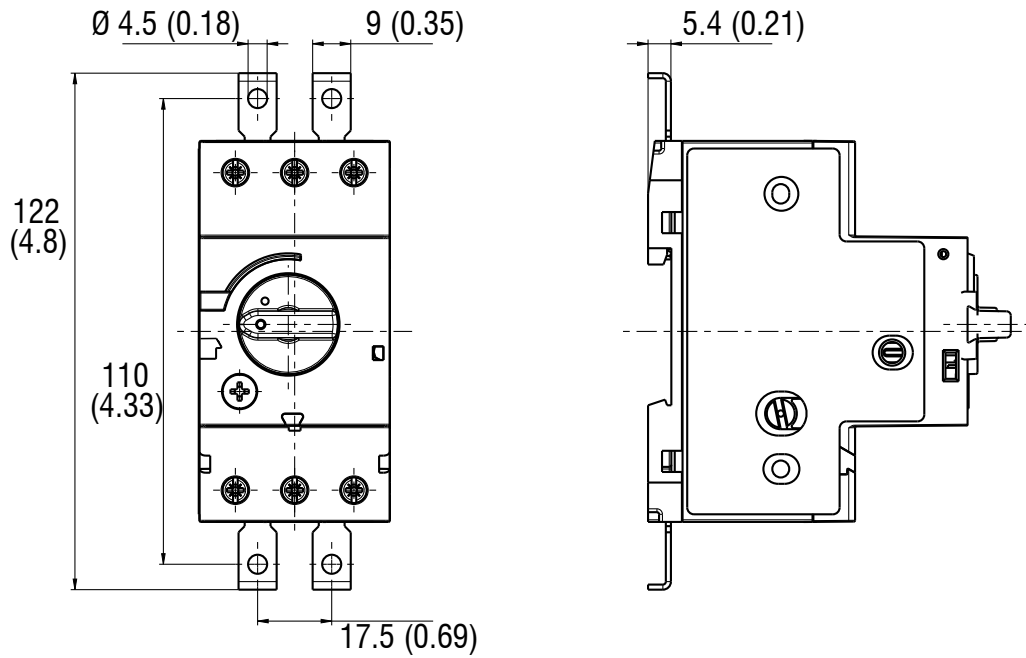

KTA5-32A-0.16A...16A Manual Motor Controller (with Accessories)

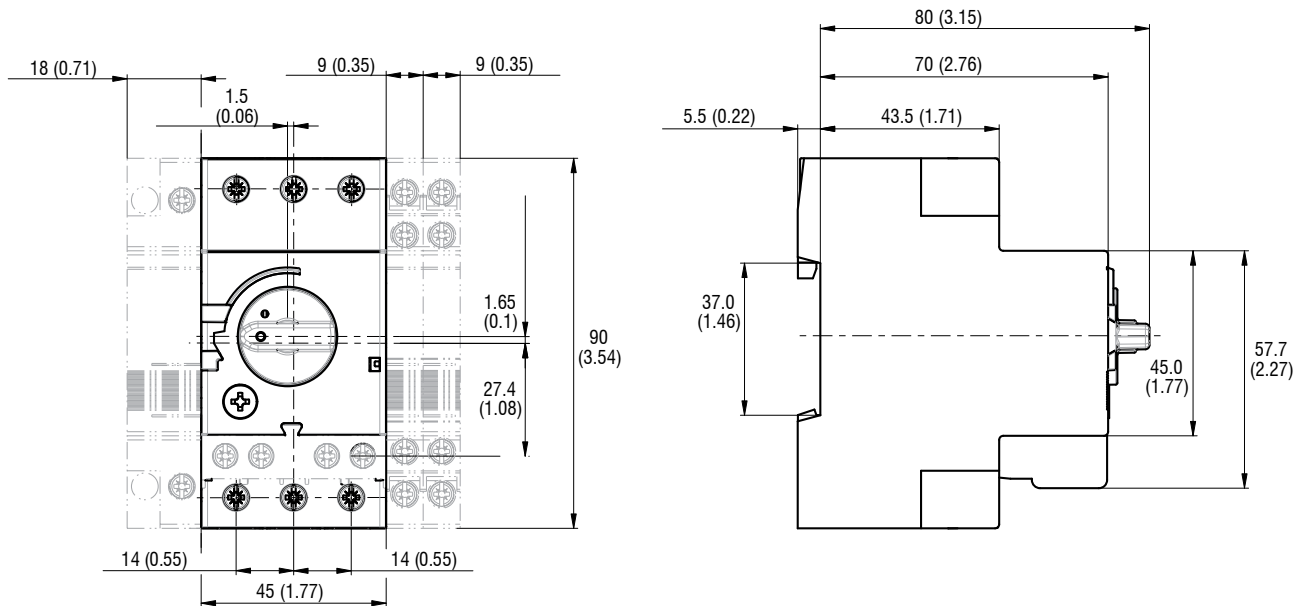

F
KT5 Manual Motor Controllers

KTA5-32A-20A...32A Manual Motor Controller

Dimensions are in millimeters (inches). Dimensions not intended for manufacturing purposes.

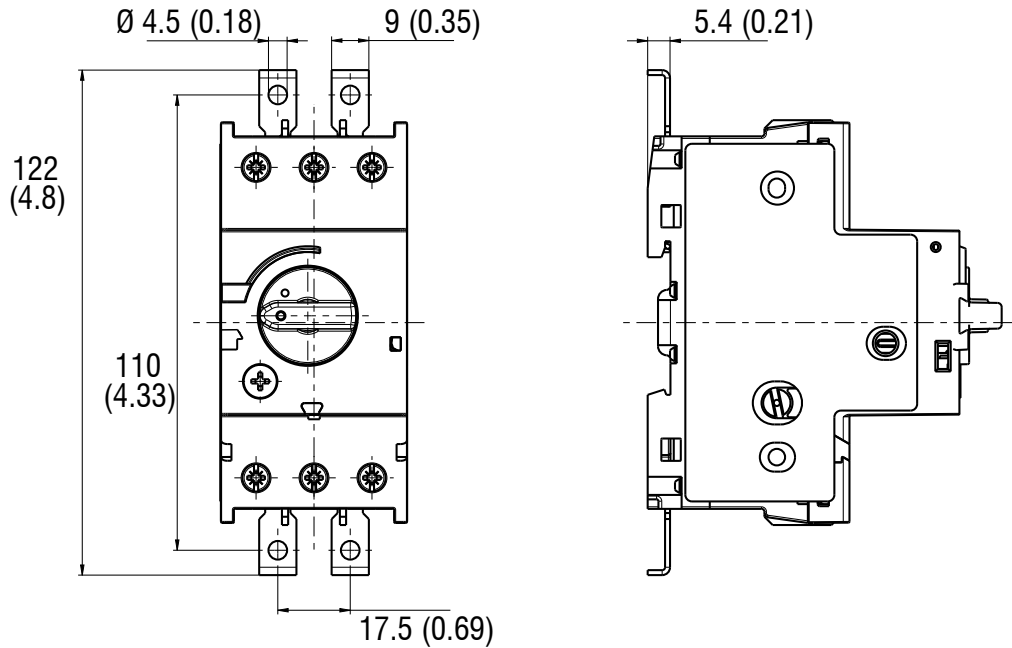

KTA5-32A-20A...32A Manual Motor Controller (with Accessories)

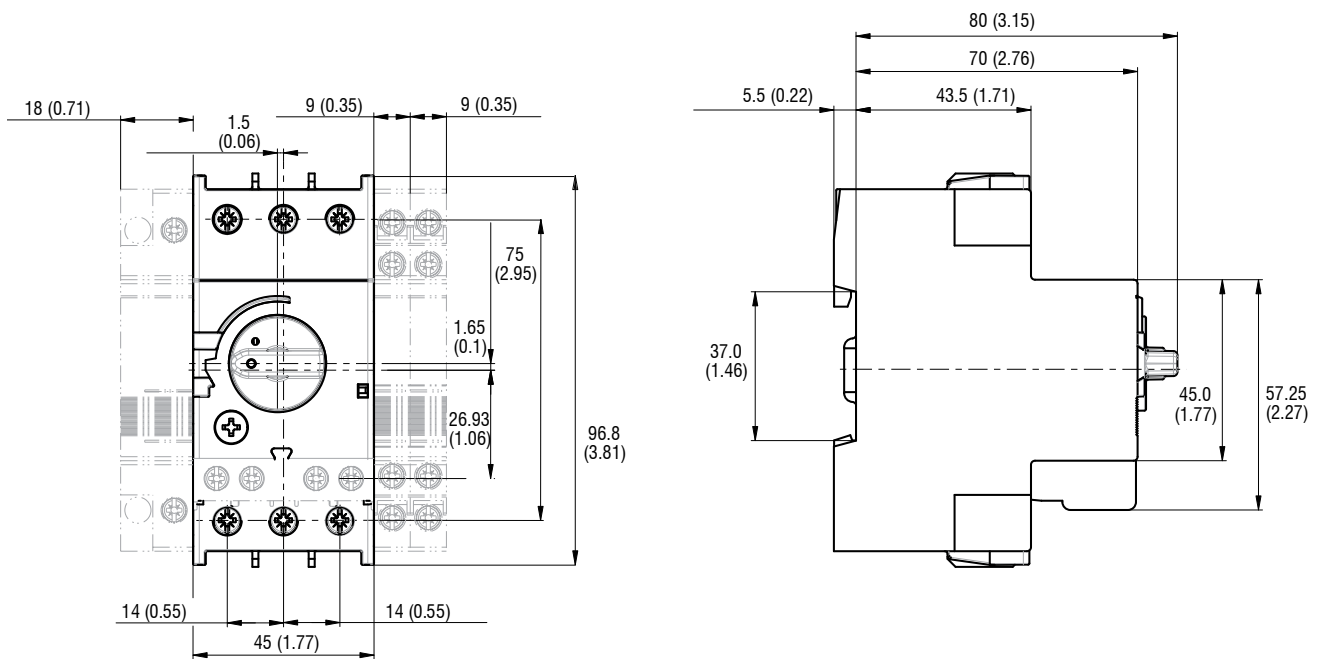

F
 KT5 Manual Motor Controllers

Series KT7 Motor Circuit Controllers

DISCONTINUED

Versatile, convenient
and space saving...
for a variety of
applications

Sprecher+Schuh's KT7 series of Motor Circuit Controllers are some of the most versatile and technologically advanced control products available today.

In one small package, KT7s combine the functions of:

- Current limiting short circuit protection
- Class 10 thermal overload protection
- Switching and
- Signaling

These devices can be used in a wide variety of control schemes that reduce panel space, simplify installation and eliminate the need for more expensive equipment.

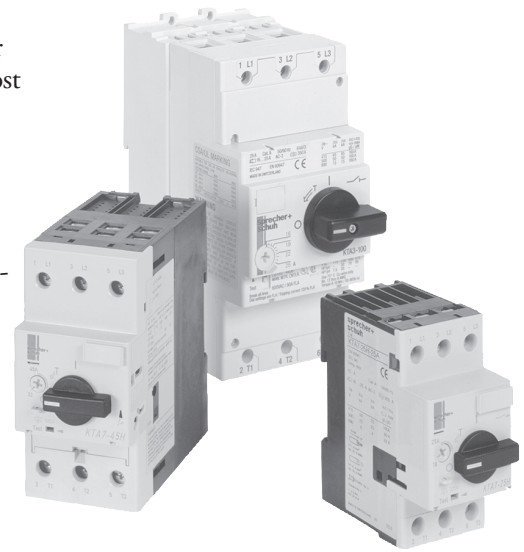

Designed for multiple applications

UL rules allow KT7 Motor Circuit Controllers to be used in a wide variety of applications including:

- Manual Starter Applications
- Traditional Group Motor Applications with compliance to the Tap Conductor Ratings
- Motor Disconnect Applications
- Self-Protected Manual Combination Starter Applications (Type E)
- Individual Combination Starter Applications (Type E/F)
- Multi-motor Starter Combination Applications (Type E/F)

Increased ratings...

Sprecher+Schuh's KT7 controller family offers higher interrupting capacities (KAIC ratings) and improved Type 2 Coordination and Type E (life after short-circuit). The KTA7-25H/32H offers the option of higher short-circuit current ratings (SCCR) than the standard interrupting capacity of the KTA7-25S/32S Motor Controllers. KTA7 is also available in frames up to 45A. KTC7 can be used with High Efficiency motors. KTB7 Magnetic Only controllers can be combined with CA7 contactors and CEP7 overloads to provide additional features. KTV7 series motor controllers are suitable for application at the output of variable frequency drive (VFD) in multi-motor installations.



F
Motor Circuit Controllers

See our online white paper

Methods of Applying

KT7

Motor Circuit Controllers



45mm
(≈ 1 3/4")

25...32A
Standard Interrupting Capacity



45mm
(≈ 1 3/4")

25...32A
High Interrupting Capacity



54mm
(≈ 2 1/8")

45A
High Interrupting Capacity

Construction Type E Listing

Advanced current limiting and breaking capacity has allowed KT7s to be UL / CSA listed as self-protected (Construction Type E) manual combination motor controllers. This eliminates the need for an upstream fuse or circuit breaker when using the KT7 as a manual motor starter. In addition, KT7s also meet

DISCONTINUED

UL requirements for “at-motor disconnects,” which means they can be used in an enclosure with a lockable handle as a manual motor starter for individual circuits, and are also an approved means of motor disconnect.

Type E + Combo starter + Economy = “Ecombo” starter

When the KT7 self-protected manual combination starter is combined with Sprecher + Schuh’s CA7 contactor to provide remote operation, we now have an alternative to the classic combination starter. We call these “Ecombo” starters, which save significant dollars and panel space over conventional combo starters. Ecombo starters are available for applications up to 45 Amperes (30 HP @ 460V).

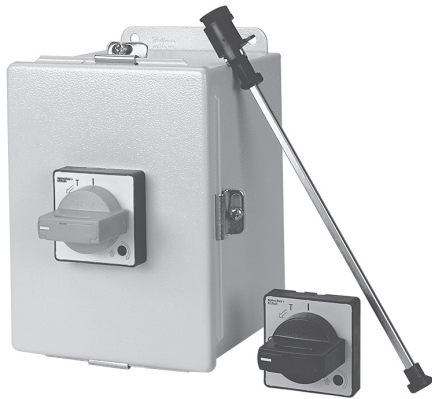

KT7s meet UL requirements for Type E manual motor controllers and “at-motor disconnects”

See a complete explanation of Ecombo starters beginning on page F58 of this catalog.

Multi-motor applications... Popular and money saving

Because of the KT7’s Construction Type E – UL Rating as a self-protected combination starter, many group motor installations can utilize an even simpler design and less expensive equipment. The result is minimum panel size and maximum flexibility while avoiding cumbersome NEC group motor installation rules.

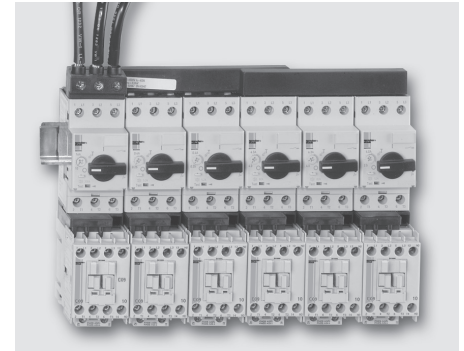

Using KT7s in Multi-Motor Starter applications can replace classic Branch Circuit Protection Devices and reduce panel space up to 60%

Excellent short circuit protection characteristics

In the event of a short-circuit, the contacts are opened by magnetic, non-adjusting tripping elements in times approaching 2/1000 of a second. This results in the extremely rapid buildup of an arc voltage which limits the current of the short-circuit to a very low level. Because of this superb current limiting capability, KTA Motor Circuit Controllers have a short circuit capacity of up to 65kA at 480Y/277V and up to 47kA at 600Y/347V (see illustration below).

Superb thermal overload protection

Every KT7 device is individually calibrated at the factory for the smallest and largest current it can handle. When coupled with automatic ambient temperature compensation over a range of -25°C to +60°C, very accurate thermal overload protection is obtained. In addition, the KT7 is a Class 10 device... it trips within 10 seconds under locked rotor conditions (6 x FLA). This better protects today’s T-Frame motors.

Only model is available *without* the thermal trip feature for special applications where a separate motor overload is required.

Other protection features

All KT7 Motor Circuit Controllers provide accelerated tripping under single phase conditions. This is accomplished with a special “differential tripping” mechanism built into each device.

Special units for special applications

KTC7 controllers are available with a fixed magnetic trip set at 16...20x the maximum value of the current adjustment range (as opposed to 13x for the KTA7). This prevents nuisance tripping in applications utilizing high efficiency motors for example. The KTB7 Magnetic

Manual Motor Starter Ratings

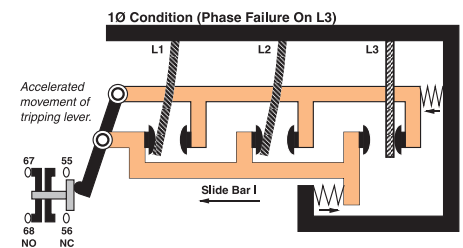
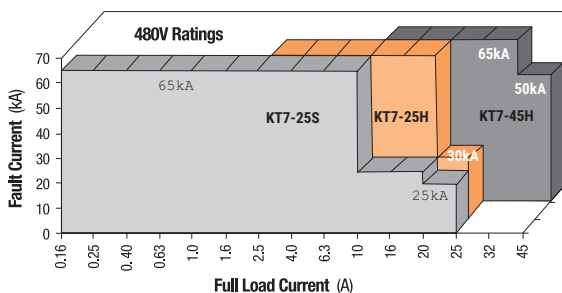

All KT7 Motor Circuit Controllers offer accelerated tripping under single phase conditions

F KT7 Motor Circuit Controllers

KTA7 Base Unit

Maximum Horsepower						Current Adjustment Range [A]	Magnetic Release Response Current [A]	Catalog Number
Typical Single Phase		Typical Three Phase [HP]						
115V	230V	200V	230V	460V	575V			
KTA7-25...32S — Standard Interrupting Capacity								
~	~	~	~	~	~	0.10...0.16	2.1	KTA7-25S-0.16A
~	~	~	~	~	~	0.16...0.25	3.3	KTA7-25S-0.25A
~	~	~	~	~	1/4	0.25...0.40	5.2	KTA7-25S-0.4A
~	~	~	~	1/4	1/3	0.40...0.63	8.2	KTA7-25S-0.63A
~	~	~	~	1/2	3/4	0.63...1.0	13	KTA7-25S-1A
~	1/10	1/4	1/3	1	1	1.0...1.6	21	KTA7-25S-1.6A
1/10	1/6	1/2	3/4	1-1/2	2	1.6...2.5	33	KTA7-25S-2.5A
1/8	1/3	1	1	3	3	2.5...4	52	KTA7-25S-4A
1/4	3/4	1-1/2	2	5	5	4...6.3	82	KTA7-25S-6.3A
1/2	1-1/2	3	3	7-1/2	10	6.3...10	130	KTA7-25S-10A
1	3	5	5	10	15	10...16	208	KTA7-25S-16A
1-1/2	3	5	7-1/2	15	20	14.5...20	260	KTA7-25S-20A
2	3	7-1/2	7-1/2	20	20	18...25	325	KTA7-25S-25A
2	5	7-1/2	10	20	25	24...29	406	KTA7-32S-29A
3	5	7-1/2	10	25	30	27...32	448	KTA7-32S-32A
KTA7-25...32H — High Interrupting Capacity								
1/10	1/6	1/2	3/4	1-1/2	2	1.6...2.5	33	KTA7-25H-2.5A
1/8	1/3	1	1	3	3	2.5...4	52	KTA7-25H-4A
1/4	1/2	1-1/2	2	5	5	4...6.3	82	KTA7-25H-6.3A
1/2	1-1/2	3	3	7-1/2	10	6.3...10	130	KTA7-25H-10A
1	3	5	5	10	15	10...16	208	KTA7-25H-16A
1-1/2	3	5	7-1/2	15	20	14.5...20	260	KTA7-25H-20A
2	3	7-1/2	7-1/2	20	20	18...25	325	KTA7-25H-25A
2	5	7-1/2	10	20	25	24...29	406	KTA7-32H-29A
3	5	7-1/2	10	25	30	27...32	448	KTA7-32H-32A
KTA7-45H — High Interrupting Capacity								
1/2	1-1/2	3	3	7-1/2	7-1/2	6.3...10	130	KTA7-45H-10A
1	3	5	5	10	10	10...16	208	KTA7-45H-16A
1-1/2	3	5	7-1/2	15	15	14.5...20	260	KTA7-45H-20A
2	3	7-1/2	10	20	20	18...25	325	KTA7-45H-25A
3	5	7-1/2	10	25	30	23...32	416	KTA7-45H-32A
3	7-1/2	10	15	30	40	32...45	585	KTA7-45H-45A



Catalog Number KTA7-25S



Catalog Number KTA7-25H



Catalog Number KTA7-45H

F KTT Motor Circuit Controllers

Horsepower ratings shown in the table are for reference only. The final selection of the controller depends on the actual motor full load current and service factor.

- For motor with service factor less than 1.15. Use motor nameplate full load current times 0.9 and choose the motor starter with the appropriate current range. Example: Motor F.L.C. = 4.2A; S.F. = 1.0. – 4.2A x 0.9 = 3.78A. Select Catalog Number KTA7-25S-4A.

KTA7 UL Ratings Application Chart

Device	Manual Motor Starter		Manual Controller for Group Installation ❶		Manual Controller as Motor Disconnect ❷❸		Suitable for Tap Conductor Protection		Self-Protected Type E Manual Combination Controller ❹❺❻		
	Max. Short Circuit Current [kA]		Max. Fuse or Circuit Breaker	Max. Short Circuit Current [kA]		Max. Short Circuit Current [kA]		Max. Short Circuit Current [kA]		Max. Short Circuit Current [kA]	
	480V	600V		480V	600V	480V	600V	480Y/277V	600Y/347V	480Y/277V	600Y/347V
KTA7-25...32S — Standard Interrupting Capacity											
KTA7-25S-0.16A	65	47	450	65	47	65	47	65	47	65	47
KTA7-25S-0.25A	65	47	450	65	47	65	47	65	47	65	47
KTA7-25S-0.4A	65	47	450	65	47	65	47	65	47	65	47
KTA7-25S-0.63A	65	47	450	65	47	65	47	65	47	65	47
KTA7-25S-1A	65	47	450	65	47	65	47	65	47	65	47
KTA7-25S-1.6A	65	47	450	65	47	65	47	65	47	65	47
KTA7-25S-2.5A	65	30	450	65	30	65	30	65	30	65	30
KTA7-25S-4A	65	25	450	65	25	65	25	65	25	65	25
KTA7-25S-6.3A	65	30	450	65	30	65	30	65	~	65	~
KTA7-25S-10A	65	30	450	65	30	65	30	65	~	65	~
KTA7-25S-16A	30	30	450	30	30	30	30	30	~	30	~
KTA7-25S-20A	30	30	450	30	30	10	10	10	~	10	~
KTA7-25S-25A	25	10	450	25	10	10	5	~	~	~	~
KTA7-32S-29A	25	30	450	25	30	10	~	~	~	~	~
KTA7-32S-32A	25	30	450	25	30	10	~	~	~	~	~
KTA7-25...32H — High Interrupting Capacity											
KTA7-25H-2.5A	65	30	450	65	30	65	30	65	30	65	30
KTA7-25H-4A	65	30	450	65	30	65	30	65	30	65	30
KTA7-25H-6.3A	65	30	450	65	30	65	30	65	30	65	30
KTA7-25H-10A	65	30	450	65	30	65	30	65	30	65	30
KTA7-25H-16A	65	30	450	65	30	65	30	65	30	65	30
KTA7-25H-20A	65	30	450	65	30	65	30	65	~	65	~
KTA7-25H-25A	30	30	450	30	30	30	30	30	~	30	~
KTA7-32H-29A	30	30	450	30	30	30	18	~	~	~	~
KTA7-32H-32A	30	30	450	30	30	30	18	~	~	~	~
KTA7-45H — High Interrupting Capacity											
KTA7-45H-10A	65	30	600	65	30	65	30	65	30	65	30
KTA7-45H-16A	65	30	600	65	30	65	30	65	30	65	30
KTA7-45H-20A	65	30	600	65	30	65	30	65	30	65	30
KTA7-45H-25A	65	30	600	65	30	65	30	65	30	65	30
KTA7-45H-32A	65	30	600	65	30	65	30	65	30	65	30
KTA7-45H-45A	65	18	600	65	18	65	18	65	~	65	~

F KT7 Motor Circuit Controllers

- ❶ UL 508, CSA 22.2 No. 14 for group installation, in connection with short-circuit protection device.
- ❷ UL 508 Part III.
- ❸ UL 508 Part IV.
- ❹ Type E applications require use of the KT7-xx-TE terminal adaptor on KT7s. Alternatively, compact busbar supply block KT7-_-A2E or -A3E meet Type E requirements for terminal spacing.
- ❺ Requires lockable twist knob (KT7-KN1 or KT7-KRY1 page F16) or lockable door coupling handle (KT7-HTN or KT7-HTRY page F15).

It should be noted that the KT7 Manual Motor Circuit Controller, when listed as a self-protected (Type E) device, is rated for Wye-connected power systems for voltages above 240 volts (i.e. 480Y/277 volts common in the United States or 600Y/347 volts common in Canada).

KTC7 Base Unit ①

Maximum Horsepower						Current Adjustment Range [A]	Magnetic Release Response Current [A]	Catalog Number
Typical Single Phase		Typical Three Phase [HP]						
115V	230V	200V	230V	460V	575V			
KTC7-25S — Standard Interrupting Capacity								
~	~	~	~	~	~	0.10...0.16	3.2	KTC7-25S-0.16A
~	~	~	~	~	~	0.16...0.25	5.2	KTC7-25S-0.25A
~	~	~	~	~	1/4	0.25...0.40	8.2	KTC7-25S-0.4A
~	~	~	~	1/4	1/3	0.40...0.63	13	KTC7-25S-0.63A
~	~	~	~	1/2	3/4	0.63...1.0	21	KTC7-25S-1A
~	1/10	1/4	1/3	1	1	1.0...1.6	33	KTC7-25S-1.6A
1/10	1/6	1/2	3/4	1-1/2	2	1.6...2.5	52	KTC7-25S-2.5
1/8	1/3	1	1	3	3	2.5...4	82	KTC7-25S-4A
1/4	3/4	1-1/2	2	5	5	4...6.3	130	KTC7-25S-6.3A
1/2	1-1/2	3	3	7-1/2	10	6.3...10	208	KTC7-25S-10A
1	3	5	5	10	15	10...16	260	KTC7-25S-16A
KTC7-25H — High Interrupting Capacity								
1	3	5	5	10	10	10...16	260	KTC7-25H-16A
1-1/2	3	5	7-1/2	15	20	14.5...20	325	KTC7-25H-20A
KTC7-45H — High Interrupting Capacity								
2	3	7-1/2	10	20	25	18...25	416	KTC7-45H-25A
3	5	7-1/2	10	25	30	23...32	585	KTC7-45H-32A

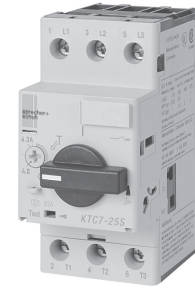

KTC7-25S

Description

The KTC7 has a fixed magnetic trip set at 16...21x the maximum value of the current adjustment range (as opposed to the KTA7s magnetic trip of approximately 13x current adjustment range). KTC7 are typically used in applications where nuisance tripping might occur, as with some high efficiency motors.

F

KTC7 Motor Circuit Controllers

Horsepower ratings shown in the table are for reference only. The final selection of the controller depends on the actual motor full load current and service factor.

- For motor with service factor less than 1.15. Use motor nameplate full load current times 0.9 and choose the motor starter with the appropriate current range. Example: Motor F.L.C. = 4.2A; S.F. = 1.0. - 4.2A x 0.9 = 3.78A. Select Catalog Number KTC7-25S-4A.

① Magnetic trip is fixed at 16...21x the maximum value of the current adjustment range.

KTC7 UL Ratings Application Chart

Device	Manual Motor Starter		Manual Controller for Group Installation ❶			Manual Controller as Motor Disconnect ❷❸		Suitable for Tap Conductor Protection		Self-Protected Type E Manual Combination Controller ❹❺	
	Max. Short Circuit Current [kA]		Max. Fuse or Circuit Breaker	Max. Short Circuit Current [kA]		Max. Short Circuit Current [kA]		Max. Short Circuit Current [kA]		Max. Short Circuit Current [kA]	
	480V	600V		480V	600V	480V	600V	480Y/277V	600Y/347V	480Y/277V	600Y/347V
KTC7-25S — Standard Interrupting Capacity											
KTC7-25S-0.16A	65	47	450	65	47	65	47	65	47	65	47
KTC7-25S-0.25A	65	47	450	65	47	65	47	65	47	65	47
KTC7-25S-0.4A	65	47	450	65	47	65	47	65	47	65	47
KTC7-25S-0.63A	65	47	450	65	47	65	47	65	47	65	47
KTC7-25S-1A	65	47	450	65	47	65	47	65	47	65	47
KTC7-25S-1.6A	65	47	450	65	47	65	47	65	30	65	30
KTC7-25S-2.5A	65	25	450	65	25	65	25	65	25	65	25
KTC7-25S-4A	65	30	450	65	30	65	30	65	~	65	~
KTC7-25S-6.3A	65	30	450	65	30	65	30	65	~	65	~
KTC7-25S-10A	30	30	450	30	30	30	30	30	~	30	~
KTC7-25S-16A	30	30	450	30	30	10	10	10	~	10	~
KTC7-25H — High Interrupting Capacity											
KTC7-25H-16A	65	30	450	65	30	65	30	65	30	65	30
KTC7-25H-20A	30	30	450	30	30	30	30	30	~	30	~
KTC7-45H — High Interrupting Capacity											
KTC7-45H-25A	65	30	600	65	30	65	30	65	30	65	30
KTC7-45H-32A	65	30	600	65	18	65	18	65	18	65	18

F

KT7 Motor Circuit Controllers

- ❶ UL 508, CSA 22.2 No. 14 for group installation, in connection with short-circuit protection device.
- ❷ UL 508 Part III.
- ❸ UL 508 Part IV.
- ❹ Type E applications require use of the KT7-xx-TE terminal adaptor on KT7s. Alternatively, compact busbar supply block KT7-_-A2E or -A3E meet Type E requirements for terminal spacing.
- ❺ Requires lockable twist knob (KT7-KN1 or KT7-KRY1 page F16) or lockable door coupling handle (KT7-HTN or KT7-HTRY page F15).

It should be noted that the KT7 Manual Motor Circuit Controller, when listed as a self-protected (Type E) device, is rated for Wye-connected power systems for voltages above 240 volts (i.e. 480Y/277 volts common in the United States or 600Y/347 volts common in Canada).

KTB7 Base Unit

Maximum Horsepower						Rated Operational Current [A]	Magnetic Release Response Current [A]	Catalog Number
Typical Single Phase		Typical Three Phase [HP]						
115V	230V	200V	230V	460V	575V			
KTB7-25S — Standard Interrupting Capacity								
~	~	~	~	~	1/4	0.40	5.2	KTB7-25S-0.4A
~	~	~	~	1/2	3/4	1.0	13	KTB7-25S-1A
1/10	1/6	1/2	3/4	1-1/2	2	2.5	33	KTB7-25S-2.5A
KTB7-25...32H — High Interrupting Capacity								
1/10	1/6	1/2	3/4	1-1/2	2	2.5	33	KTB7-25H-2.5A
1/8	1/3	1	1	3	3	4	52	KTB7-25H-4A
1/2	1-1/2	3	3	7-1/2	10	10	130	KTB7-25H-10A
1	3	5	5	10	15	16	208	KTB7-25H-16A
2	3	7-1/2	7-1/2	20	20	25	325	KTB7-25H-25A
3	5	7-1/2	10	25	30	32	448	KTB7-32H-32A
KTB7-45H — High Interrupting Capacity								
2	3	7-1/2	10	20	25	25	325	KTB7-45H-25A
3	5	7-1/2	10	25	30	32	416	KTB7-45H-32A
3	7-1/2	10	15	30	40	45	585	KTB7-45H-45A



KTB7-25S

Description

The KTB7 is designed without a thermal trip element (i.e., current adjustment range). It should be selected for applications where a separate motor overload protection device is used, such as on CLT7 Three Component Starters on page F76. Magnetic trip is the same as the KTA7 (approximately 13x operational current).

F KTB7 Motor Circuit Controllers

APPLICATION NOTE: Product Selection for Heavy Duty Starting Applications using KTB7-25S, KTB7-25H/32H and KTB7-45H Motor Circuit Controllers

The KTB7 Motor Circuit Controller is designed and tested to protect a motor circuit in case of a short circuit. A separate Sprecher + Schuh CEP7-EE_ overload relay with selectable trip class should be used to protect the motor against overload.

In Applications with motor starting times exceeding 10 seconds (heavy duty starting) the rated operational current (I_e) of the motor FLA must be multiplied by the following factors for selection of the KTB7 Motor Circuit Controller KTB7-25S, KTB7-25H/32H and KTB7-45H.

Trip classes according to UL 508 Section 52 and IEC 60947-4-1
 CLASS 10 = 1.00 CLASS 15 = 1.22 CLASS 20 = 1.42
 CLASS 25 = 1.58 CLASS 30 = 1.73

The maximum number of motor starts in 25 cycles/hour with a minimum OFF-time of 120 seconds between cycles. This additional calculation and selecting a larger frame size is necessary to compensate (dissipate) the

increased heat resulting from long acceleration applications effecting the rated operational current of the KTB7.

Application Example:

Motor 480 VAC, 10 HP, Ie 14 FLA
 Heavy duty starting application with start time of up to 18 seconds

Solution:

Starting time up to 18 seconds requires dimensioning for CLASS 20.

- Selection of the Motor Circuit Controller for Short Circuit Protection: Multiply the rated operational current I_e with factor for CLASS 20:
 $I_e(20) = 14 \text{ A} \times 1.42 = 19.9 \text{ A}$
- Select corresponding Sprecher + Schuh KTB7-25S, KTB7-25H/32H or KTB7-45H from catalog using next higher current rating:
KTB7-25H-25A

⊕ Horsepower ratings shown in the table are for reference only. The final selection of the controller depends on the actual motor full load current and service factor.

- For motor with service factor less than 1.15. Use motor nameplate full load current times 0.9 and choose the motor starter with the appropriate current range. Example: Motor F.L.C. = 4.2A; S.F. = 1.0. - (4.2A x 0.9 = 3.78A). Select Catalog Number KTB7-25S-4A.

KTB7 UL Ratings Application Chart

Device	Manual Motor Starter		Manual Controller for Group Installation ❶			Manual Controller as Motor Disconnect ❷	
	Max. Short Circuit Current [kA]		Max. Fuse or Circuit Breaker	Max. Short Circuit Current [kA]		Max. Short Circuit Current [kA]	
	480V	600V		480V	600V	480V	600V
KTA7-25S — Standard Interrupting Capacity							
KTB7-25S-0.4A	65	47	450	65	47	65	47
KTB7-25S-1A	65	47	450	65	47	65	47
KTB7-25S-2.5A	65	30	450	65	30	65	30
KTA7-25...32H — High Interrupting Capacity							
KTB7-25H-2.5A	65	30	450	65	30	65	30
KTB7-25H-4A	65	30	450	65	30	65	30
KTB7-25H-10A	65	30	450	65	30	65	30
KTB7-25H-16A	65	30	450	65	30	65	30
KTB7-25H-25A	30	30	450	30	30	30	30
KTB7-32H-32A	30	30	450	30	30	30	18
KTA7-45H — High Interrupting Capacity							
KTB7-45H-25A	65	30	600	65	30	65	30
KTB7-45H-32A	65	30	600	65	30	65	30
KTB7-45H-45A	65	18	600	65	18	65	18

F

KT7 Motor Circuit Controllers

❶ UL 508, CSA 22.2 No. 14 for group installation, in connection with short-circuit protection device.
 ❷ UL 508 Part III.

KTV7 Base Unit

Rated Operational Current (I _e) [A]	Current Adjustment Range [A]	Nominal Magnetic Trip Current [A]	Maximum Short Circuit Current [kA]		Maximum Horsepower Typical ①② Three Phase [HP]				Catalog Number
			480Y/277V Type E	480V (group motor)	200V	230V	460V	575V	
KTV7-25H...32H — High Interrupting Capacity									
1.6	1.0...1.6	82	65	65	1/4	1/3	1	~	KTV7-25H-1.6A
2.5	1.6...2.5	82	65	65	1/2	3/4	1-1/2	~	KTV7-25H-2.5A
4.0	2.5...4.0	82	65	65	1	1	3	~	KTV7-25H-4A
6.3	4.0...6.3	82	65	65	1-1/2	2	5	~	KTV7-25H-6.3A
10	6.3...10	130	65	65	3	3	7-1/2	~	KTV7-25H-10A
16	10...16	208	65	65	5	5	10	~	KTV7-25H-16A
20	14.5...20	260	65	65	5	7-1/2	15	~	KTV7-25H-20A
25	18...25	325	30	30	7-1/2	7-1/2	20	~	KTV7-25H-25A
29	24...29	406	~	30	7-1/2	10	20	~	KTV7-32H-29A
32	27...32	448	~	30	7-1/2	10	25	~	KTV7-32H-32A



KTV7-25H

F KTV7 Motor Circuit Controllers

Description

The Sprecher+Schuh KTV7 series motor controllers are suitable for two types of applications under cULus listings:

- (1) as a Manual, Self-protected Motor Controller or
- (2) as a Manual Motor Controller with approval for group installation (and as a motor disconnect)

When UL/CSA listed as a manual, self-protected combination motor controller, the KTV7 provides all of the necessary NEC requirements for protection and control of individual motor branch circuits without additional protective devices (per NEC 430-52C option 6).

When KTV7 devices are applied as manual motor controllers in group installations, then NEC group installation rules state these devices must be applied per the appropriate rules, which require the use of an upstream BCPD-branch circuit protection device (per NEC 430-53C option 2).

The output frequency of the VFD must be limited to 400Hz or less to prevent thermal degradation. Various models of the KTV7 series self-protected combination motor controllers provide disconnection for motor branch circuits, branch-circuit and short-circuit protection (including magnetic protection), overload/thermal protection and manual switching.

The KTV7 self-protected combination motor controllers are current limiting and have a fixed magnetic trip. Interrupt ratings at 400V and 480V are available up to 65kAIC. The VFD output pulse-width modulation frequency must be limited to 4 kilohertz or less. The circuit breakers provide motor overload protection with a trip class 10 characteristic.

Horsepower ratings shown in the table are for reference only. The final selection of the controller depends on the actual motor full load current and service factor.

- For motor with service factor less than 1.15. Use motor nameplate full load current times 0.9 and choose the motor starter with the appropriate current range. Example: Motor F.L.C. = 4.2A; S.F. = 1.0. – 4.2A x 0.9 = 3.78A. Select Catalog Number KTV7-25H-4A.

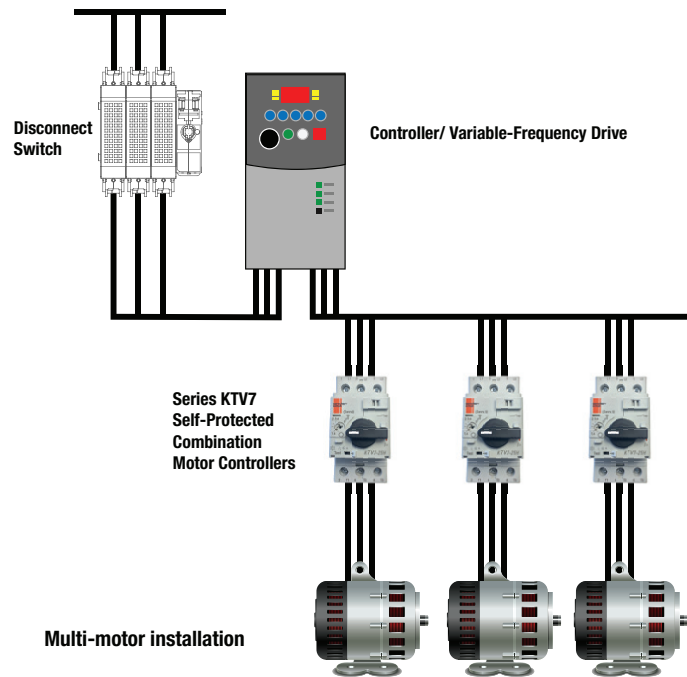















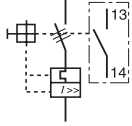
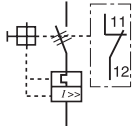



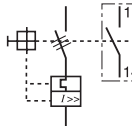

① HP ratings shown are for reference. Final selection of MPCB is determined by actual motor full load current.
 ② Not applicable at 575V.

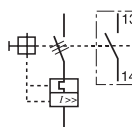
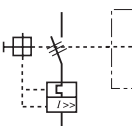
KTV7 UL Ratings Application Chart

Device	Manual Controller for Group Installation ❶		Manual Controller as Motor Disconnect ❷❸		Suitable for Tap Conductor Protection		Self-Protected Type E Manual Combination Controller ❹❺		
	Max. Fuse or Circuit Breaker	Max. Short Circuit Current [kA]		Max. Short Circuit Current [kA]		Max. Short Circuit Current [kA]		Max. Short Circuit Current [kA]	
		480V	600V	480V	600V	480Y/277V	600Y/347V	480Y/277V	600Y/347V
KTV7-25H...32H — High Interrupting Capacity									
KTV7-25H-1.6A	450	65	~	65	~	65	~	65	~
KTV7-25H-2.5A	450	65	~	65	~	65	~	65	~
KTV7-25H-4A	450	65	~	65	~	65	~	65	~
KTV7-25H-6.3A	450	65	~	65	~	65	~	65	~
KTV7-25H-10A	450	65	~	65	~	65	~	65	~
KTV7-25H-16A	450	65	~	65	~	65	~	65	~
KTV7-25H-20A	450	65	~	65	~	65	~	65	~
KTV7-25H-25A	450	30	~	30	~	30	~	30	~
KTV7-32H-29A	450	30	~	30	~	~	~	~	~
KTV7-32H-32A	450	30	~	30	~	~	~	~	~

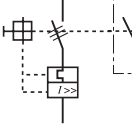
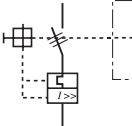
- ❶ UL 508, CSA 22.2 No. 14 for group installation, in connection with short-circuit protection device.
- ❷ UL 508 Part III.
- ❸ UL 508 Part IV.
- ❹ Type E applications require use of the KT7-xx-TE terminal adaptor on KT7s.
Alternatively, compact busbar supply block KT7-_-A2E or -A3E meet Type E requirements for terminal spacing.
- ❺ Requires lockable twist knob (KT7-KN1 or KT7-KRY1 page F16) or lockable door coupling handle (KT7-HTN or KT7-HTRY page F15).

Accessories for KT7

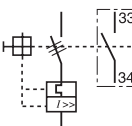

Accessory	Description	Operator Position ❶			Type	Connection Diagram and Terminal Markings ❷	For Use With	Catalog Number
		OFF	ON	Tripped				
					1 NO		KTA7/KB7/ KTC7/KTV7 KTU7 ❸	KT7-PE1-10
		X	0	X	1 NC		KTA7/KB7/ KTC7/KTV7 KTU7 ❸	KT7-PE1-01
	Front-Mounted Auxiliary Contact <ul style="list-style-type: none"> • 1-pole or 2-pole • No additional space required • 300V max. 				1 NO		KTA7/KB7/ KTC7/KTV7 KTU7 ❸	KT7-PE1-11
		X	0	X	1 NC			
					1 NO		KTA7/KB7/ KTC7/KTV7 KTU7 ❸	KT7-PE1-20
		0	X	0	1 NO			
		X	0	X	1 NC		KTA7/KB7/ KTC7/KTV7 KTU7 ❸	KT7-PE1-02
		X	0	X	1 NC			
	Right Side-Mounted Auxiliary Contact <ul style="list-style-type: none"> • 2-pole • Adds 9 mm to the width of the device • 600V max. 				1 NO		KTA7 KTB7 KTC7 KTV7	KT7-PA1-20
		0	X	0	1 NO			
		X	0	X	1 NC		KTA7 KTB7 KTC7 KTV7	KT7-PA1-02
		X	0	X	1 NC			
					1 NO		KTA7 KTB7 KTC7 KTV7	KT7-PA1-11
		X	0	X	1 NC			

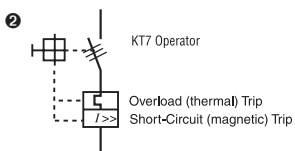
❶ X=Contact Closed
0=Contact Open

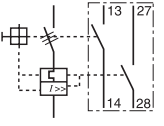
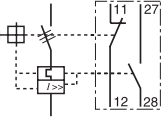

❸ When KT7-PE_ is used with KTU7 Circuit Breakers, KT7-PEFC Load Terminal Cover is required to comply with UL489 terminal clearance standards.

Accessories for KT7

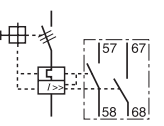
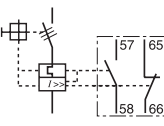
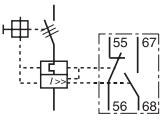
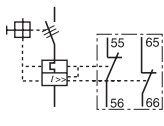
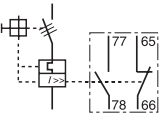

Accessory	Description	Operator Position ❶			Type	Connection Diagram and Terminal Markings ❷	For Use With	Catalog Number
		OFF	ON	Tripped				
	Front-Mounted Trip Contact <ul style="list-style-type: none"> • 2-pole • Indicates tripping of device • No additional space required • 300V max. 	0	X	0	1 NO		KTA7/ KTB7/ KTC7/ KTV7 KTU7 ❸	KT7-PEF1-S10-N10
		0	0	X	NO Trip (Short-Circuit & Overload)			
		X	0	X	1 NC		KTA7/ KTB7/ KTC7/ KTV7 KTU7 ❸	KT7-PEF1-S10-N01
		0	0	X	NO Trip (Short-Circuit & Overload)			
	Right Side-Mounted Trip Contact <ul style="list-style-type: none"> • 2-pole • Indicates tripping of motor protector • Adds 9 mm to the width of the device • 600V max. 	0	0	X	NO Trip (Short-Circuit & Overload)		KTA7 KTB7 KTC7 KTV7	KT7-PAF1-S10-M10
		0	0	X	NO Trip (Short-Circuit)			
		0	0	X	NO Trip (Short-Circuit & Overload)		KTA7 KTB7 KTC7 KTV7	KT7-PAF1-S10-M01
		X	X	0	NC Trip (Short-Circuit)			
		X	X	0	NC Trip (Short-Circuit & Overload)		KTA7 KTB7 KTC7 KTV7	KT7-PAF1-S01/M10
		0	0	X	NO Trip (Short-Circuit)			
		X	X	0	NC Trip (Short-Circuit & Overload)		KTA7 KTB7 KTC7 KTV7	KT7-PAF1-S01-M01
		X	X	0	NC Trip (Short-Circuit)			
		0	0	X	NO Trip (Short-Circuit)		KTA7 KTB7 KTC7 KTV7	KT7-PAF1-M11
		X	X	0	NC Trip (Short-Circuit)			

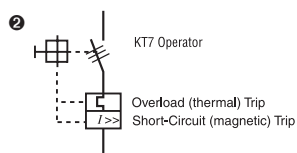
❶ X=Contact Closed
O=Contact Open





❸ When KT7-PE_ is used with KTU7 Circuit Breakers, KT7-PEFC Load Terminal Cover is required to comply with UL489 terminal clearance standards.

Classic Handle Assembly, Type 1/4/4X/12

Accessory	Description	Color	Legend ②	For use with...	Frame Size (Length)	Catalog Number
	Classic Door Coupling Handle ①②③ <ul style="list-style-type: none"> For 3 padlocks 4...8 mm (5/16") diameter Type 1/3/3R/4/4X/12 and IP66 Interlock override capability Can be modified for locking in ON position Ships with coupling — order extension shaft and legend plate separately See Technical Section for mounting depth information 	Gray/Black	0 - I OFF - ON Trip	KTA7, KTB7, KTC7, KTV7 ①② KTU7 ③	65 x 65mm	KT7-HTN
		Red/Yellow	0 - I OFF - ON Trip		65 x 65mm	KT7-HTRY
	Extension Shaft ① <ul style="list-style-type: none"> Cut to required length for mounting depth (adapter-door) See Technical Section for mounting depth information 			KT7-HTN KT7-HTRY	250 mm	KT7-HT
		400 mm	KT7-HTL			

Contemporary Handle Assembly, Type 3R/3/4/4X

Accessory	Description	Color	Legend ②	For use with...	Frame Size (Length)	Catalog Number
	Contemporary Door Coupling Handle ④ <ul style="list-style-type: none"> Screw Fixing Type 3R, 3, 12, 4, 4X, IP66 Field configurable for defeatable or non-defeatable Ships with coupling — order extension shaft and legend plate separately Requires 30mm hole for mounting For up to 2 padlocks 	Black/Black	0 - I OFF - ON Trip	KTA7 KTB7 KTC7 KTV7 KTU7	48.7 x 47mm	KT7-SB
		Red/Yellow	0 - I OFF - ON Trip		48.7 x 47mm	KT7-SY
	Extension Shaft <ul style="list-style-type: none"> Cut to required length for mounting depth (adapter-door) See Technical Section for mounting depth information 			KT7-SB KT7-SY	305mm (12")	KT7-S1
		533mm (21")	KT7-S2			

Handle Accessories

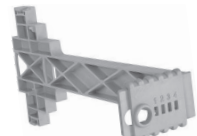
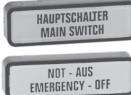
Accessory	Description	For use with...	Catalog Number
	Extension Shaft Support ⑤ <ul style="list-style-type: none"> Provides consistent alignment of the KT7 shafts with handle or door coupling Recommended for shaft lengths >200mm (7.8 in) 9mm in width and snaps on right side of KT_7 devices Allows for one side-mount auxiliary 	KT7-HT_ KT7-S_ KT7-N_ KT7-S_	KT7-SHS
	Legend Plate <ul style="list-style-type: none"> Marking: "Hauptschalter" and "Main Switch" (Black/Gray) Marking: "Not-Aus" and "Emergency Off" (Black/Yellow) 	KT7-HT_ KT7-S_ KT7-S_	KT7-HTFCN KT7-HTFCRY

① See Dimensions and Technical data in this section for design compatibility.

② KTA7, KTB7 and KTC7 can be used with Series D or later KT7-H_ Handle mechanism with "I-O" markings or Series E with "ON-OFF" markings.

③ KTU7 requires Series E or later to comply with UL489 "ON-OFF" Trip





markings.

④ See page F41 for assembly example and dimensions.

⑤ See page F42 for KT7-S_ handle dimensions.

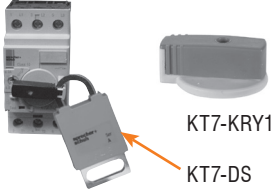

DISCONTINUED

Accessories for KT_7

Accessory	Description	Color	For Use With	Catalog Number
 <p>KT7-KRY1 KT7-DS</p>	Lockable Twist Knob <ul style="list-style-type: none"> For 1 padlock 4...5 mm (1/4") dia. shackle Can be locked in OFF position 	Black	KTA7, KTB7, KTC7, KTV7, KTU7	KT7-KN1
		Red/Yellow		KT7-KRY1
	Locking Tag <ul style="list-style-type: none"> Padlock attachment to the lockable handles Up to three padlocks 4...8 mm (5/16") shackle 	Red	KT7-KN1, KT7-KRY1, KT7-45-KRY	KT7-DS
	Terminal Adapter for Type E Applications ❶ <ul style="list-style-type: none"> Required on all KT7s used in UL Type E applications May not be used with Bus Bars 		KTA/B/C7/V7-25/32	KT7-25-TE1
			KTA/B/C7-45	KT7-45-TE
	Anti-Tamper Shield <ul style="list-style-type: none"> Provides protection against inadvertent adjustment of the current setting 10 pieces per package 		KTA7, KTB7, KTC7, KTV7	KT7-25-CA
	Screw Adaptor <ul style="list-style-type: none"> For screw fixing of KT7 Motor Circuit Controller 10 pieces per package 		KTA7, KTB7, KTC7, KTV7, KTU7	KT7-45-AS

F KT7 Motor Circuit Controllers

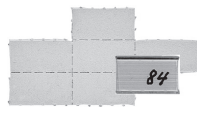
Marking Systems

Component	Description	Pkg. Qty.	Catalog Number
	Label Sheet - 1 sheet with 105 self-adhesive paper labels each, 6 x 17mm	1	CA7-FMS
	Marking Tag Sheet - 1 sheet with 160 perforated paper labels each, 6 x 17mm. To be used with transparent cover	1	CA7-FMP
	Transparent Cover - To be used with Marking Tag Sheets	100 ❷	CA7-FMC
	Tag Carrier - For marking with marker cards and tags. See page N6 for complete listing of available cards and tabs.	100 ❷	CA7-FMA2

❶ Terminal Adaptors are supplied as standard on enclosed KT7 and CX7 starters, as well as, CL8, CL7 and CK7 assembled products, assuring they can be used in Type E applications. Alternatively, compact busbar supply block KT7-_-A2E or -A3E meet Type E requirements for terminal spacing.

❷ Minimum quantity is one package of 100.

Connecting Modules (for connecting KTA7, KTB7 or KTC7 to CA8, CA7 AC coil, or CA7 Electronic DC coil contactors) ②

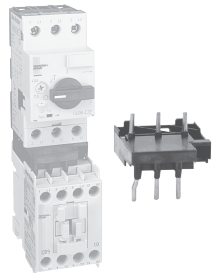

Module	Description	For Connecting. . .	To Contactor. . .	Catalog Number ①
	Connecting Modules (forms Ecombo Starter) - ① <ul style="list-style-type: none"> Provides electrical and mechanical interconnection of KT7 and CA8 (with AC or DC coils), CA7 (with AC coils) or CA7-_E (with Electronic DC coils). Suitable for reversing and wye-delta kits Ecombo starter (with KT7-25/32) mounts on a single DIN-rail (KT7 mounts on DIN-rail) Ecombo starter (with KT7-45) can be mounted on two DIN-rails or on Mounting Modules (see selection table below) Contactor coil mounted on load side 	KT_7-25S..32S or KF7	CA8-9...12 12A max.	KT7-25S-PEK12
		KT_7-25S..32S or KF7	CA7-9...23 CA7-9E...23E	KT7-25S-PEC23
		KT_7-25H..32H	CA7-9...23 CA7-9E...23E	KT7-25H-PEC23
		KT_7-25H..32H	CA7-30...37 CA7-30E...37E	KT7-25H-PNC37
		KT_7-45H	CA7-30...37 CA7-30E...37E	KT7-45H-PNC37
		KT_7-45H	CA7-43 CA7-43E	KT7-45H-PNC43

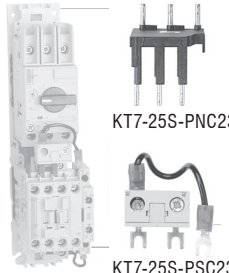
Connecting Modules (for connecting KTA7, KTB7 or KTC7 to CA7 to make CLT7 type assemblies) ②

Module	Description	For Connecting...	To Contactor. . .	Use Contactor. . . ①	With Coil Module. . .
	Connecting Modules <ul style="list-style-type: none"> Provides electrical interconnection of KT7 and CA7 contactors Contactor Coil Module extends A1/A2 Line Side terminals forward to facilitate wiring Contactor and motor protector must be mounted on two DIN-rails or on Mounting Module (see selection table below) 	KT_7-25S..32S or KF7	CA7-9..23	KT7-25S-PNC23	KT7-25S-PSC23
		KT_7-25H..32H		KT7-25H-PNC23	
		KT_7-25H..32H	CA7-30..37	KT7-25H-PNC37	KT7-45H-PSC43
		KT_7-45H		KT7-45H-PNC37	
		KT_7-45H		KT7-45H-PNC43	

F
KT7 Motor Circuit Controllers

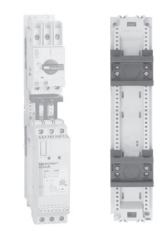
Type W Mounting Modules

Module	Description	Width (mm)	Catalog Number
	Short Mounting Module - Requires Connecting Module from tables above <ul style="list-style-type: none"> Provides support for KT7 + CA7 or CA8 Top rail is specifically designed for KT7 Bottom rail is movable for easy assembly and disassembly Complete unit mounts to two 35mm DIN-rails or one 70mm DIN-rail or screw mounts 228 mm long 	45	W-32489
		54	W-32490
	Long Mounting Module - See Section D for Connecting Modules <ul style="list-style-type: none"> Provides support for KT7 + PCS Softstarter, CA7 + PCS Softstarter or KTB7 + CA7+CEP7 Top rail is specifically designed for KT7 Bottom rail is movable for easy assembly and disassembly Complete unit mounts to two 35mm DIN-rails or one 70mm DIN-rail or screw mounts 283 mm long 	45	W-32496
		54	W-32497
	Spacer for Mounting Module - Fits between 45mm and 54mm for Reversing applications (228 mm long)	9	W-32955
	Dovetail Joints - Used to connect two mounting modules together. (Sold in packages of 50)		W-32954

① cURus Approved (File # E33916).
 ② Not for use with KTU7 Circuit Breakers



DISCONTINUED

Compact Busbar System for KTA7, KTB7 and KTC7 Motor Controllers ①②④

Accessory	Description	For Use With	Catalog Number
	Compact Busbar — 45 mm Spacing (Rated 64 A) <ul style="list-style-type: none"> For use with front-mounted auxiliary contact on KT_7 Motor Controllers Connects 2 Motor Controllers Connects 3 Motor Controllers Connects 4 Motor Controllers Connects 5 Motor Controllers 	KT_7-25...32S KT_7-25...32H ③	KT7-32-DB-45-2 KT7-32-DB-45-3 KT7-32-DB-45-4 KT7-32-DB-45-5
	Compact Busbar — 54 mm Spacing (Rated 64 A) <ul style="list-style-type: none"> For use with side-mounted auxiliary contact on KT_7 Motor Controllers Connects 2 Motor Controllers Connects 3 Motor Controllers Connects 4 Motor Controllers Connects 5 Motor Controllers 	KT_7-25...32S KT_7-25...32H ③	KT7-32-DB-54-2 KT7-32-DB-54-3 KT7-32-DB-54-4 KT7-32-DB-54-5
	Compact Busbar — 54mm Spacing (Rated 120 A) <ul style="list-style-type: none"> For use with front-mounted auxiliary contact on KT_7 Motor Controllers Connects 2 Motor Controllers Connects 3 Motor Controllers Connects 4 Motor Controllers 	KT_7-45H	KT7-45-DB-54-2 KT7-45-DB-54-3 KT7-45-DB-54-4
	Compact Busbar — 63 mm Spacing (Rated 120 A) <ul style="list-style-type: none"> For use with side-mounted auxiliary contact on KT_7 Motor Controllers Connects 2 Motor Controllers Connects 3 Motor Controllers Connects 4 Motor Controllers 	KT_7-45H	KT7-45-DB-63-2 KT7-45-DB-63-3 KT7-45-DB-63-4
 KTA7-25S to 25H KBH2	Spacer for KT_7-25...32H to KT_7-25...32S <ul style="list-style-type: none"> Accommodates difference in depth from KT_7-25H...32H to KT_7-25S...32S Aligns terminals for compact bus bar connection 	KT_7-25...32S to KT_7-25...32H ③	KBH2
 A2E A3E	Supply Block and Terminal <ul style="list-style-type: none"> For power connection to Compact Busbar — 600V, KT_7-25/32...63A max. / KT_7-45...120A maximum Top feed — overlaps commoning link Meets requirements for terminal spacing from source in Type E applications KT7-25-A2E and KT7-45-A2E are primarily used for bottom cable feed 	KT_7-25...32S or KT_7-25...32H ③	KT7-25-A2E KT7-32-A3E
		KT_7-45H	KT7-45-A2E KT7-45-A3E
	Terminal Cover <ul style="list-style-type: none"> For covering of unused connection terminals IP2X finger protection 	KT_7-25...32 KT_7-45H	KT7-32-DBA KT7-45-DBA

- ① UL Approved (File #E33916); CSA Approved (File #13908).
- ② Compact busbar may not be applied with KT7-25-TE1 or KT7-45-TE Terminal Adaptors. Either Terminal Adaptors or Bus Bar may be used, not both.
- ③ KT7-25...32S and KT7-25...32H may not be combined without KBH2.
- ④ Not for use with KTU7 Circuit Breakers

KF7 Fuse Holder to be used with KT7 or CA8/CA7 ⑤

Accessory	Description	Approvals		Catalog Number
		IEC/CE	UL/CSA	
	KF7 Fuse Holder, CC - 30A	Yes	Yes	KF7-D3C-C30
 Blown Fuse Indicator	KF7 Fuse Holder with Blown Fuse Indication, CC - 30A	Yes	Yes	KF7-D3C-C30L

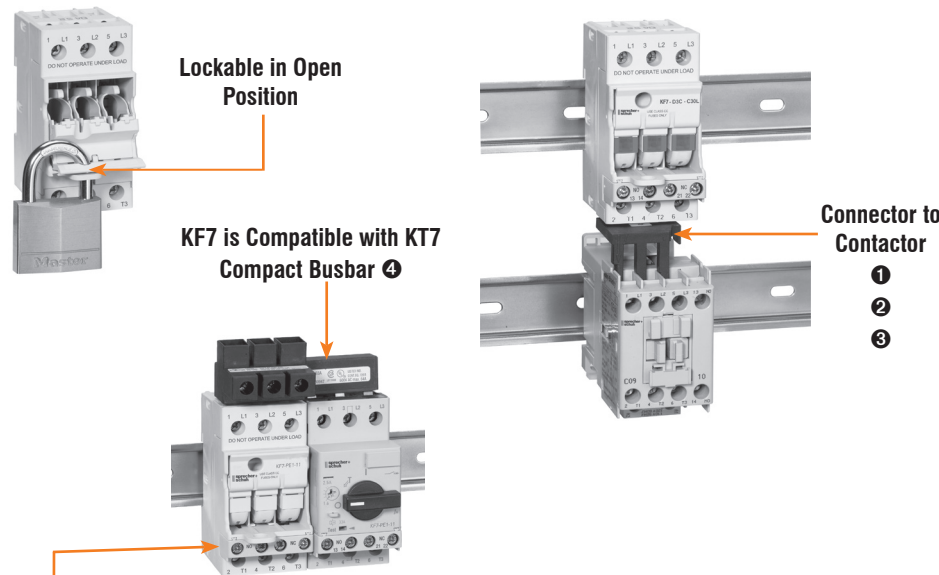

Applying KF7 with KTA7 Motor Circuit Controllers and CA7 Contactors

KF7 can be applied on the line side of a multiple small KTA7 motor circuit controller or a single KTA7 controller and CA7 contactors to increase the short-circuit protection of the group or a single branch circuit. KF7 is compatible with the KT7 compact bus bars (as shown in Section F), which reduces the space requirement as well as installation time.

Applying KF7 with CA7 Contactors

KF7 can be applied on the line side of CA7 contactors to increase the short-circuit withstand rating. The cUL withstand rating of CA7 when protected by Type "CC" fuses is increased to 100KAIC as shown on page A72.

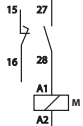
Accessory	Connection Diagram	Description	Catalog Number
		<p>Auxiliary Contact for KF7 Fuse Holder (1 NO Late Make + NC Early Break)</p> <ul style="list-style-type: none"> • NO Late Make, provides positive indication that power circuit is open • NC Early Break, provides capability for dropping out contactor before breaking current on fuse 	KF7-PE1-11

- ① The KF7 terminal spacing and height are the same as KT_7-25S. Reference page F17 tables to select a connector.
- ② If using a KT7-25S-PEK12 (with CA8) or KT7-25S-PEC23 (with CA7), close couple connector, then the pair mounts on a single DIN rail under the KF7.
- ③ Using a KT7-25S-PNC23 to mount a KF7 with a standard CA7 with AC Coil requires two DIN rails.
The A1-A2 terminals of a standard CA7 with AC Coil can be turned to the load side. In this case a KT7-25S-PSC23 would not be required.
- ④ KF7 can not be mounted directly to a KT_7 using a PEK, PEC or PNC Connector. KF7, used in connection with a Compact Bus Bar, can provide Group Fusing protection for multiple bus bar connected KT_7.
- ⑤ For dimensions and wiring diagrams see page F44.

F
KT7 Motor Circuit Controllers

IEC Performance Data

		Catalog Number KTA7-25S...32S														
		0.16A	0.25A	0.4A	0.63A	1A	1.6A	2.5A	4A	6.3A	10A	16A	20A	25A	29A	32A
Rated Operational Current, I_e	[A]	0.16	0.25	0.4	0.63	1	1.6	2.5	4	6.3	10	16	20	25	29	32
Magnetic Release Current	[A]	2.1	3.3	5.2	8.2	13	21	33	52	82	130	208	260	325	406	448
Switching of Standard Three-Phase Motors																
AC-2, AC-3																
230/240V	[kW]	~	~	0.06	0.09	0.18	0.25	0.37	0.75	1.5	2.2	4.0	5.5	5.5	7.5	7.5
400/415V	[kW]	0.02	0.04	0.09	0.18	0.25	0.55	0.75	1.5	2.2	4.0	7.5	10	11	13	15
500V	[kW]	0.06	0.09	0.12	0.18	0.37	0.75	1.1	2.2	3.0	6.3	10	11	15	18.5	20
690V	[kW]	0.06	0.09	0.18	0.25	0.55	1.1	1.8	3.0	4.0	7.5	13	17	22	25	25
Back-up Fuses																
gG, gL, only if $I_{cc} \geq I_{cu}$																
230/240V	[A]	⓪	⓪	⓪	⓪	⓪	⓪	⓪	⓪	⓪	⓪	⓪	100	100	125	125
400/415V	[A]	⓪	⓪	⓪	⓪	⓪	⓪	⓪	⓪	⓪	⓪	80	100	100	125	125
440/460V	[A]	⓪	⓪	⓪	⓪	⓪	⓪	⓪	⓪	⓪	63	63	80	80	100	100
500V	[A]	⓪	⓪	⓪	⓪	⓪	⓪	⓪	⓪	⓪	80	80	80	80	100	100
690V	[A]	⓪	⓪	⓪	⓪	⓪	16	20	35	50	50	63	63	63	80	80
Ultimate Short-Circuit Breaking Capacity																
I_{cu}																
230/240V	[kA]	100	100	100	100	100	100	100	100	100	100	100	65	65	50	50
400/415V	[kA]	100	100	100	100	100	100	100	100	100	100	65	50	15	15	15
440/460V	[kA]	100	100	100	100	100	100	100	100	100	50	10	6	6	6	6
500V	[kA]	100	100	100	100	100	100	100	100	100	50	10	6	6	6	6
690V	[kA]	100	100	100	100	100	8	6	6	4	4	3	3	3	3	3
Rated Service Short-Circuit Breaking Capacity																
I_{cs}																
230/240V	[kA]	100	100	100	100	100	100	100	100	100	100	100	50	50	25	25
400/415V	[kA]	100	100	100	100	100	100	100	100	100	100	50	15	15	15	15
440/460V	[kA]	100	100	100	100	100	100	100	100	100	50	6	6	6	6	6
500V	[kA]	100	100	100	100	100	100	100	100	100	50	6	6	6	6	6
690V	[kA]	100	100	100	100	100	8	6	6	4	4	3	3	3	3	3

⓪ No backup fuse required.

IEC Performance Data

		Catalog Number KTA7-25H...32H								Catalog Number KTA7-45H...						
		2.5A	4A	6.3A	10A	16A	20A	25A	29A	32A	10A	16A	20A	25A	32A	45A
Rated Operational Current, I_e	[A]	2.5	4	6.3	10	16	20	25	29	32	10	16	20	25	32	45
Magnetic Release Current	[A]	33	52	82	130	208	260	325	406	448	130	208	260	325	416	585
Switching of Standard Three-Phase Motors																
AC-2, AC-3																
230/240V	[kW]	0.37	0.75	1.5	2.2	4.0	5.5	5.5	7.5	7.5	2.2	4.0	5.5	6.3	7.5	13
400/415V	[kW]	0.75	1.5	2.2	4.0	7.5	10	11	13	15	4.0	7.5	10	11	15	22
500V	[kW]	1.1	2.2	3.0	6.3	10	11	15	18.5	20	6.3	10	11	15	20	30
690V	[kW]	1.8	3.0	4.0	7.5	13	17	22	25	25	7.5	13	17	22	30	40
Back-up Fuses																
gG, gL, only if $I_{cc} \geq I_{cu}$																
230/240V	[A]	⓪	⓪	⓪	⓪	⓪	⓪	⓪	⓪	⓪	⓪	⓪	⓪	⓪	⓪	⓪
400/415V	[A]	⓪	⓪	⓪	⓪	⓪	100	100	125	125	80	100	100	100	125	125
440/460V	[A]	⓪	⓪	⓪	⓪	80	100	100	125	125	80	100	100	100	125	125
500V	[A]	⓪	⓪	⓪	⓪	80	80	80	100	100	80	100	100	100	125	125
690V	[A]	20	35	50	50	63	63	63	80	80	63	80	80	80	100	100
Ultimate Short-Circuit Breaking Capacity																
I_{cu}																
230/240V	[kA]	100	100	100	100	100	100	100	65	65	100	100	100	100	100	100
400/415V	[kA]	100	100	100	100	100	100	65	50	50	100	100	100	65	65	65
440/460V	[kA]	100	100	100	50	50	50	50	25	25	65	65	65	65	65	50
500V	[kA]	100	100	100	50	50	50	50	25	25	50	50	50	50	50	50
690V	[kA]	10	10	6	6	6	6	6	6	6	10	10	10	10	10	10
Rated Service Short-Circuit Breaking Capacity																
I_{cs}																
230/240V	[kA]	100	100	100	100	100	100	100	50	50	100	100	100	100	100	100
400/415V	[kA]	100	100	100	100	50	25	25	25	25	50	50	50	50	50	50
440/460V	[kA]	100	100	100	50	50	25	25	20	20	50	50	50	50	50	50
500V	[kA]	100	100	100	50	50	25	25	20	20	50	50	50	50	50	50
690V	[kA]	10	10	6	6	4	4	4	4	4	10	10	10	10	6	6

⓪ No backup fuse required.

IEC Performance Data

		Catalog Number KTB7-25S...						
		0.16A	0.25A	0.4A	0.63A	1A	1.6A	2.5A
Rated Operational Current, I_e	[A]	0.16	0.25	0.4	0.63	1	1.6	2.5
Magnetic Release Current	[A]	2.1	3.3	5.2	8.2	13	21	32
Switching of Standard Three-Phase Motors								
AC-2, AC-3								
230/240V	[kW]	~	~	0.06	0.09	0.18	0.25	0.37
400/415V	[kW]	0.02	0.04	0.09	0.18	0.25	0.55	0.75
500V	[kW]	0.06	0.09	0.12	0.18	0.37	0.75	1.1
690V	[kW]	0.06	0.09	0.18	0.25	0.55	1.1	1.8
Back-up Fuses								
gG, gL, only if $I_{cc} \geq I_{cu}$								
230/240V	[A]	①	①	①	①	①	①	①
400/415V	[A]	①	①	①	①	①	①	①
440/460V	[A]	①	①	①	①	①	①	①
500V	[A]	①	①	①	①	①	①	①
690V	[A]	①	①	①	①	①	16	20
Ultimate Short-Circuit Breaking Capacity								
I_{cu}								
230/240V	[kA]	100	100	100	100	100	100	100
400/415V	[kA]	100	100	100	100	100	100	100
440/460V	[kA]	100	100	100	100	100	100	100
500V	[kA]	100	100	100	100	100	100	100
690V	[kA]	100	100	100	100	100	10	6
Rated Service Short-Circuit Breaking Capacity								
I_{cs}								
230/240V	[kA]	100	100	100	100	100	100	100
400/415V	[kA]	100	100	100	100	100	100	100
440/460V	[kA]	100	100	100	100	100	100	100
500V	[kA]	100	100	100	100	100	100	100
690V	[kA]	100	100	100	100	100	8	6

① No backup fuse required.

IEC Performance Data

		Catalog Number KTB7-25H...32H							Catalog No. KTB7-45H...		
		2.5A	4A	6.3A	10A	16A	25A	32A	25A	32A	45A
Rated Operational Current, I_e	[A]	2.5	4	6.3	10	16	25	32	25	32	45
Magnetic Release Current	[A]	32	52	82	130	208	325	448	325	416	585
Switching of Standard Three-Phase Motors											
AC-2, AC-3											
230/240V	[kW]	0.37	0.75	1.5	2.2	4.0	5.5	7.5	6.3	7.5	13
400/415V	[kW]	0.75	1.5	2.2	4.0	7.5	11	15	11	15	22
500V	[kW]	1.1	2.2	3.0	6.3	10	15	20	15	20	30
690V	[kW]	1.8	3.0	4.0	7.5	13	22	25	22	25	40
Back-up Fuses											
gG, gL, only if $I_{cc} \geq I_{cu}$											
230/240V	[A]	①	①	①	①	①	①	①	100	125	125
400/415V	[A]	①	①	①	①	①	100	125	100	125	125
440/460V	[A]	①	①	①	①	80	100	125	100	125	125
500V	[A]	①	①	①	①	80	80	100	100	125	125
690V	[A]	20	35	50	50	63	63	80	80	100	100
Ultimate Short-Circuit Breaking Capacity											
I_{cu}											
230/240V	[kA]	100	100	100	100	100	100	65	100	100	100
400/415V	[kA]	100	100	100	100	100	65	50	100	65	65
440/460V	[kA]	100	100	100	50	50	50	25	65	65	50
500V	[kA]	100	100	100	50	50	25	25	50	50	50
690V	[kA]	10	6	10	6	6	6	6	10	10	10
Rated Service Short-Circuit Breaking Capacity											
I_{cs}											
230/240V	[kA]	100	100	100	100	100	100	50	100	100	100
400/415V	[kA]	100	100	100	100	50	25	25	50	50	50
440/460V	[kA]	100	100	100	50	50	25	20	50	50	50
500V	[kA]	100	100	100	50	50	25	20	50	50	50
690V	[kA]	10	6	10	6	4	4	4	10	6	6

① No backup fuse required.

IEC Performance Data

		Catalog Number KTC7-25S...										
		0.16A	0.25A	0.4A	0.63A	1A	1.6A	2.5A	4A	6.3A	10A	16A
Rated Operational Current, I_e	[A]	0.16	0.25	0.4	0.63	1	1.6	2.5	4	6.3	10	16
Magnetic Release Current	[A]	3.2	5.2	8.2	13	21	32	52	82	130	208	260
Switching of Standard Three-Phase Motors												
AC-2, AC-3												
230/240V	[kW]	~	~	0.06	0.09	0.18	0.25	0.37	0.75	1.5	2.2	4.0
400/415V	[kW]	0.02	0.04	0.09	0.18	0.25	0.55	0.75	1.5	2.2	4.0	7.5
500V	[kW]	0.06	0.09	0.12	0.18	0.37	0.75	1.1	2.2	3.0	6.3	10
690V	[kW]	0.06	0.09	0.18	0.25	0.55	1.1	1.8	3.0	4.0	7.5	13
Back-up Fuses												
gG, gL, only if $I_{cc} \geq I_{cu}$												
230/240V	[A]	⓪	⓪	⓪	⓪	⓪	⓪	⓪	⓪	⓪	⓪	⓪
400/415V	[A]	⓪	⓪	⓪	⓪	⓪	⓪	⓪	⓪	⓪	⓪	80
440/460V	[A]	⓪	⓪	⓪	⓪	⓪	⓪	⓪	⓪	⓪	63	80
500V	[A]	⓪	⓪	⓪	⓪	⓪	⓪	⓪	⓪	⓪	80	80
690V	[A]	⓪	⓪	⓪	⓪	⓪	16	20	35	50	50	63
Ultimate Short-Circuit Breaking Capacity												
I_{cu}												
230/240V	[kA]	100	100	100	100	100	100	100	100	100	100	100
400/415V	[kA]	100	100	100	100	100	100	100	100	100	100	50
440/460V	[kA]	100	100	100	100	100	100	100	100	100	10	10
500V	[kA]	100	100	100	100	100	100	100	100	100	10	10
690V	[kA]	100	100	100	100	100	8	6	6	4	4	3
Rated Service Short-Circuit Breaking Capacity												
I_{cs}												
230/240V	[kA]	100	100	100	100	100	100	100	100	100	100	100
400/415V	[kA]	100	100	100	100	100	100	100	100	100	100	15
440/460V	[kA]	100	100	100	100	100	100	100	100	100	10	6
500V	[kA]	100	100	100	100	100	100	100	100	100	10	6
690V	[kA]	100	100	100	100	100	8	6	6	4	4	3

⓪ No backup fuse required.

IEC Performance Data

		Catalog No. KTC7-25H...		Catalog No. KTC7-45H...	
		16A	20A	25A	32A
Rated Operational Current, I_e	[A]	16	20	25	32
Magnetic Release Current	[A]	260	325	416	585
Switching of Standard Three-Phase Motors					
AC-2, AC-3					
230/240V	[kW]	4.0	5.5	6.3	7.5
400/415V	[kW]	7.5	10	11	15
500V	[kW]	10	11	15	20
690V	[kW]	13	17	22	30
Back-up Fuses					
gG, gL, only if $I_{cc} \geq I_{cu}$					
230/240V	[A]	❶	❶	❶	❶
400/415V	[A]	80	100	100	125
440/460V	[A]	80	100	100	125
500V	[A]	80	80	100	125
690V	[A]	63	63	80	100
Ultimate Short-Circuit Breaking Capacity					
I_{cu}					
230/240V	[kA]	100	100	100	100
400/415V	[kA]	100	65	65	65
440/460V	[kA]	50	25	65	65
500V	[kA]	50	25	50	50
690V	[kA]	6	6	10	10
Rated Service Short-Circuit Breaking Capacity					
I_{cs}					
230/240V	[kA]	100	100	100	100
400/415V	[kA]	25	25	50	50
440/460V	[kA]	25	25	50	50
500V	[kA]	25	25	50	50
690V	[kA]	4	4	6	6

❶ No backup fuse required.

IEC Performance Data

		Catalog Number KTV7-25H...									
		1.6A	2.5A	4A	6.3A	10A	16A	20A	25A	29A	32A
Rated Operational Current, I_e	[A]	1.6	2.5	4.0	6.3	10	16	20	25	29	32
Magnetic Release Current	[A]	82	82	82	82	130	208	260	325	402	448
Switching of Standard Three-Phase Motors											
AC-3											
230/240V	[kW]	0.25	0.37	0.75	1.5	2.2	4	5.5	5.5	7.5	7.5
400/415V	[kW]	0.55	0.75	1.5	2.2	4	7.5	10	11	13	15
500V	[kW]	0.75	1.1	2.2	3	6.3	10	11	15	18.5	20
690V	[kW]	~	~	~	~	~	~	~	~	~	~
Back-up Fuses											
gG, gL, only if $I_{cc} \geq I_{cu}$											
230/240V	[A]	⓪	⓪	⓪	⓪	⓪	⓪	⓪	⓪	⓪	⓪
400/415V	[A]	⓪	⓪	⓪	⓪	⓪	⓪	100	100	125	125
440/460V	[A]	⓪	⓪	⓪	⓪	⓪	80	100	100	125	125
500V	[A]	⓪	⓪	⓪	⓪	⓪	80	80	80	100	100
690V	[A]	~	~	~	~	~	~	~	~	~	~
Ultimate Short-Circuit Breaking Capacity											
I_{cu}											
230/240V	[kA]	65	65	65	65	65	65	65	65	65	65
400/415V	[kA]	65	65	65	65	65	65	65	65	50	50
440/460V	[kA]	65	65	65	65	65	50	50	50	25	25
500V	[kA]	65	65	65	65	65	50	50	50	25	25
690V	[kA]	~	~	~	~	~	~	~	~	~	~
Rated Service Short-Circuit Breaking Capacity											
I_{cs}											
230/240V	[kA]	65	65	65	65	65	65	65	65	50	50
400/415V	[kA]	65	65	65	65	65	50	25	25	25	25
440/460V	[kA]	65	65	65	65	65	50	25	25	20	20
500V	[kA]	65	65	65	65	65	50	25	25	20	20
690V	[kA]	~	~	~	~	~	~	~	~	~	~

⓪ No backup fuse required.

General Data

		KT7-25S/32S	KT7-25H/32H	KT7-45H
Rated Insulation Voltage IEC, SEV, VDE 0660 UL, CSA		690V 600V	690V 600V	690V 600V
Rated Impulse Withstand Voltage (main & auxiliary circuits) U_{imp} /pollution degree		6kV/3	6kV/3	6kV/3
Rated Frequency		50/60 Hz	50/60 Hz	50/60 Hz
Utilization Category • IEC 60949-2 (Motor Protector) • IEC 60949-4-1 (Motor Starter)		A AC-3	A AC-3	A AC-3
Life Span Mechanical Electrical (I_e max.)	[operations] [operations]	100,000 100,000	100,000 100,000	30,000 30,000
Switching Frequency	[operations]	max. 25/h. (motor starts)		
Ambient Temperature Storage Operation		-40° C... +80° C -25° C... +60° C		
Resistance to Climatic Change		IEC 68-2		
Moisture / Heat Resistance	(60068-2-3)	40°C, 93% relative humidity, 56 days		
Moisture / Change Resistance	(60068-2-3)	23°C, 83% relative humidity / 40°C, 92%, 56 cycles		
Dry Heat	(60086-2-2)	100°C Relative Humidity <50% 7 Days		
Site Altitude		to 2,000 m N.N.		
Protection Class		KT 7-25/32 : IP2X from all directions KT 7-45: IP2X from front with front (upper) terminal wired		
Resistance to Shock	(60068-2-2)	30 G, 11 ms All Axes		
Resistance to Vibration	(60068-2-6)	5G		
Rated Thermal Current I_{th} IEC, SEV, VDE 0660 Up to 60° C ambient temperature	[A]	0.1...32	1.6...32	6.3...45
Dependence on Temperature		40°C - 60°C No Reduction 70°C 15% Reduction of the upper rated current I_e		
Overload Protection Characteristics Ambient temperature Compensation Phase-failure protection Trip Class		IEC60947-4-1 Motor protection (except KTB7) -20° C... +60° C yes, differential release 10 (Except KTB7) fixed setting		
Magnetic Release Response Current (+/- 20%)		13...14 x I_e max. (for KTA7/KTB7) 16...21 x I_e max. (for KTC7) I_e max. = maximum values of setting ranges Fixed magnetic setting for KTV7, see ratings		
Total Power Loss P_v Motor protector at rated load Operating temperature	[W]	6...11.5	6...11.6	9...16
Application Conditions (KTV7)		PWM frequency ≤ 4kHz VFD output frequency ≤ 400 Hz		

Weights

Description	Catalog Number	Weight	Description	Catalog Number	Weight
Motor Protectors	KTA7-25S/32S	317 g	Lockable Twist Knob	KT7-KN1	5 g
	KTA7-25H/32H	373 g		KT7-KRY1	
	KTA7-45H	782 g	Locking Tag	KT7-DS	30 g
	KTB7-25S/32S	315 g		KT7-HTN	
	KTB7-25H/32H	365 g	Door Coupling Handle	KT7-HTRY	123 g
	KTB7-45H	782 g		KT7-HT	
	KTC7-25S/32S	315 g	Extension Shaft	KT7-HT	46 g
	KTC7-25H/32H	365 g	Legend Plate	KT7-HTFC	4 g
	KTC7-45H	782 g	Feeder Terminal	KT7-32-A3E	172 g
	KT7-PE1	10 g		KT7-45-A3E	
Auxiliary Contacts	KT7-PA1	10 g	KT7-32-DB-45-2	47 g	
	KT7-PEF1	15 g	KT7-32-DB-45-3	80 g	
	KT7-PAF1	15 g	KT7-32-DB-45-4	104 g	
Undervoltage Trip	KT7-UA-*	108 g	KT7-32-DB-45-5	132 g	
	KT7-AA-*	110 g	KT7-32-DB-54-2	52 g	
	KT7-UA-L20-*	116 g	KT7-32-DB-54-3	86 g	
Anti-Tamper Cover	KT7-25-CA	2 g	KT7-32-DB-54-4	118 g	
			KT7-32-DB-54-5	154 g	

General Data



KT_7-25S/32S



KT_7-25H/32H



KT_7-45H

Features and Approvals

Max. Current I_n	32 A	32 A	45 A
Current Rating	0.1...32 A	1.6...32 A	6.3...45 A
Short Circuit Protection	✓	✓	✓
Standard magnetic Trip	✓	✓	✓
High Magnetic Trip	✓	✓	✓
Magnetic Only Trip (MCP)	✓	✓	✓
Overload Protection	✓	✓	✓
Trip Class	✓	✓	✓
Application at output of VFD (multi-motor)		✓ (KTV7)	✓

Standards Compliance:

CSA22.2, No. 14	✓	✓	✓
UL508 (Group Installation)	✓ (see ratings)	✓ (see ratings)	✓ (see ratings)
UL508 Manual, Self-protected (Type E)	✓ (see ratings)	✓ (see ratings)	✓ (see ratings)
UL508 (Overload Protection)	✓	✓	✓
IEC60947-1,-2	✓	✓	✓
IEC60947-4-1	✓	✓	✓
CE	✓	✓	✓
ATEX (IEC60079-14)	✓ (up to 25 A)	✓ (up to 25 A except KTV7)	✓
CCC	✓ (up to 25 A)	✓ (up to 25 A except KTV7)	✓

Accessories

External Rotary Operator	✓	✓	✓
Auxiliary Contacts	✓	✓	✓
Trip Indicator Contacts	✓	✓	✓

KT_7-25S/32S

KT_7-25H/32H

KT_7-45H

Power Terminals

Terminal Type



Screwdriver

Pozidrive No. 2/Blade No. 3

Pozidrive No. 2/Blade No. 3

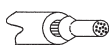

1 conductor

[mm²]/[AWG]

1...6 / No. 16...10

2.5...16 / No. 14...4



2 conductor

[mm²]/[AWG]

1...4 / No. 16...10

2.5...10 / No. 14...4



1 conductor

[mm²]/[AWG]

1.5...6 / No. 16...8

2.5...16 / No. 14...4



2 conductor

[mm²]/[AWG]

1.5...6 / No. 16...8

2.5...10 / No. 14...4



1 conductor

[mm²]/[AWG]

1...6 / No. 16...10

2.5...10 / No. 14...8



2 conductor

[mm²]/[AWG]

1...6 / No. 16...10

2.5...10 / No. 14...8





Tightening torque

[Nm]/[lb-in.]

2...2.5 / 18...22

3...3.5 / 27...30

Accessories for KT7 Motor Circuit Controllers

		Auxiliary Contact Blocks for Front Mounting Catalog Number KT7-PE1, KT7-PEF1			Auxiliary Contact Blocks for Right-Side Mounting Catalog Number KT7-PA1, KT7-PAF1					
IEC Rated Thermal Current I_{th}			300 max.			600 max.				
Rated Voltage	[V]									
at 40°C ambient temperature	[A]		5			10				
at 60°C ambient temperature	[A]		4			6				
UL/CSA Rated Thermal Current I_{th}			300 max.			600 max.				
Rated Voltage	[V]									
Continuous Thermal Current		Class	Amps		Class	Amps				
According to NEMA ①	AC	B 300	5		B 600	5				
	DC	Q 300	2.5		Q 600	2.5				
Back-Up Fuses gG, gL		[A]	10			10				
Rated Thermal Current I_{th}										
AC-15	[V]	24	120	240	24	120	240	415	690	
	[A]	4	3	1.5	6	5	3	2		0.7
DC-13	[V]	24	120	240	24	120	240	415		
	[A]	2	0.5	0.25	2	0.5	0.25	0.15		
Terminal Parts										
Terminal Type										
Screwdriver			Pozidrive No. 2/Blade No. 3			Pozidrive No. 2/Blade No. 3				
	1 conductor	[mm²]/[AWG]	0.5...1.5 / No. 18...14		0.5...2.5 / No. 18...14					
	2 conductor	[mm²]/[AWG]	0.75...1.5 / No. 18...14		0.75...2.5 / No. 18...14					
	1 conductor	[mm²]/[AWG]	0.75...1.5 / No. 18...14		0.75...2.5 / No. 18...14					
	2 conductor	[mm²]/[AWG]	0.75...1.5 / No. 18...14		0.75...2.5 / No. 18...14					
	1 conductor	[mm²]/[AWG]	0.75...1.5 / No. 18...14		0.75...2.5 / No. 18...14					
	2 conductor	[mm²]/[AWG]	0.75...1.5 / No. 18...14		0.75...2.5 / No. 18...14					
Tightening torque		[Nm]/[lb-in.]	1.2...1.5 / 10.6...13			1.2...1.5 / 10.6...13				
Lockable Twist Knob (KT7-KN1 & KT7-KRY1)										
Tightening torque		[Nm]/[lb-in.]				1 / 8.8 (T10)				
Mounting Depth – Door Coupling Handles (All KT7-HT...)										
Mounting Depth when using motor circuit controller:										
	KT7-25S/32S	[mm]/[in.]	105.5 mm ± 5 mm (4.15" ± 3/16")							
	KT7-25H/32H	[mm]/[in.]	114.5 mm ± 5 mm (4.5" ± 3/16")							
	KT7-45H	[mm]/[in.]	137.1 mm ± 5 mm (5.4" ± 3/16")							
Mounting Depth – Extension Shaft (KT7-HT)										
Mounting Depth range when using motor circuit controller:										
	KT7-25S/32S	[mm]/[in.]	117...338 mm (4.6"...13.3")							
	KT7-25H/32H	[mm]/[in.]	126...347 mm (5.0"...13.7")							
	KT7-45H	[mm]/[in.]	149...369 mm (5.9"...14.5")							





① See page A7 for details of NEMA Contact Class.



KT7 Accessories

		Undervoltage Trip for Left-Side Mounting Cat. Number KT7-UA-*	Undervoltage Trip with 2 Auxiliary Contacts for Left-Side Mounting Cat. Number KT7-UA-L20-*	Shunt Trip for Left-Side Mounting Cat. Number KT7-AA-*
Actuating Voltage	Pull-in	$0.85 \dots 1.1 \times U_s$	$0.85 \dots 1.1 \times U_s$	$0.7 \dots 1.1 \times U_s$
	Drop-out	$0.7 \dots 0.35 \times U_s$	$0.7 \dots 0.35 \times U_s$	
Rated Control Voltage	minimum	21V 50 Hz, 24V 60 Hz	21V 50 Hz, 24V 60 Hz	21V 50 Hz, 24V 60 Hz 600V 50 Hz
	maximum	600V 50 Hz	600V 50 Hz	
On-Time		100%	100%	AC - 100% DC - Max. 5 sec.
Coil Rating	Pull-in	8.5 VA, 8 W	8.5 VA, 8 W	8.5 VA, 8 W 4 VA, 2 W
	Hold	4 VA, 2 W	4 VA, 2 W	

Terminal Parts

Terminal Type

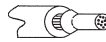
Screwdriver				Pozidrive No. 2/BLADE No. 3
	1 conductor	[mm ²]/[AWG]		0.5...2.5 / No. 18...14
	2 conductor	[mm ²]/[AWG]		0.75...2.5 / No. 18...14
	1 conductor	[mm ²]/[AWG]		0.75...2.5 / No. 18...14
	2 conductor	[mm ²]/[AWG]		0.75...2.5 / No. 18...14
	1 conductor	[mm ²]/[AWG]		0.75...2.5 / No. 18...14
	2 conductor	[mm ²]/[AWG]		0.75...2.5 / No. 18...14
Tightening torque		[Nm]/[lb-in.]		1.2...1.5 / 10.6...13.3



Rated Thermal Current I_{th} at 60° C ambient temperature		[V] [A]	Feeder Block	Feeder Terminal	Compact Busbar	Feeder Terminal	Compact Busbar
			KT7-25-A2E	KT7-32-A3E	KT7-32-DB...	KT7-45-A3E	KT7-45-DB...
			600	600	600	600	600
			64	64	64	120	120
	1 conductor	[mm ²]/[AWG]	4...25/No. 10...4	2.5...25/No. 14...4	~	4...50/12...1/0	~
	1 conductor	[mm ²]/[AWG]	4...25/No. 10...4	2.5...25/No. 14...4	~	2.5...50/12...1/0	~
	1 conductor	[mm ²]/[AWG]	2.5...25/No. 14...4	2.5...25/No. 14...4	~	2.5...50/12...1/0	~
	1 conductor	[mm ²]/[AWG]	14...4	14...4	~	5...6/45...54	~
Tightening torque		[Nm]/[lb-in.]	3...3.5 / 27...31	3...3.5 / 27...31	~	5...6/45...54	~

KF7 Fuse Holder Accessories

		KF7 Fuse Holder	
Rated Thermal Current I_{th} at 60° C ambient temperature	[V]	600	
	[A]	30	
Short Circuit			
Withstand	[KA]	200	
U_{imp}	[KV]	6	

Terminal Parts

Terminal Type

Screwdriver				Pozidrive No. 2/ Blade No. 3
	1 conductor	[mm ²]/[AWG]		1...4 / No. 16...10
	1 conductor	[mm ²]/[AWG]		1...4 / No. 16...10
Tightening torque		[Nm]/[lb-in.]		1.7 / 15

Time-Current Characteristic

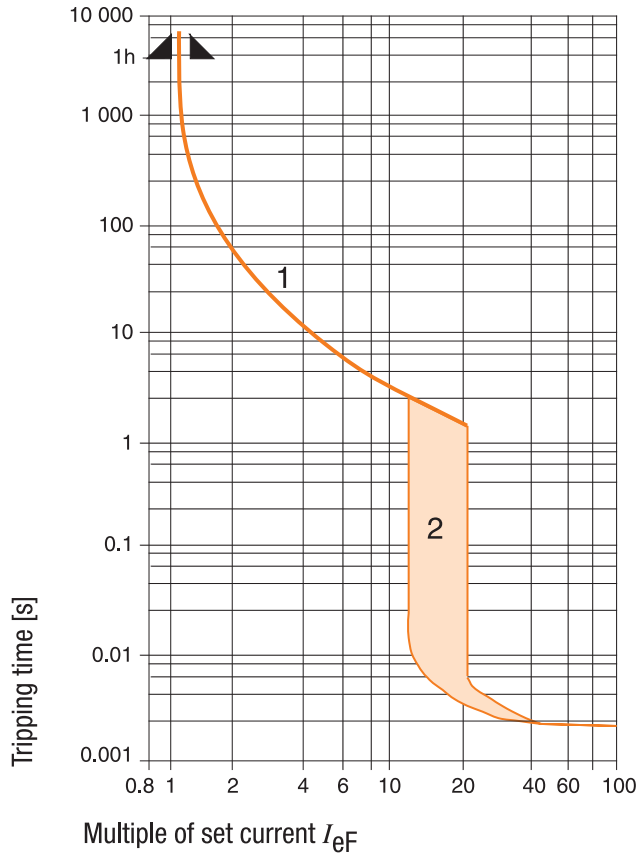

KTA7 Motor Protection (for KTV7, see ratings)

1. Thermal Release Trip Current

The adjustable current-dependent delayed bimetal release protects motors against overload. The curve shows the mean operating current at an ambient temperature of 20°C starting from the cold state. Careful testing and setting ensures effective motor protection even in the case of single-phasing. The overload characteristic is also valid for transformer protection.

2. Magnetic Release Trip Current

The instantaneous magnetic trip has a fixed operating current setting. This corresponds to 13 times the maximum value of setting range (high inrush protection -20 x I_e maximum). At a lower overload setting the magnetic trip is correspondingly higher.

Current Setting I_{ef}

The overload trip corresponds to a thermal overload relay in a motor starter conforming to IEC 947-4-1. If a different value is prescribed (e.g., reduced I_e for cooling medium having a temperature higher than 40°C or a place of installation higher than 2000m above sea level), the setting current is equal to the reduced rated current I_e of the motor.

Cut-off Current ①

KT A/B/C7-25/32S
Max. Cut-Off-Current, $U_e = 500V$

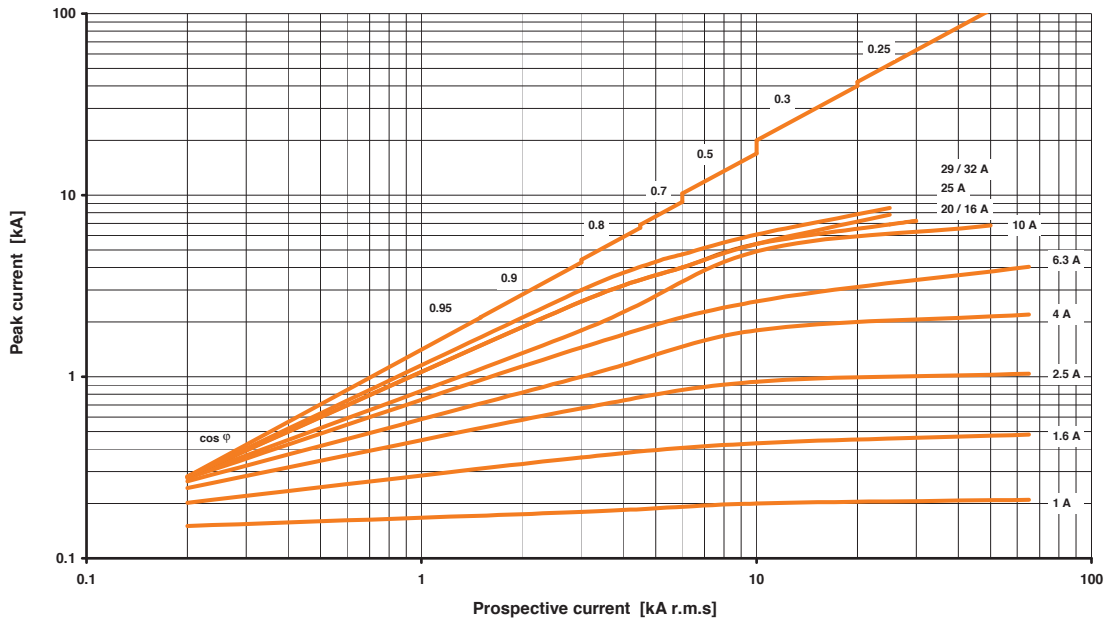

KT A/B/C7-25/32H
Max. Cut-Off Current, $U_e = 500V$

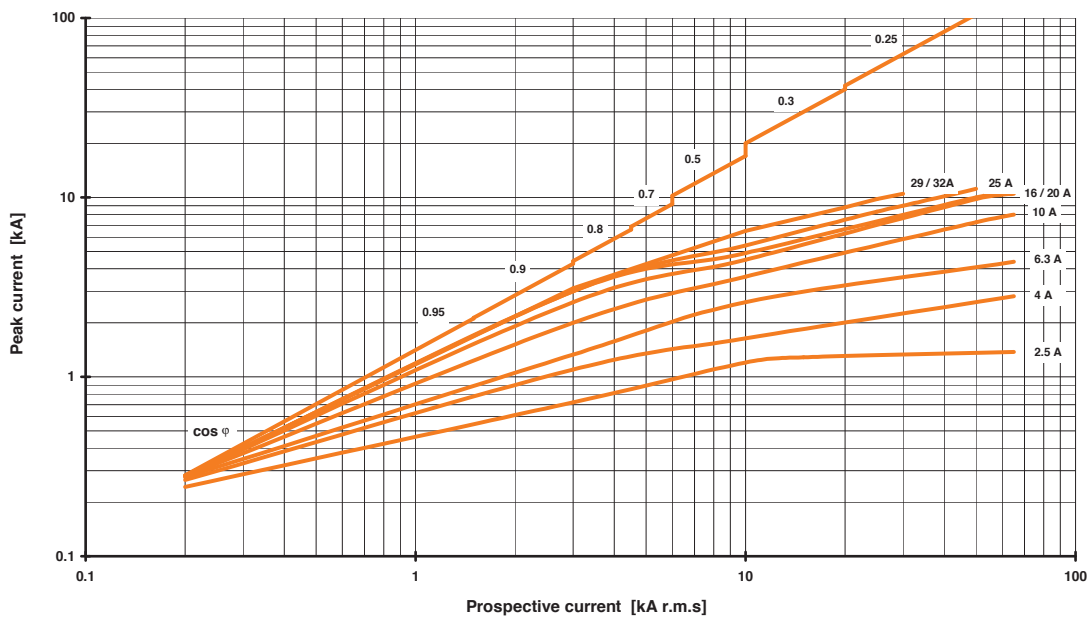

① A full size (8-1/2 x 11) set of "Maximum Cut-Off Current (Let-Thru Current)" and "Maximum Let-thru Energy (I²t)" curves for 400...415V, 500V and 690V can be downloaded from <http://www.sprecherschuh.com>.

Cut-off Current ①

KTA/B/C7-45H
Max. Cut-Off Current, $U_e = 500V$

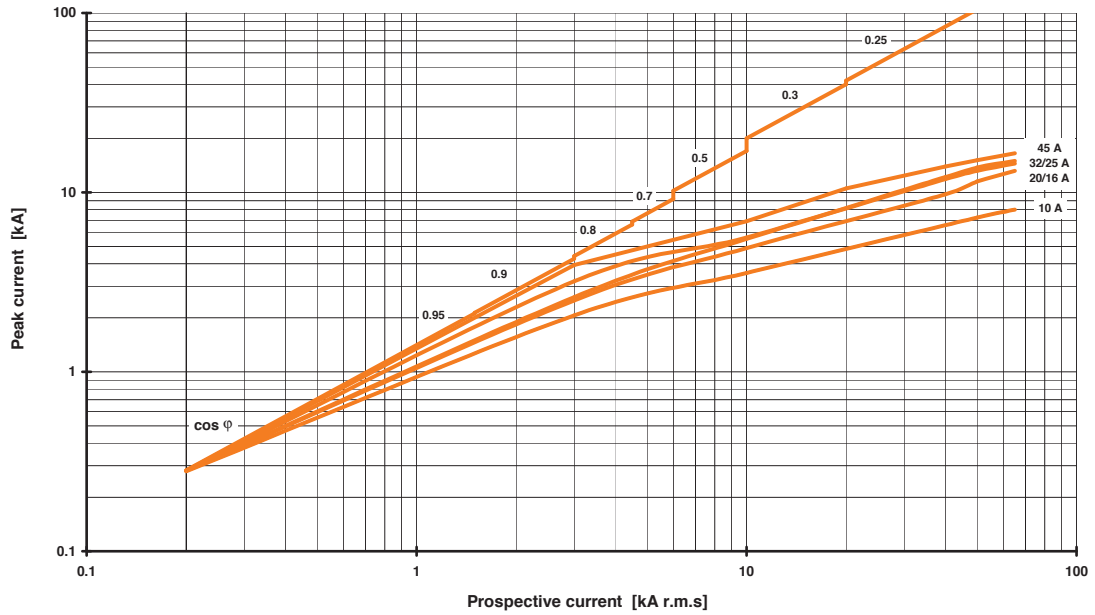

KTV7
Max. Cut-Off Current, $U_e = 400...415V$

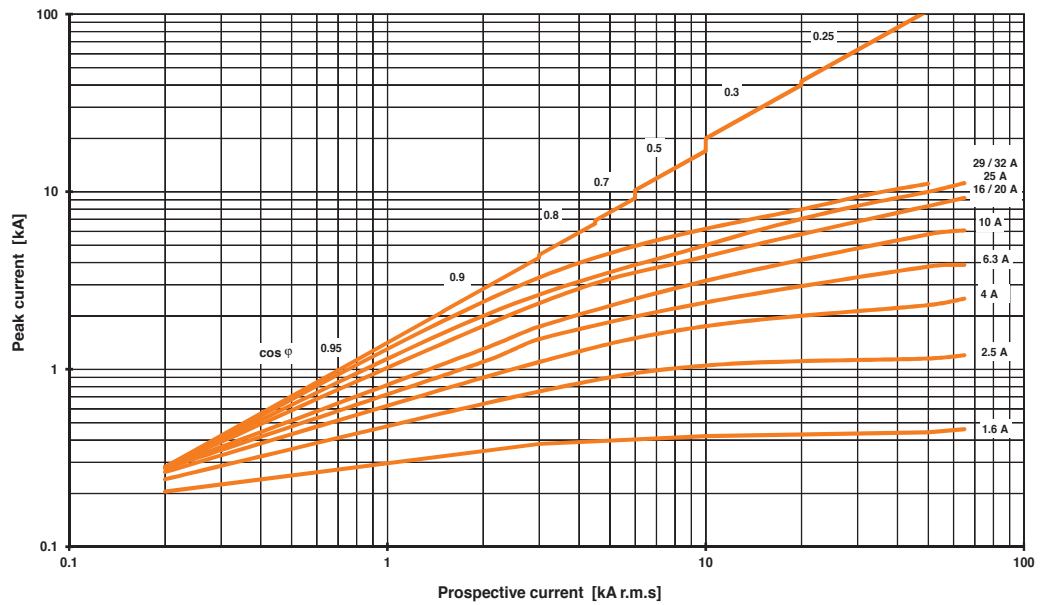

① A full size (8-1/2 x 11) set of "Maximum Cut-Off Current (Let-Thru Current)" and "Maximum Let-thru Energy (I²t)" curves for 400...415V, 500V and 690V can be downloaded from <http://www.sprecherschuh.com>.

Let-Through Energy ①

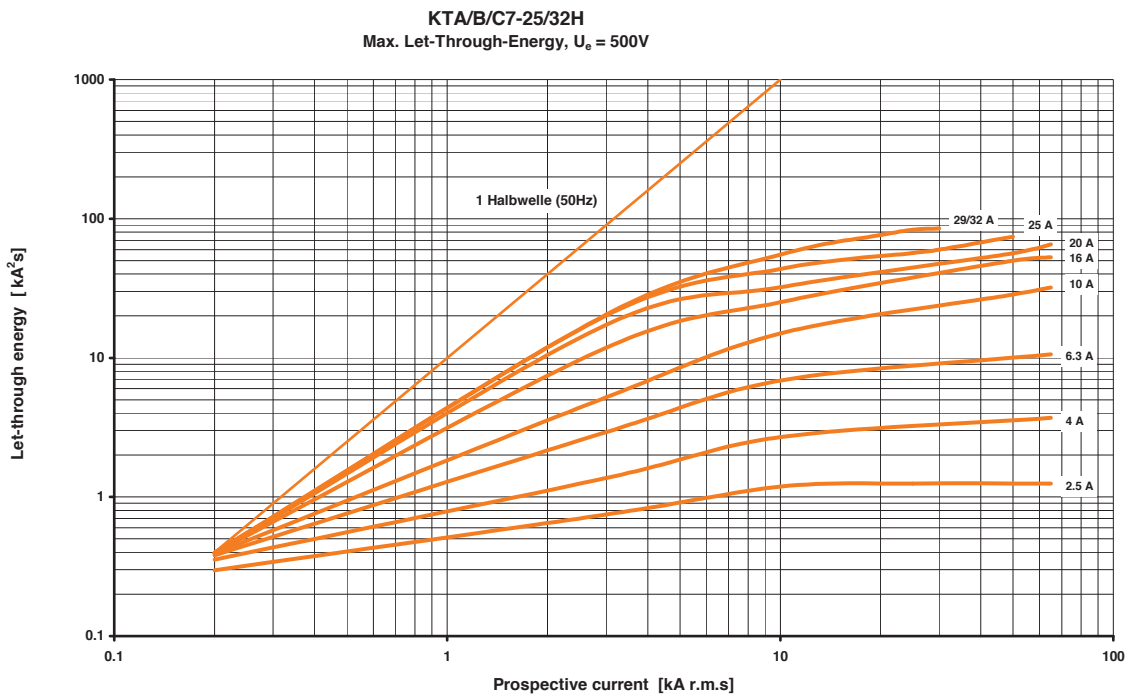
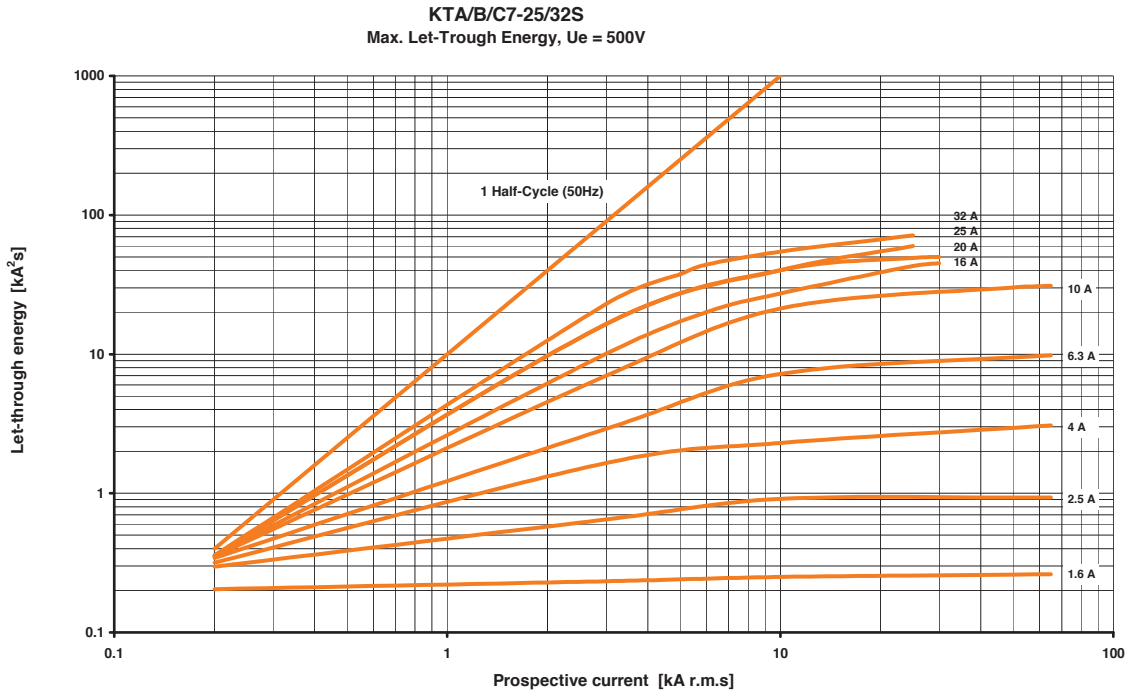

① A full size (8-1/2 x 11) set of "Maximum Cut-Off Current (Let-Thru Current)" and "Maximum Let-thru Energy (I^2t)" curves for 400...415V, 500V and 690V can be downloaded from <http://www.sprecherschuh.com>.

Let-Through Energy ①

KTA/B/C7-45H
Max. Let-Through-Energy, $U_o = 500V$

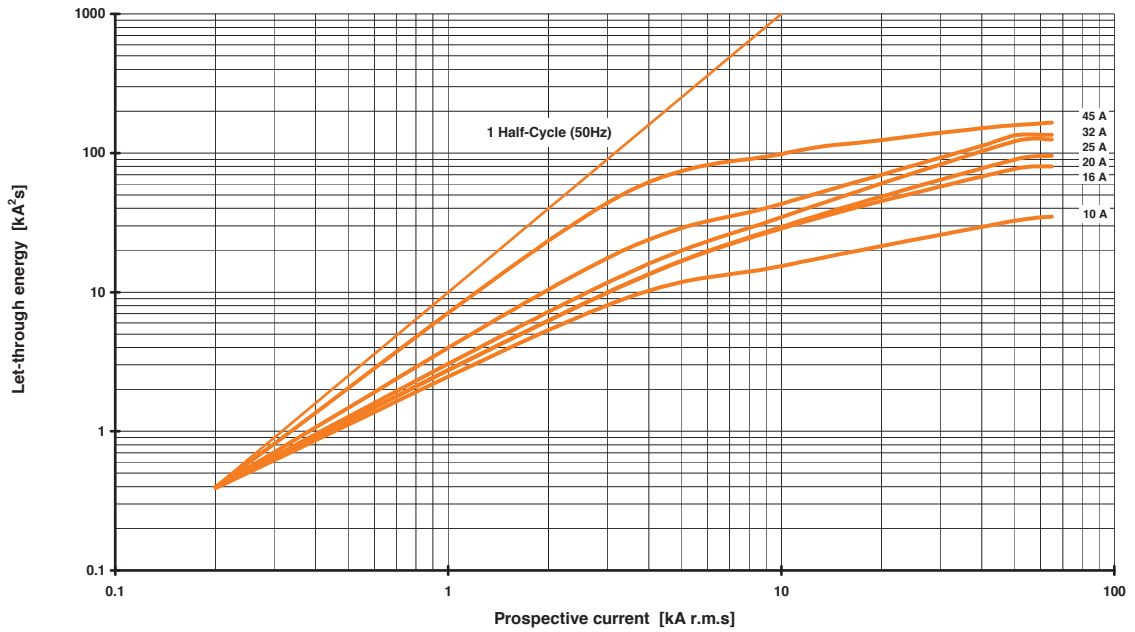

KTV7
Max. Let-Through-Energy, $U_o = 400... 415V$

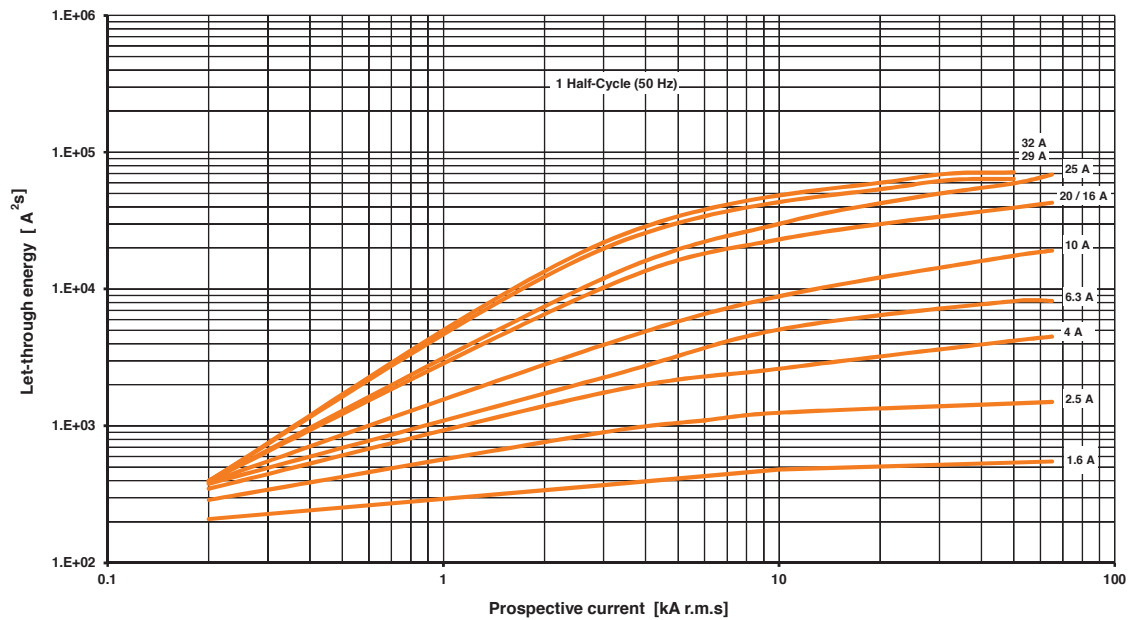

① A full size (8-1/2 x 11) set of "Maximum Cut-Off Current (Let-Thru Current)" and "Maximum Let-thru Energy (I²t)" curves for 400...415V, 500V and 690V can be downloaded from <http://www.sprecherschuh.com>.

KTA7/KTB7 & KTC7 Bus Bar and Supply Blocks

Dimensions are in millimeters (inches). Dimensions not intended for manufacturing purposes.

KT7-32-A3E

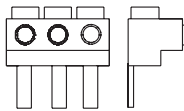

KT7-45-A3E

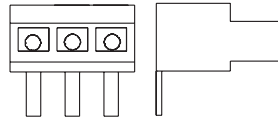

KT7-32-DB

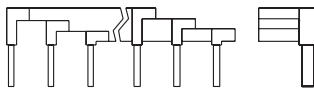

KT7-45-DB

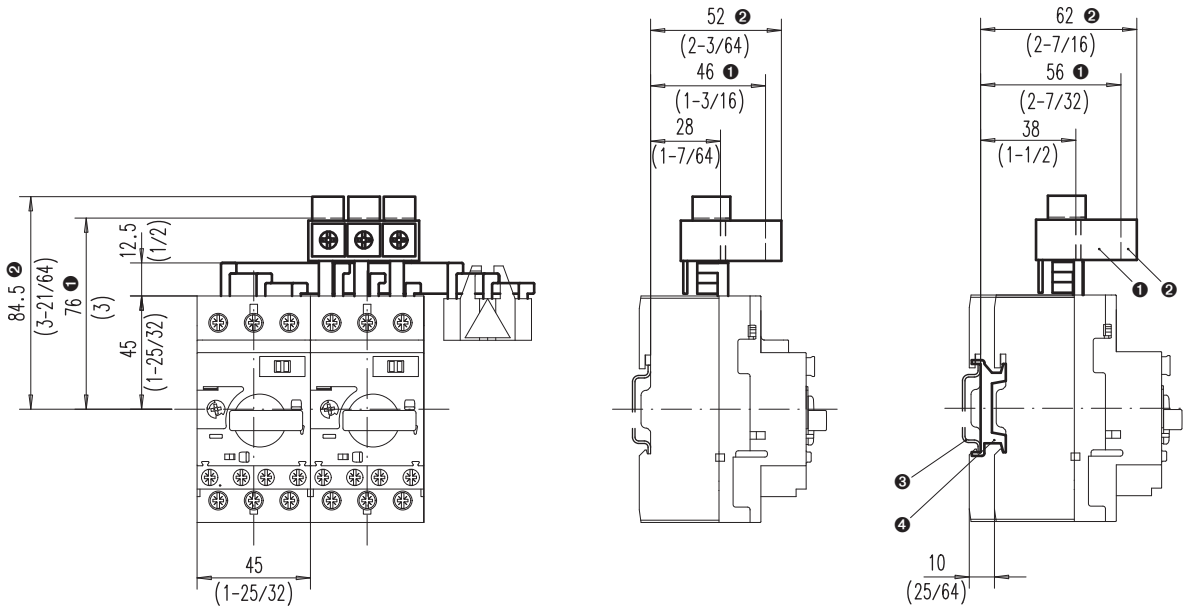
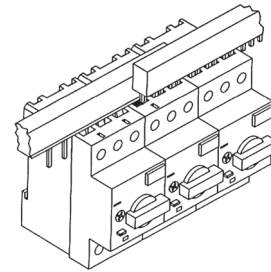
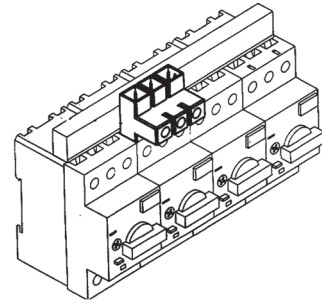
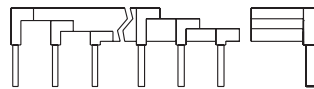

- ❶ Compact Busbar Feeder Terminal IEC
- ❷ Compact Busbar Feeder Terminal UL type E and IEC
- ❸ Mounting on 35 mm DIN Rail
- ❹ Top Hat Rail Adapter 10 mm

KT_7-25/32 Motor Circuit Controllers (without Terminal Adaptor KT7-25-TE1)

Dimensions are in millimeters (inches). Dimensions not intended for manufacturing purposes.

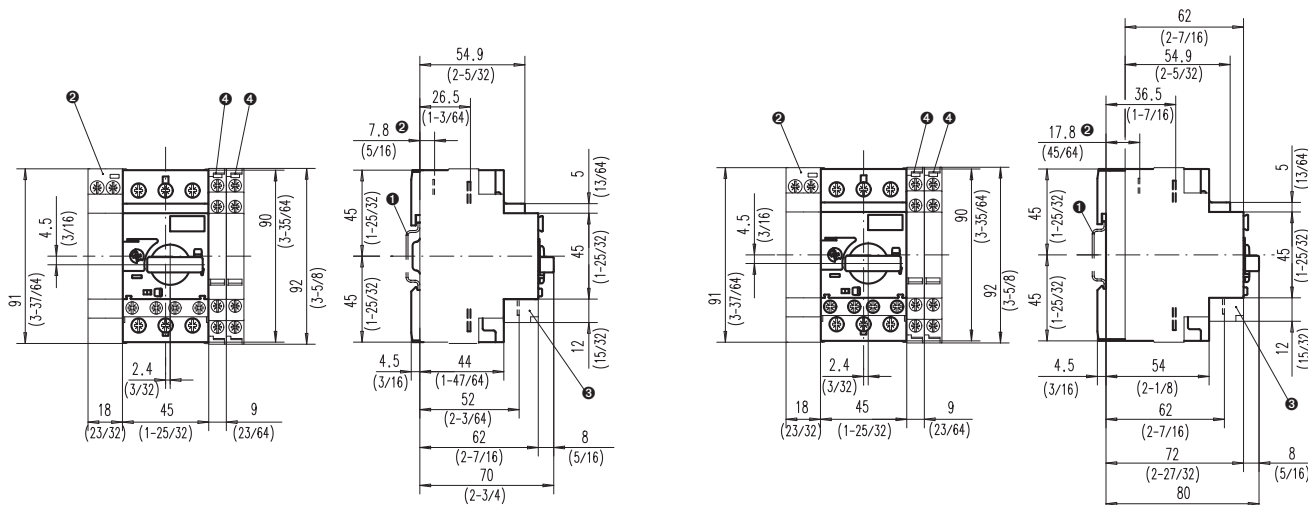

- 1 Mounting on 35 mm DIN rail
- 2 Undervoltage/shunt trip
- 3 Auxiliary contact (front mounted)
- 4 Auxiliary contact (side mounted)

KT_7-25/32 Motor Circuit Controllers (with Terminal Adaptor KT7-25-TE1)

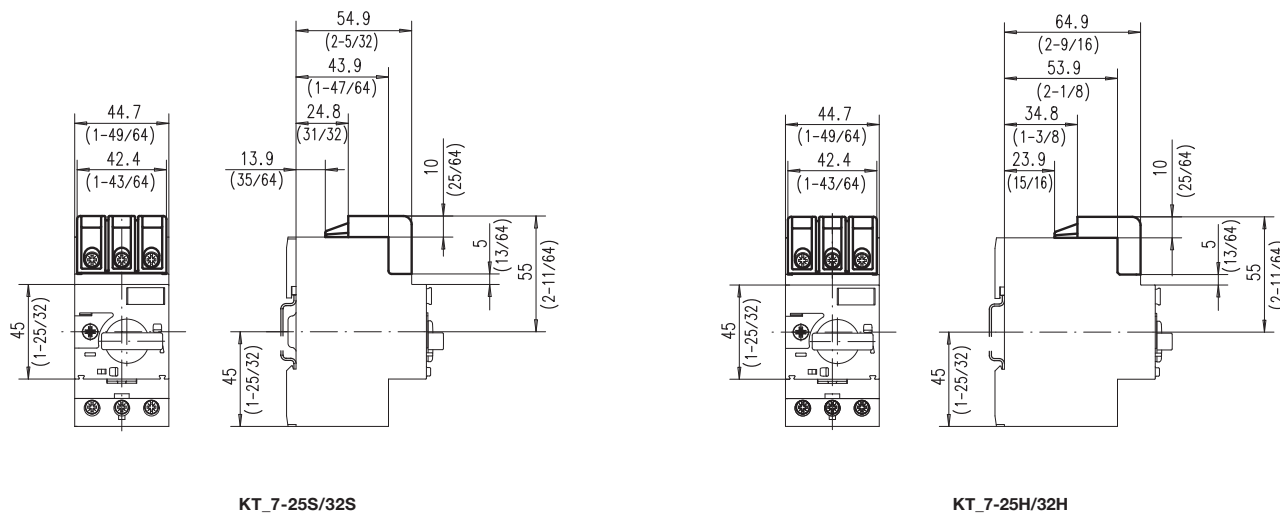

KT_7-45H Motor Circuit Controllers (without Terminal Adaptor KT7-45-TE)

Dimensions are in millimeters (inches). Dimensions not intended for manufacturing purposes.

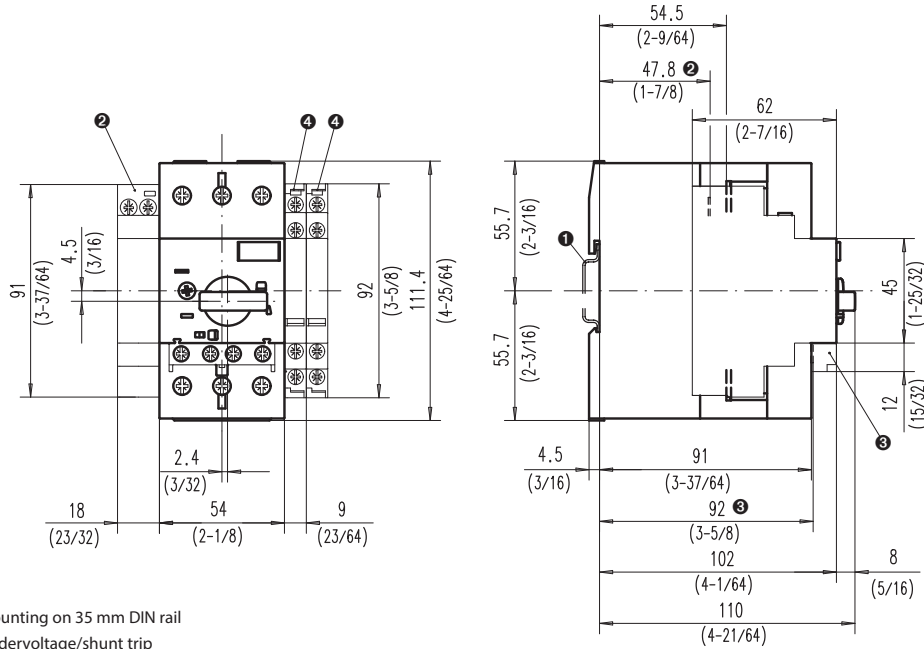

- ❶ Mounting on 35 mm DIN rail
- ❷ Undervoltage/shunt trip
- ❸ Auxiliary contact (front mounted)
- ❹ Auxiliary contact (side mounted)

KT_7-45H

KT_7-45H Motor Circuit Controllers (with Terminal Adaptor KT7-45-TE)

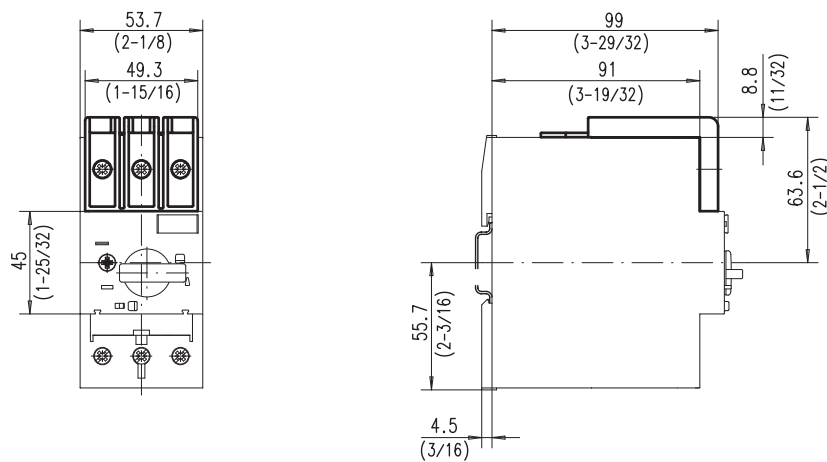

KT_7-45H

KTV7-25/32 Motor Circuit Controllers

Dimensions are in millimeters (inches). Dimensions not intended for manufacturing purposes.

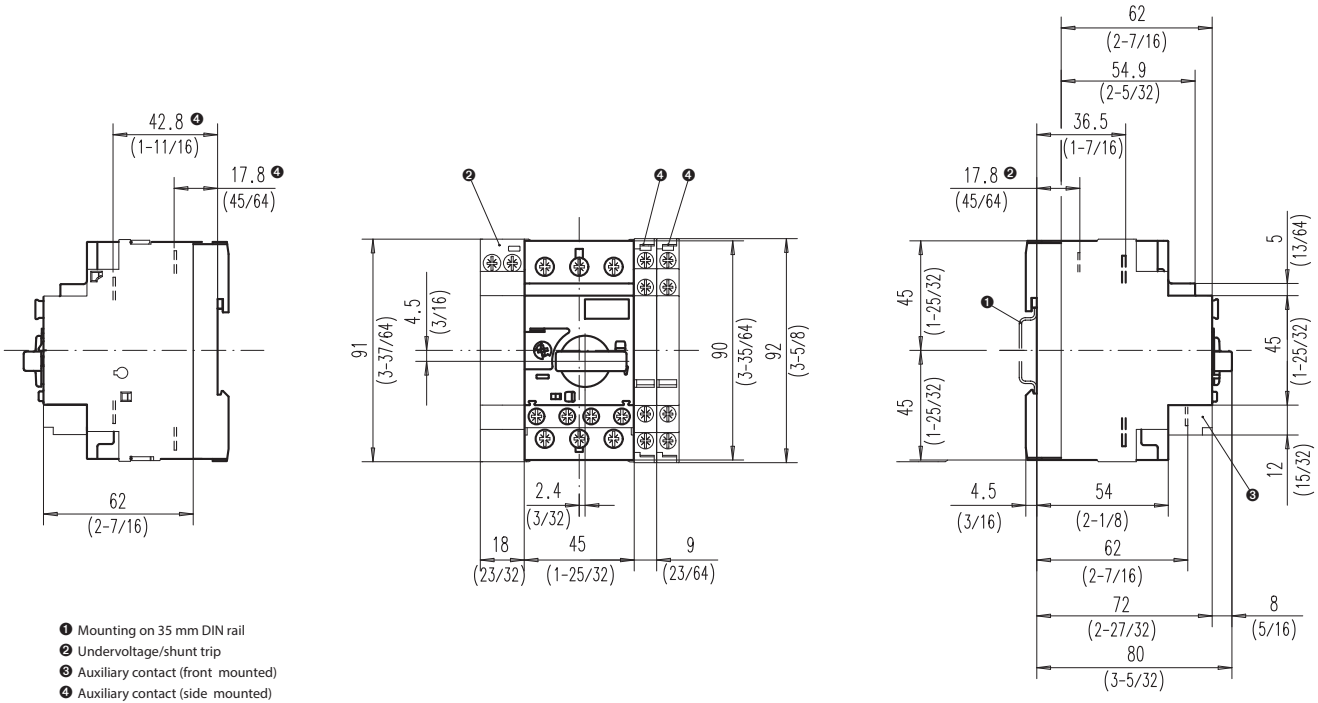

Minimum distance to grounded parts or walls

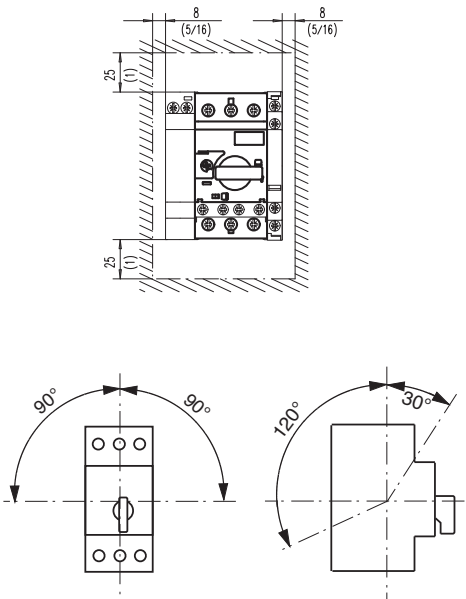

KT7-TE1 Type E adapter on KTV7

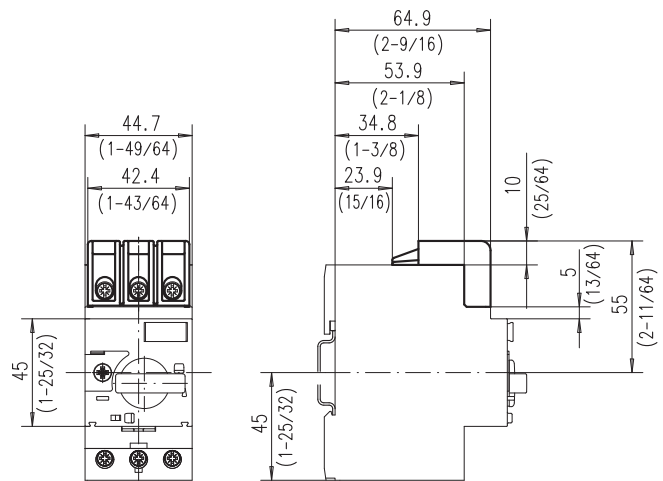

KT7 Motor Circuit Controllers Mounting/Safety Clearance

Dimensions are in millimeters (inches). Dimensions not intended for manufacturing purposes.

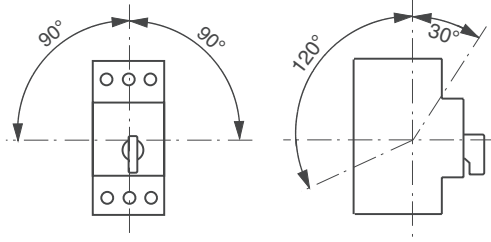

① Minimum distance to grounded parts or walls

KT_7-25/32

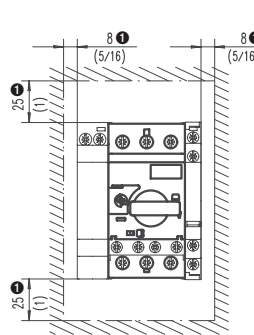

KT_7-45H

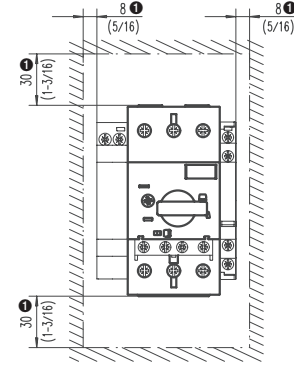

KT7-45-AS Screw Adapter

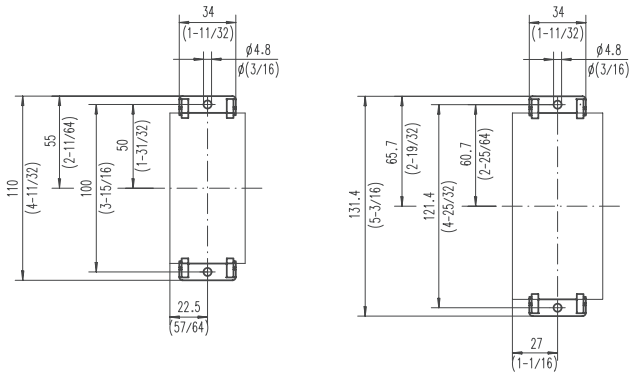

KT7-25-A2E Terminal Block

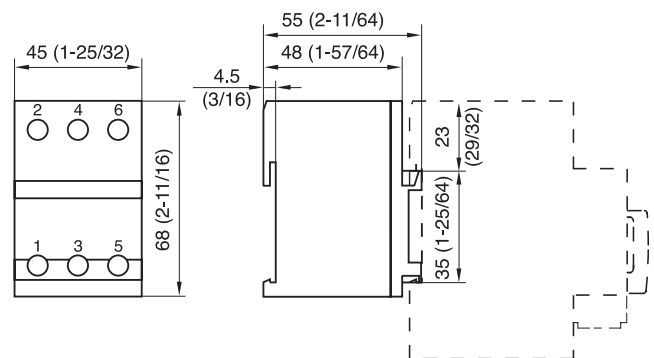

Mounting Position KT7, KTU7

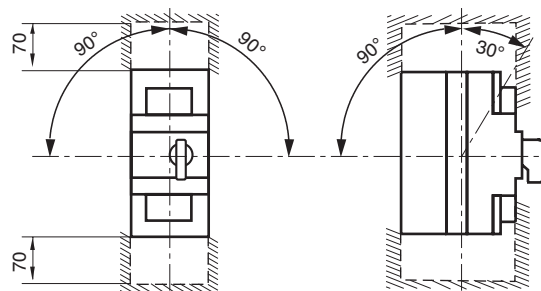

Mounting position/safety clearance

KT7-HTN/HTRY Motor Circuit Controller Door Coupling Handle

Dimensions are in millimeters (inches). Dimensions not intended for manufacturing purposes.

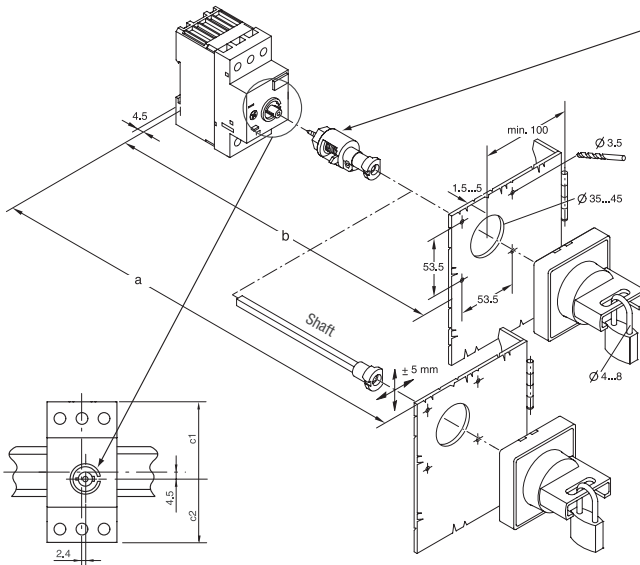

KT7-HTC Coupling is included in Door Handle Kits KT7-HTN and KT7-HTRY. This coupling replaces the knob shipped as standard on the controller. Design "D" Door Coupling Handle Kits include an interface for the "Stops" molded into Design "C" KTA7/KTB7/KTC7 Controllers, which inhibits excessive rotation of the handle mechanism. The old Design "C" Door Handle Kits will fit new Design "C" Controllers (shipped in WHITE boxes), but will not take advantage of the "Stops". Design "D" Door Handle Kits are backward compatible.

Shaft Dimensions

	a		b No Shaft	c1	c2
	Includes 250mm Shaft KT7-HT	Includes 400mm Shaft KT7-HTL			
KT7-25S/32S	117...338 (4.6...13.3 in)	117...488 (4.6...19.2 in)	105.5 ± 5	49.5	40.5
KT7-25H/32H	126...347 (5.0...13.7 in)	126...497 (5.0...19.6 in)	114.5 ± 5	49.5	40.5
KT7-45H	148.6...369.6 (5.9...14.5 in)	148.6...519 (5.9...20.4 in)	137.1 ± 5	59.35	50.35

If using KT7-SHS Shaft Support see page F41 for dimensions

KTA7/KTB7/KTC7 with CA7 Connection Modules and Kits

Combo 1)

KT7-25S-PEC23
KT7-25H-PEC23

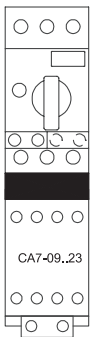

Standard Connection Modules 2)

KT7-25S-PNC23 KT7-25H-PNC23
KT7-25H-PNC37

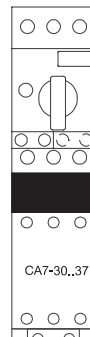
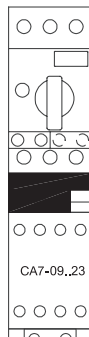

KT7-45H-PNC37

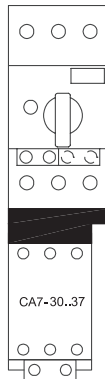

KT7-45H-PNC43

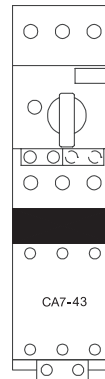

Coil Extension Modules 3)

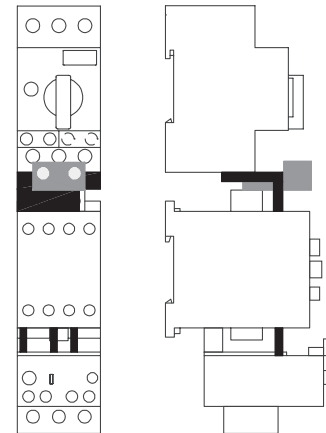

1) Combo Modules

Electrical and mechanical connection between motor circuit controller and contactors with AC coil. For CA7-9...23 only. Compatible with the reversing- and WYE-delta starter components.

2) Standard Connection Modules

Electrical connection between motor circuit controller and contactors with AC coil. For CA7-9...43. Compatible with the reversing- and WYE-delta starter components.

3) Coil Extension Modules

Simplifies access to the coil terminals on 3-component starters.

For CA7-9...23 = **KT7-25S-PSC23**

For CA7-30...43 = **KT7-45H-PSC43**

KT7 Handle Assembly with KT7-SHS Shaft Support

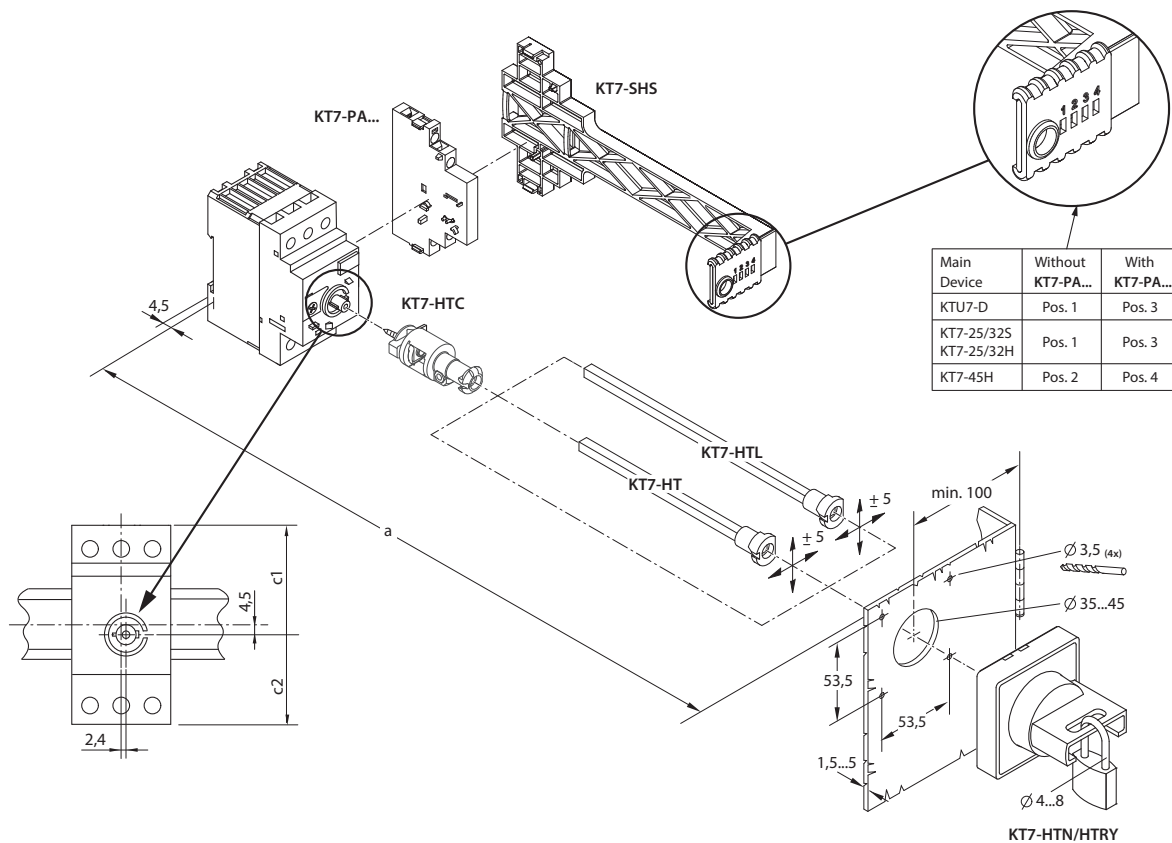

	a KT7-HT	a KT7-HTL	Use KT7-SHS when a >	c1	c2
KT7-25/32S	117...338	117...488	260	49.5	40.5
KT7-25/32H	126...347	127...497	270	49.5	40.5
KT7-45H	148.6...369.6	148.6...519	300	59.35	50.35
KTU7-D	127...348	127...497	270	55.5	46.5

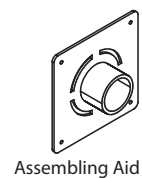

KT7-SHS Shaft Support Dimensions

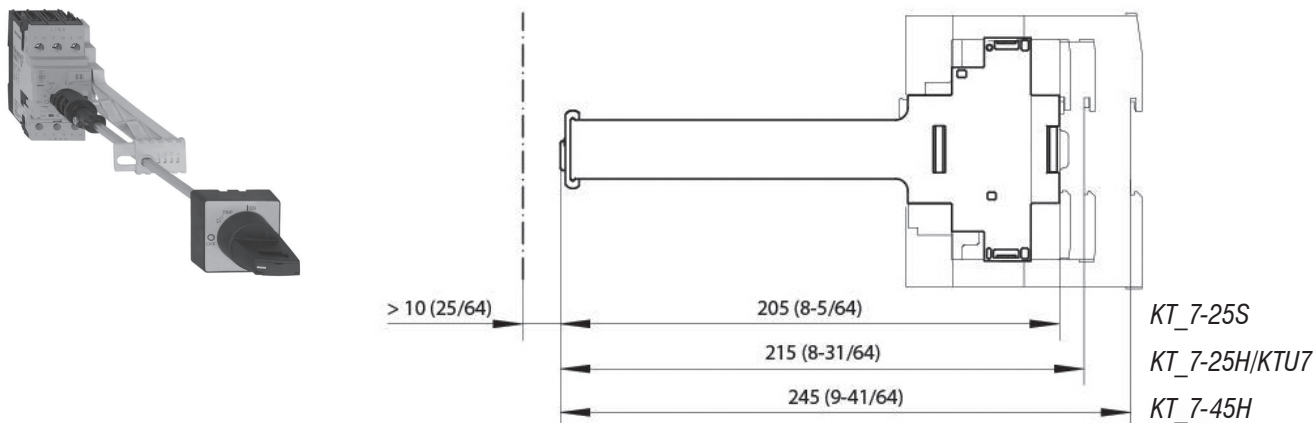

KT7-SY/SB Switch Handle

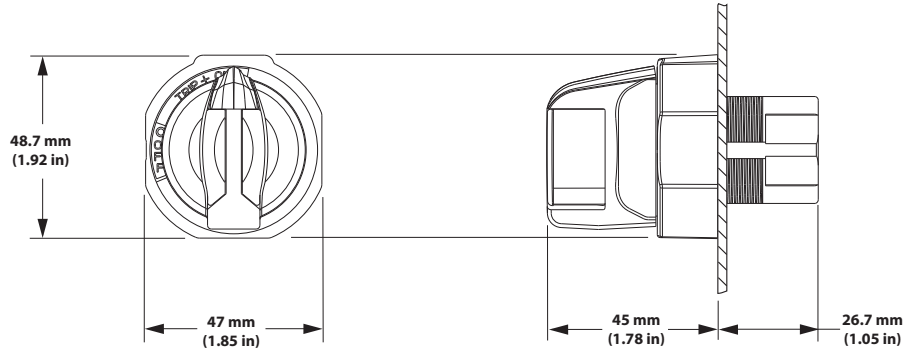

KT7-SY/SB Assembly

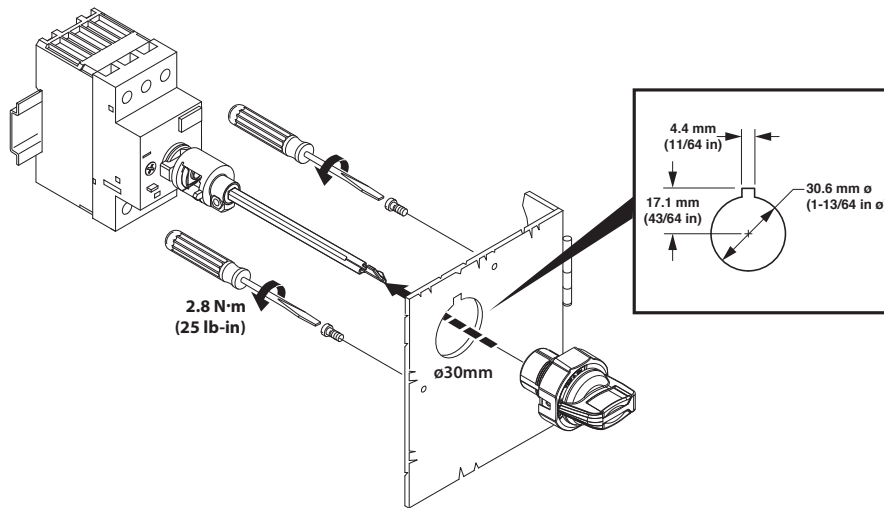

Type W Mounting Modules & Spacer ①

Dimensions are in millimeters (inches). Dimensions not intended for manufacturing purposes.

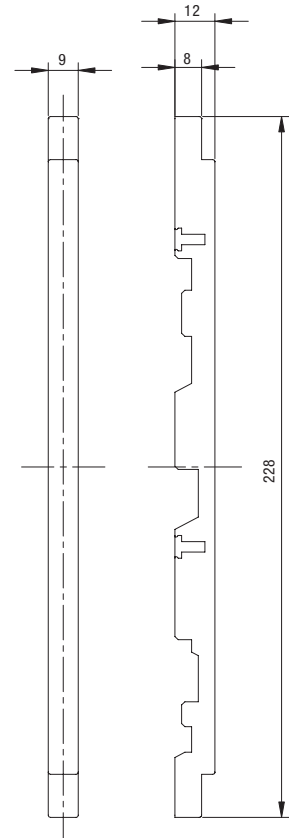
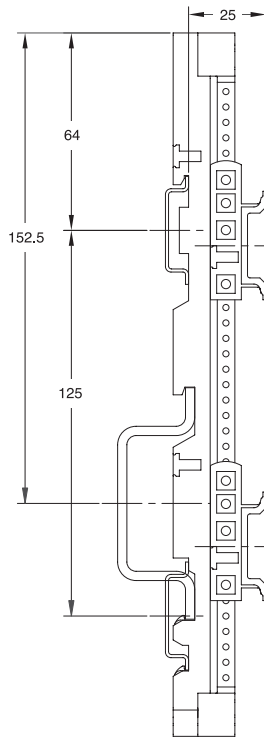
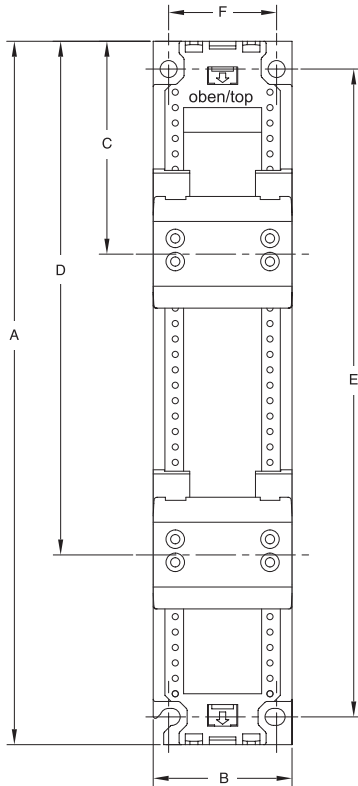

Spacer W-32955

Catalog Number	A	B	C	D	E	F
W-32489	228 (8-31/32)	45 (1-25/32)	69 (2-23/32)	165.5 (6-35/64)	210 (8-17/64)	35 (1-3/8)
W-32490	228 (8-31/32)	54 (2-1/8)	69 (2-23/32)	174 (6-27/32)	210 (8-17/64)	40 (1-37/64)
W-32496	283 (11-9/64)	45 (1-25/32)	69 (2-23/32)	166.5 (6-35/64)	265 (10-7/16)	40 (1-37/64)
W-32497	283 (11-9/64)	54 (2-1/8)	69 (2-23/32)	174 (6-27/32)	265 (10-7/16)	40 (1-37/64)

① Use Pozidriv #1 (PZ1) screwdriver on DIN rail screws.

KF7 Fuse Holders Dimensions

Dimensions are in millimeters (inches). Dimensions not intended for manufacturing purposes.

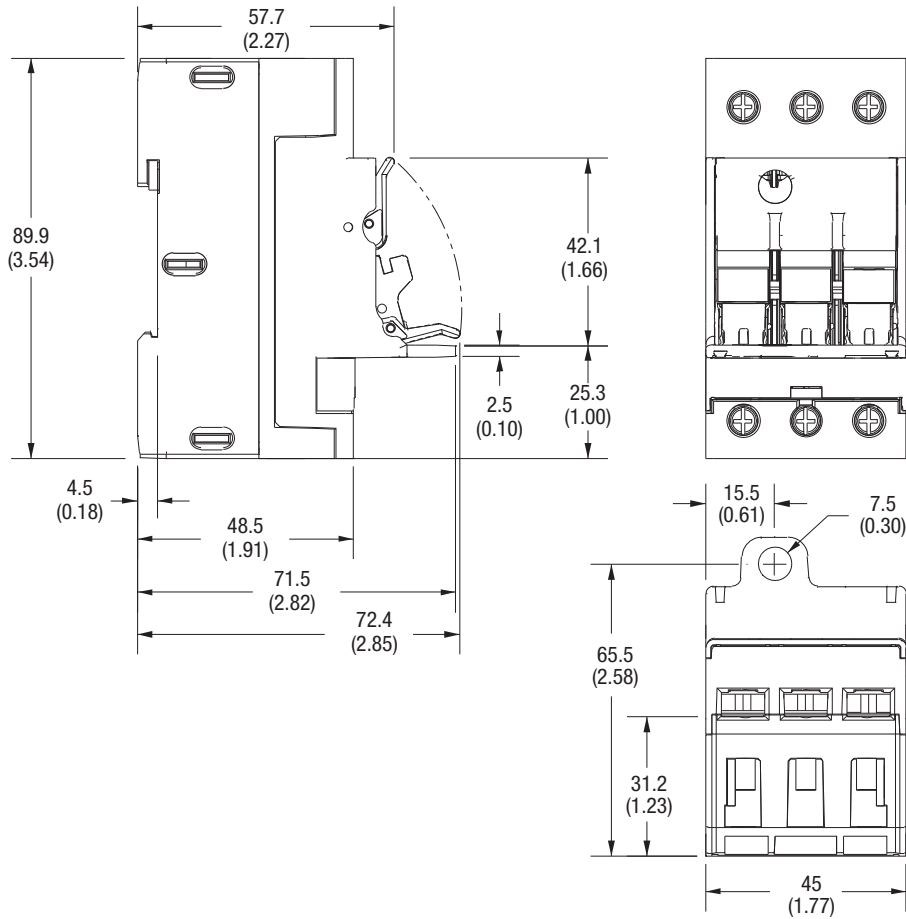

KF7 Fuse Holders Wiring Diagram (IEC)

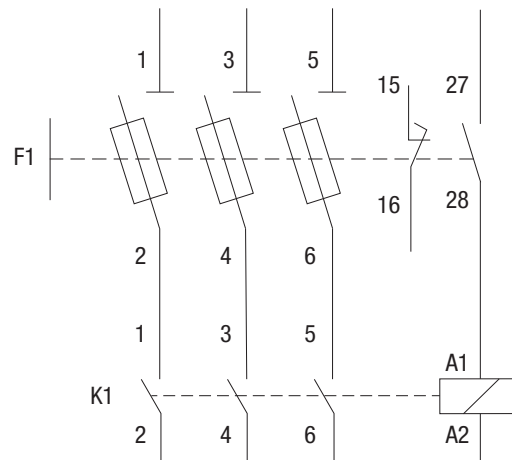

KF7 Fuse Holder used with CA7 Contactor

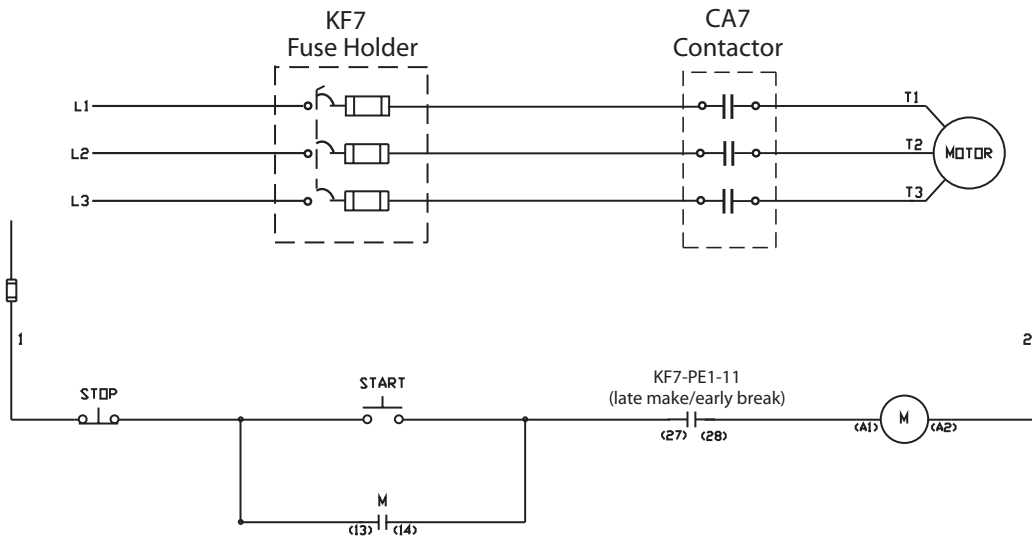

KF7 Fuse Holder used with KTA7 Motor Circuit Controller and CA7 Contactor

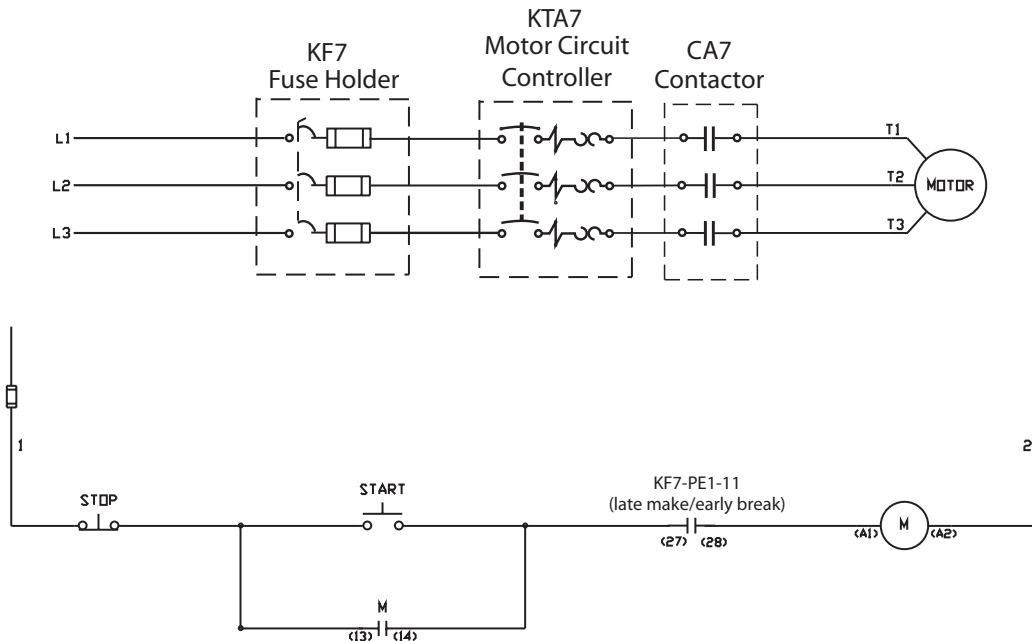

Series KTU7 UL489 Molded Case Circuit Breakers

DISCONTINUED

Sprecher+Schuh's KTU7 series of UL Molded Case Circuit Breakers are UL489 and CE listed for global applications. The current limiting circuit breaker provides fixed short circuit and overcurrent protection and offers high interrupting ratings for 2- and 3-pole devices from 0.5 to 30A. These Circuit breakers are 100% rated up to 10A.

Versatile, convenient and space saving... for a variety of applications

Accessories are intelligently designed to be field installed. The compact busbars and supply blocks reduce wiring errors and installation labor cost. Connection modules for the CA7 Contactors simplify wiring and can reduce the number of DIN rails required, compacting panel space even further.

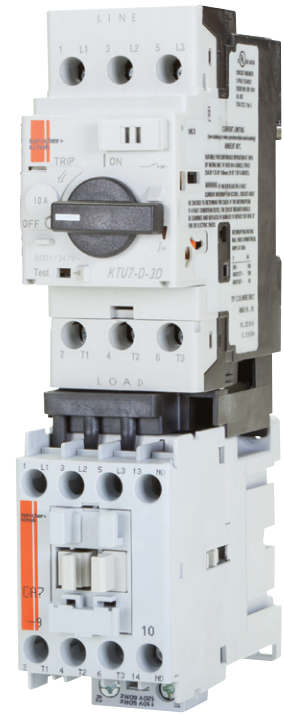

Advantages...

- Small foot print saves panel space, just 45 x 102 x 85 mm, up to 50% smaller than traditional MCCBs.
- Interrupt rating of 65kA at 480Y/277V may allow higher overall panel short circuit rating
- Up to 6 times higher interrupting rating vs. traditional miniature circuit breakers.



Ideal Applications...

- Feeder Circuits for small cabinets, distribution panels, branch circuit protection, transformers and heaters
- Control circuits for control circuit transformers and power supplies
- Industrial Heating applications
- Air conditioning and refrigeration applications

Compare these advanced features



F
KTU7 Molded Case Circuit Breakers

KTU7 Circuit Breaker, Fixed Thermal-Magnetic ②

Fixed Thermal Current Rating [A]	Magnetic Trip [A]	Interrupting Rating (60Hz) [KA]			Catalog Number
		240V	480Y/277V	600Y/347V	
KTU7-D — High Interrupting Capacity – 2-Pole					
0.5	15...20xIn	100	100	50	KTU7-D-2D-0.5 ①
1.0	15...20xIn	100	100	50	KTU7-D-2D-1 ①
2.0	15...20xIn	100	100	50	KTU7-D-2D-2 ①
3.0	15...20xIn	100	100	50	KTU7-D-2D-3 ①
4.0	15...20xIn	100	100	50	KTU7-D-2D-4 ①
5.0	15...20xIn	100	100	50	KTU7-D-2D-5 ①
6.0	15...20xIn	100	100	50	KTU7-D-2D-6 ①
8.0	15...20xIn	100	100	50	KTU7-D-2D-8 ①
10.0	15...20xIn	100	100	50	KTU7-D-2D-10 ①
12.0	15...20xIn	65	65	25	KTU7-D-2D-12
15.0	15...20xIn	65	65	25	KTU7-D-2D-15
20.0	15...20xIn	65	65	25	KTU7-D-2D-20
25.0	15...20xIn	65	65	25	KTU7-D-2D-25
30.0	15...20xIn	65	65 <td 25	KTU7-D-2D-30	
KTU7-D — High Interrupting Capacity – 3-Pole					
0.5	15...20xIn	100	100	50	KTU7-D-3D-0.5 ①
1.0	15...20xIn	100	100	50	KTU7-D-3D-1 ①
2.0	15...20xIn	100	100	50	KTU7-D-3D-2 ①
3.0	15...20xIn	100	100	50	KTU7-D-3D-3 ①
4.0	15...20xIn	100	100	50	KTU7-D-3D-4 ①
5.0	15...20xIn	100	100	50	KTU7-D-3D-5 ①
6.0	15...20xIn	100	100	50	KTU7-D-3D-6 ①
8.0	15...20xIn	100	100	50	KTU7-D-3D-8 ①
10.0	15...20xIn	100	100	50	KTU7-D-3D-10 ①
12.0	15...20xIn	65	65	25	KTU7-D-3D-12
15.0	15...20xIn	65	65	25	KTU7-D-3D-15
20.0	15...20xIn	65	65	25	KTU7-D-3D-20
25.0	15...20xIn	65	65	25	KTU7-D-3D-25
30.0	15...20xIn	65	65	25	KTU7-D-3D-30

Description

The KTU7 is a fixed trip, thermal-magnetic UL489 Molded Case Circuit Breaker.



KTU7-D-2D-10



KTU7-D-3D-10

F

KTU7 Molded Case Circuit Breakers

① Suitable for continuous operation at 100% of rating only if used in minimum enclosure space of 250 x 175 x 150 mm (10 x 7 x 6 in).
 ② KTU7 has independent thermal elements suitable for power distribution applications (not two slide bar differential tripping).

KT7 Accessories available for KTU7-D

	<p>KT7-PE1 or KT7-PEF1 Front Mount Auxiliaries and Trip Contacts See page F12</p>		<p>KT7-KN1, KT7-KRY1 or KT7-DS Lockable Twist Knob & Locking Tag See page F16</p>
	<p>KT7-UA or KT7-AA Undervoltage Trips and Shunt Trips ❶ See page F14</p>		<p>Handle Assemblies KT7-SY or KT7-SB KT7-HTN or KT7-HTRY ❷ See page F15</p>
	<p>KT7-HT/HTL, KT7-S_/N_ & KT7-SHS Extension Shafts & Support See page F15</p>		<p>KT7-45-AS Screw Adaptor See page F16</p>

F

KTU7 Molded Case Circuit Breakers

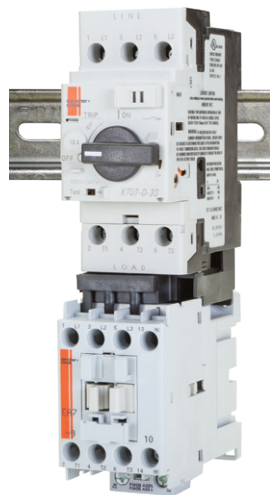

Remote Operation Application

The KTU7 3-Pole unit can be combined with CA7 using Connector Modules to achieve remote operation.

- For CA7-9...23 use KTU7-D-PEC23
- For CA7-9...43 use KTU7-D-PF



Extension Shaft Support Assembly



The KT7-SHS is recommended for handle shafts KT7-HT_ or KT7-S_/N_ in lengths greater than 200mm (7.8 inches).

See page F41

❶ Series B or later.
❷ Series E or later.

DISCONTINUED



Connecting Modules (for connecting KTU7 to CA7 AC coil, or CA7 Electronic DC coil contactors)

Module	Description	For Connecting. . .	To Contactor. . .	Catalog Number
	Connecting Modules <ul style="list-style-type: none"> • 25 Amp maximum • Provides electrical and mechanical interconnection of KTU7 3-Pole and CA7 (with AC coils) or CA7- _E (with 12V or 24V Electronic DC coils) • KTU7 and Contactor mount on one DIN rail (see previous page for visual) 	KTU7-D	CA7-9..23	KTU7-D-PEC23 ❶
	Flexible Connecting Module <ul style="list-style-type: none"> • 32 Amp maximum • Provides electrical and mechanical interconnection of KTU7 and CA7 (with AC coils) or CA7- _E (with 12V or 24V Electronic DC coils) • Contactor and KTU7 separately mounted 	KTU7-D	CA7-9..43	KTU7-D-PF ❶

F

KTU7 Molded Case Circuit Breakers

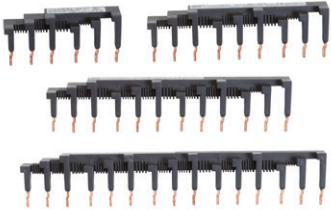
Compact Busbar System for KTU7-D

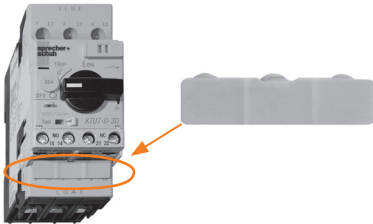
Accessory	Description	For Use With	Catalog Number
	Compact Busbar — 45 mm Spacing (Rated 64 A) <ul style="list-style-type: none"> • For use with front-mounted auxiliary contact Connects 2-KTU7s Connects 3-KTU7s Connects 4-KTU7s Connects 5-KTU7s (shown) 	KTU7-D-3D ❶	KTU7-D-DB-45-2 KTU7-D-DB-45-3 KTU7-D-DB-45-4 KTU7-D-DB-45-5
	Supply Block and Terminal <ul style="list-style-type: none"> • For power connection to Compact Busbar — 600V, KTU7-D...120A maximum • Top feed — overlaps commoning link • Meets requirements for terminal spacing from source • Compliant with UL489 Terminal Clearance standards 	KTU7-D-3D ❶	KTU7-D-A3E
	Load Terminal Cover <ul style="list-style-type: none"> • For UL 489 compliance of front mounted auxiliary contacts when installed on KTU7 • The cover packaged in quantities of 10 (must order 10 for one package of 10) 	KTU7	KT7-PEFC

❶ For use with KTU7 3-pole Circuit Breakers only.

Application Rating Chart

KTU7	High Fault SCCR			Switching Lighting Rated		
	Combined with ❶	480Y/277 VAC (KA)	600Y/347 VAC (KA)	Fluorescent ❷	High-intensity Discharge ❸	HVAC Rated ❹
KTU7-D-2D-0.5	CA7-9...23	65	35	~	HID	HARC
KTU7-D-2D-1	CA7-9...23	65	35	~	HID	HARC
KTU7-D-2D-2	CA7-9...23	65	35	~	HID	HARC
KTU7-D-2D-3	CA7-9...23	65	35	~	HID	HARC
KTU7-D-2D-4	CA7-9...23	65	35	~	HID	HARC
KTU7-D-2D-5	CA7-9...23	65	35	~	HID	HARC
KTU7-D-2D-6	CA7-9...23	65	35	~	HID	HARC
KTU7-D-2D-8	CA7-9...23	65	35	~	HID	HARC
KTU7-D-2D-10	CA7-9...23	65	35	~	HID	HARC
KTU7-D-2D-12	CA7-9...23	65	35	~	HID	HARC
KTU7-D-2D-15	CA7-9...23	65	35	SWD	HID	HARC
KTU7-D-2D-20	CA7-9...23	65	35	SWD	HID	HARC
KTU7-D-2D-25	CA7-9...30	65	35	~	HID	HARC
KTU7-D-2D-30	CA7-9...30	65	35	~	~	HARC
KTU7-D-3D-0.5	CA7-9...23	65	35	~	HID	HARC
KTU7-D-3D-1	CA7-9...23	65	35	~	HID	HARC
KTU7-D-3D-2	CA7-9...23	65	35	~	HID	HARC
KTU7-D-3D-3	CA7-9...23	65	35	~	HID	HARC
KTU7-D-3D-4	CA7-9...23	65	35	~	HID	HARC
KTU7-D-3D-5	CA7-9...23	65	35	~	HID	HARC
KTU7-D-3D-6	CA7-9...23	65	35	~	HID	HARC
KTU7-D-3D-8	CA7-9...23	65	35	~	HID	HARC
KTU7-D-3D-10	CA7-9...23	65	35	~	HID	HARC
KTU7-D-3D-12	CA7-9...23	65	35	~	HID	HARC
KTU7-D-3D-15	CA7-9...23	65	35	~	HID	HARC
KTU7-D-3D-20	CA7-9...23	65	35	~	HID	HARC
KTU7-D-3D-25	CA7-9...30	65	35	~	HID	HARC
KTU7-D-3D-30	CA7-9...30	65	35	~	HID	HARC

IEC Performance Data

(CSA C22.2, UL 489, IEC / EN 60947-1, -2 in connection with a short-circuit protection device

		KTU7-D- 2 pole & 3 pole													
		0.5A	1A	2A	3A	4A	5A	6A	8A	10A	12A	15A	20A	25A	30A
Rated Operational Current I_n	[A]	0.5	1	2	3	4	5	6	8	10	12	15	20	25	30
Fixed Thermal Trip $I_t = I_n$	[A]	0.5	1	2	3	4	5	6	8	10	12	15	20	25	30
Fixed Magnetic Trip $I_m =$	[A]	15...20 x I_n													

Ultimate Short Circuit

Breaking Capacity (50 Hz) I_{cu}		0.5A	1A	2A	3A	4A	5A	6A	8A	10A	12A	15A	20A	25A	30A
230...240V	[kA]	100	100	100	100	100	100	100	100	100	100	100	100	100	100
400...415V	[kA]	100	100	100	100	100	100	100	100	100	65	65	65	65	65
525V	[kA]	65	65	65	65	65	65	65	65	65	65	65	65	65	65
690V	[kA]	50	50	18	18	18	18	18	10	10	10	10	10	10	10

Rated Service Short Circuit
Breaking Capacity (50 Hz) I_{cs}



		0.5A	1A	2A	3A	4A	5A	6A	8A	10A	12A	15A	20A	25A	30A
230...240V	[kA]	100	100	100	100	100	100	100	100	100	100	100	100	100	100
400...415V	[kA]	65	65	65	65	65	65	65	65	65	50	50	50	50	50
525V	[kA]	65	65	65	65	65	65	65	65	65	50	50	50	25	25
690V	[kA]	50	50	10	10	10	10	10	6	6	6	6	6	6	6



- ❶ KTU7 + CA7-9...23 contactor maybe combined with CEP7 overload. SCCR ratings remain unchanged.
- ❷ KTU7 circuit breaker intended to switch fluorescent lighting on a regular basis. Selection of sizes limited by UL489. Devices marked with "SWD".
- ❸ KTU7 Circuit Breakers intended to switch high-intensity discharge (ballast) lighting devices marked with "HID".
- ❹ Rated for use with heating, air conditioning, refrigeration. Devices marked with "HARC".

General Data

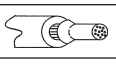
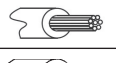
		KTU7-D
Number of Poles		2 and 3
Rated Insulation Voltage U_i		
IEC, / EN	[V]	600
UL, CSA	[V]	600
Ratings		HACR
Suitable for continuous operation at 100% of rating only if used in enclosure space for		0.5...15 A, enclosure space 250 x 175 x 150 mm (10 x 7 x 6 in)
Rated Impulse Withstand Voltage U_{imp}		
Pollution degree		3
Main circuits U _{imp} /Overvoltage Category		6 kV/III
Auxiliary circuits U _{imp} /Overvoltage Category		6 kV/III
Safe separation between main and auxiliary circuits		up to 400V
Rated Frequency	[Hz]	50/60
Utilization Category		
• IEC 60947-2 (Circuit Breaker)		A
Life Span		
Mechanical	[operations]	100,000
Electrical (I _e max.)	[operations]	10,000
Switching Frequency	[operations/h]	max. 25
Ambient Temperature		
Storage	[°C]	-40...+80
Operation	[°C]	-25...+60 (70 with 15% I _n current reduction)
Resistance to Climatic Change		
Moisture / Heat Resistance	(600068-2-30)	23 °C / 83 % relative humidity and 40 °C / 92 % relative humidity, 56 cycles
Dry Heat	(60086-2-2)	100 °C, relative humidity <50 %, 7 days
Moisture / Change Resistance	(60086-2-3)	40 °C, relative humidity 93 %, 56 days
Site Altitude	[m]	to 2000 N.N.
Protection Class		IP2X, when wired
Resistance to Shock	Transport (60068-2-27)	30 g, 11 ms, all axes
Resistance to Vibration	Operation (60068-2-6)	18 g
Overload Protection		
Phase-loss protection		No phase loss protection
Short circuit protection (Magnetic)		Fixed setting 10...20 x I _n
Main Disconnect Switch Application		Yes, with accessories
For utilization outside North America, Assemblies (of products) shall comply to the IEC61439-1 requirements		
Application Conditions	KTU7 circuit breakers are intended for use in closed areas without hazardous operating conditions such as dust or explosive or corrosive gases. Enclosures of appropriate manner need to be in place to protect devices in such environments.	
Standards	UL489; CSA C22.2 No. 5; IEC / EN 60947-1, -2	
Certifications	CE; cULus listed Circuit Breaker, File No. E334037 and E33916 (accessories)	

Terminal Specifications

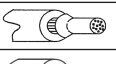
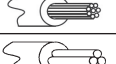
		KTU7-D	
Terminal Parts			
Terminal Type		Pozidrive No. 2 / Blade No. 3	
Screwdriver		Pozidrive No. 2 / Blade No. 3	
	1. conductor	[mm ²]/[AWG]	1...6/—
	2. conductor	[mm ²]/[AWG]	1...4/—
	1. conductor	[mm ²]/[AWG]	1...6/—
	2. conductor	[mm ²]/[AWG]	1...6/—
	1. conductor	[mm ²]/[AWG]	—/No. 18...10
	2. conductor	[mm ²]/[AWG]	—/No. 18...10
	1. conductor	[mm ²]/[AWG]	1...6/No. 18...10
	2. conductor	[mm ²]/[AWG]	1...6/No. 18...10
Tightening Torque		[N•m] [lb•in]	2...2.5/18...22
Weight		[g]	395

		KTU7-D-A3E	
Use 75 °C Cu wire only			
Rated Thermal Current I_{th}		[A]	64
	1. conductor	[mm ²]/[AWG]	2.5...25/14...4
	1. conductor	[mm ²]/[AWG]	2.5...25/14...4
	1. conductor	[mm ²]/[AWG]	2.5...25/14...4
	1. conductor	[mm ²]/[AWG]	2.5...25/14...4
Tightening Torque		[N•m] [lb•in]	3...3.5/27...31

Time-Current Characteristic

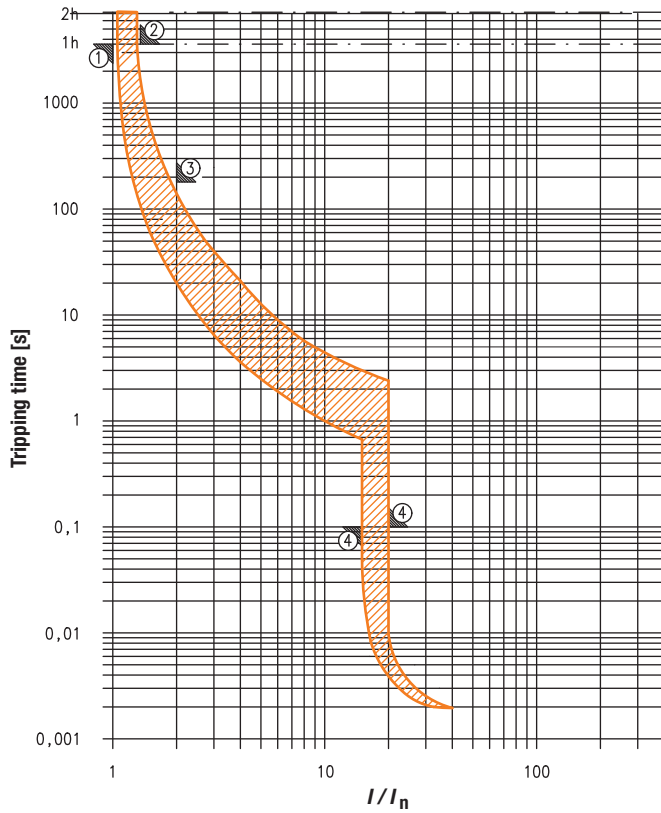

Tripping characteristic acc. to UL 489 and IEC 60947-2

- ① conventional non-tripping current $I_{nt} = 1.0 I_n$
- ② conventional tripping current $I_t = 1.35 I_n : t = < 1h$
- ③ $2.0 I_n : t = 180s \text{ max.}$

Instantaneous tripping acc. to UL 489 and IEC 60947-2

- ④ Trip Curve : $15 \dots 20 I_n$

Maximum Cut-off (Let-Through) Current

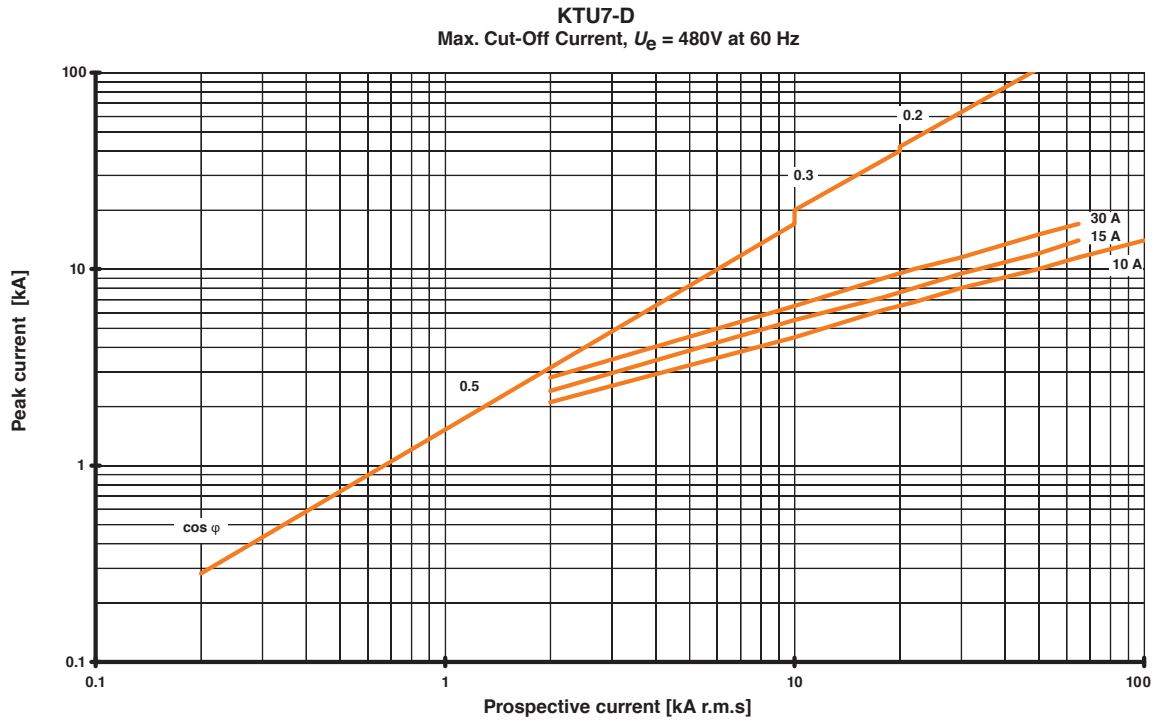

Maximum Let-Through Energy

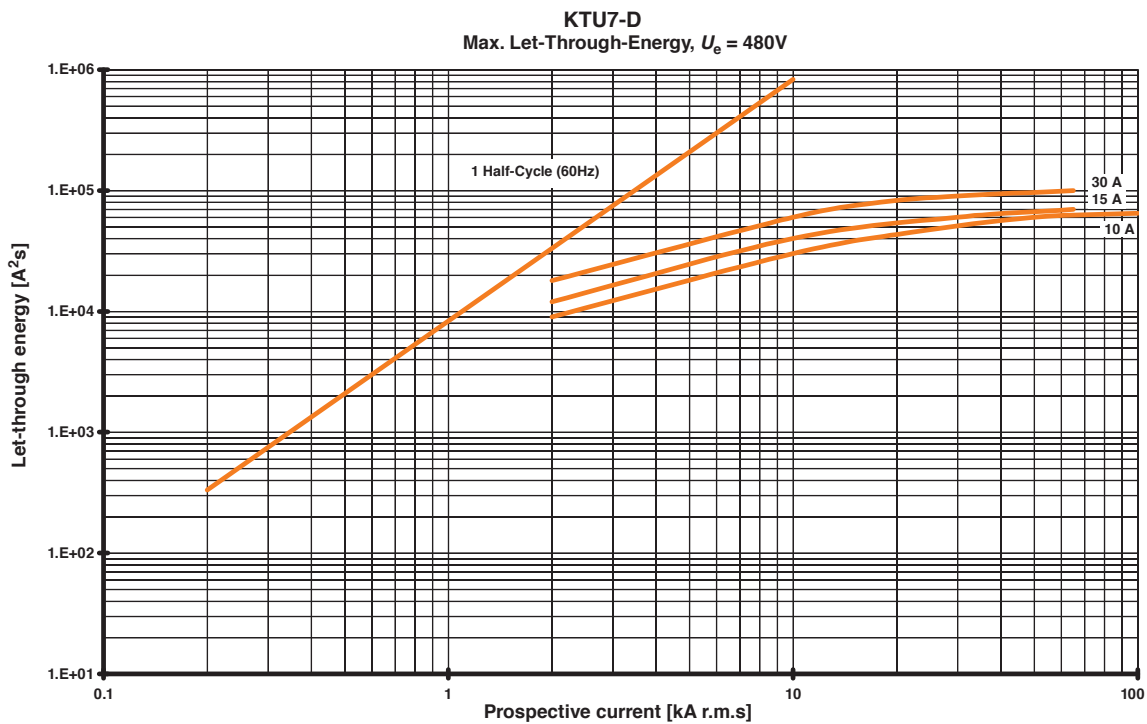

F

KTU7 Molded Case Circuit Breakers

KTU7-D Dimensions

Dimensions are in millimeters (inches). Dimensions not intended for manufacturing purposes.

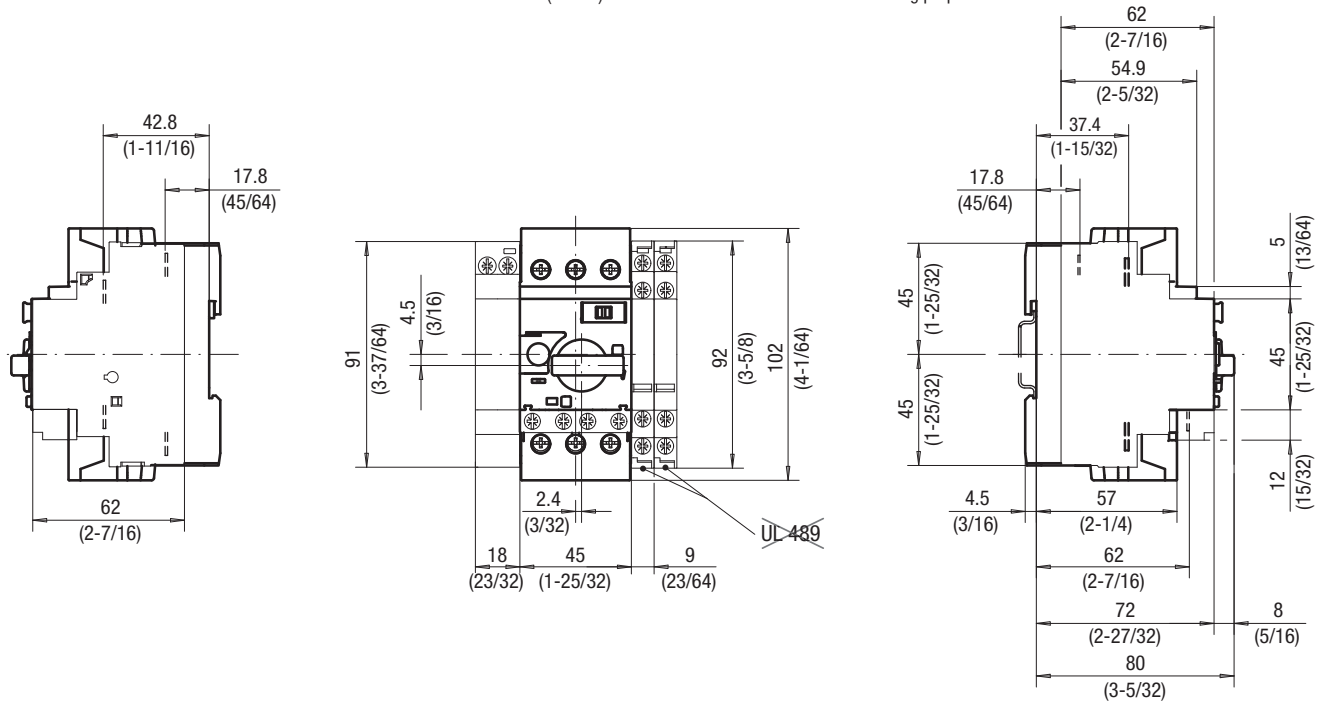

KTU7 Circuit Breaker Enclosure Requirements

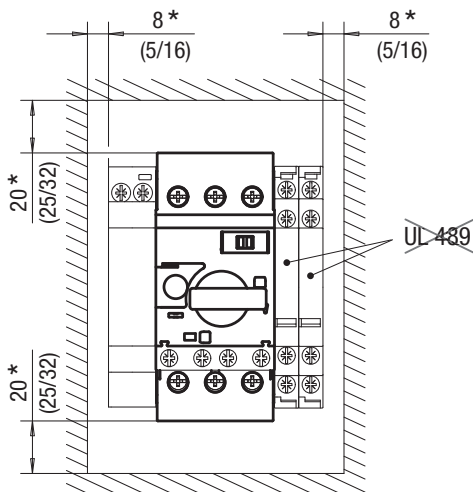

* - Minimum distance to grounded parts or walls

KTU7 Wiring Diagram

**3-Phase
KTU7-D-3**

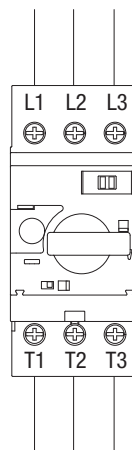

**2-Phase
KTU7-D-2**

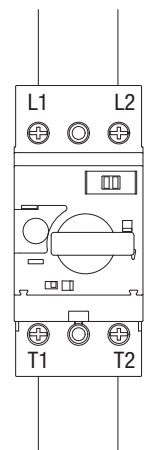

F
KTU7 Molded Case Circuit Breakers

KTU7 with Busbar

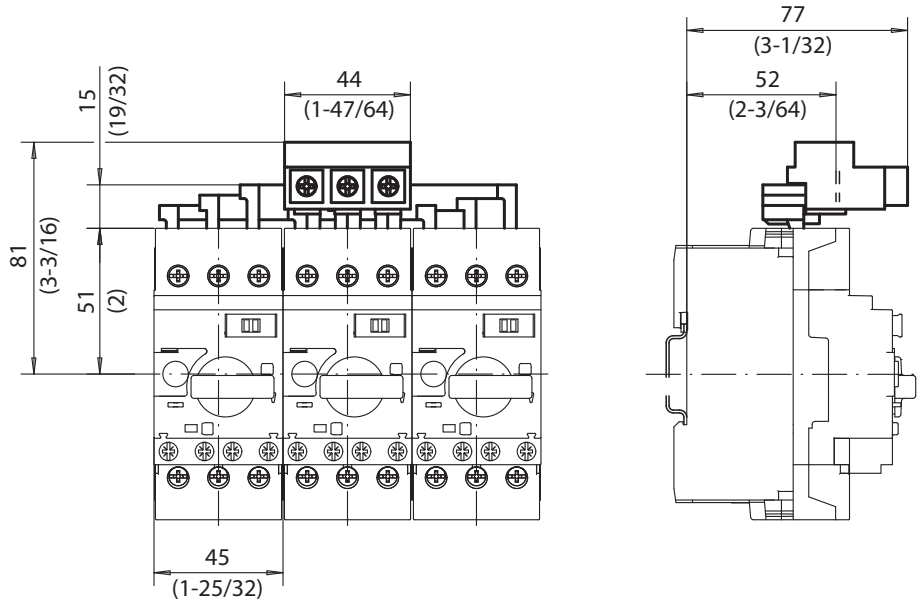

KTU7 with Screw Adaptor KT7-45-AS

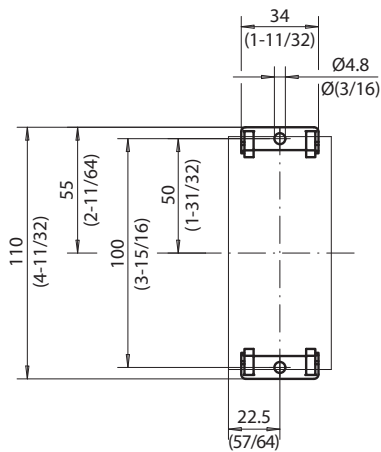

KTU7 Mounting Position

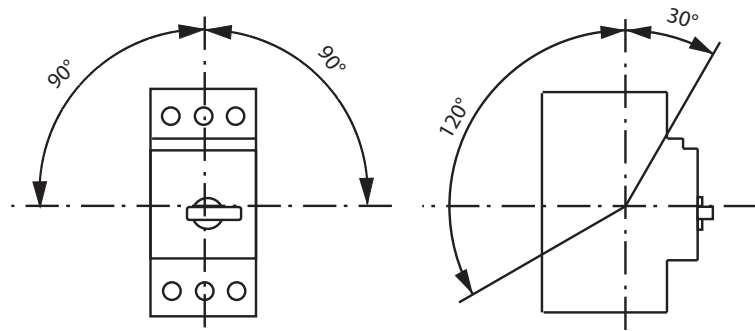

F

KTU7 Molded Case Circuit Breakers

Ecombo and EcomboPlus Starters

Save space, save money in individual or multi-motor starter applications

Sprecher + Schuh's Ecombo and EcomboPlus starters are the compact alternative to larger and higher priced combination starters. Both models consist of a KTA7 Motor Circuit Controller (cULus listed as a Type E, self-protected combination starter), assembled with a CA7 or CA8 contactor, which provides remote operation (Type E/F). Whether used as a standalone starter or in multi-motor starter applications, Ecombo and EcomboPlus starters save significant panel space and dollars over conventional combination starter alternatives.

Control and protection for most industrial applications

The Ecombo starter line covers motors to 45 amperes, while providing current limiting short circuit protection up to 65kA. Class 10 thermal overload protection is also assured with a very accurate current adjustment setting which is factory calibrated to the smallest and largest current the unit can handle. A "differential tripping" mechanism also provides acceleration tripping under single phase conditions (see illustration on page 14). Ecombo starters may be selected as Type 2 Coordinated per IEC 60947-4-1, or UL Construction Type E or F.



CL7 Ecombo starter

CK7 EcomboPlus starter

CLT7 Three-Component starter

F Ecombo Circuit Controllers

See our online white paper

Methods of Applying



Motor Circuit Controllers



Section Obsolete See pages F1.40 - F1.55

EcomboPlus... the complete solution

The EcomboPlus starter (CK7) is factory assembled on a special socket base that provides support and allows the starter to be mounted on one or two DIN-rails or screw mounted. Each starter comes standard with a front mounted auxiliary trip contact that is pre-wired to a built-in terminal block at the bottom of the unit. Contactor coil connections are also at the bottom of the starter to provide attractive and cost effective panel wiring.

Reduce panel size, complexity and cost

Because KT7 Motor Circuit Controllers are UL listed as self-protected combination starters, NEC / CEC group motor rules are simplified substantially. In many cases, only a non-fused switch is required for panel disconnect. See our online white paper "Methods of Applying KT7 Motor Circuit Controllers", which explains applying KT7s in multi-motor starter applications.

The Ecombo starter...

Ecombo starters (CL7) come standard with a KTA7 Motor Circuit Controller connected to Sprecher + Schuh's CA7 contactor (or CA8 mini contactor) through a specially designed connection module. The unit is DIN-rail mounted. Contactor coil connections are at the bottom of the starter to provide attractive and cost effective panel wiring. Ecombo starters may also be purchased with just three parts and assembled by the user to further increase economy. The CLT7 is a three component starter with a KTB7 controller, CA7 contactor, and a CEP7 solid state overload relay, pre-assembled on a bus bar module and ready to mount to a DIN rail or panel.

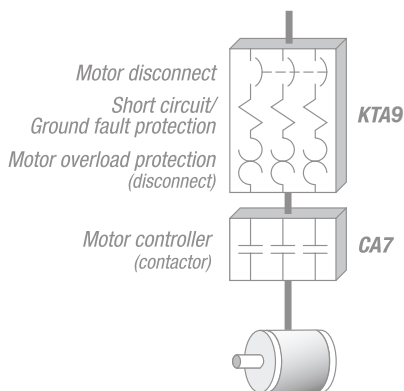

The Ecombo starter line combines a KTA7 self-protected Type E combination controller with a CA7 contactor to form a cost effective compact Type E/F alternative to traditional combination starters.

Starter Type	
EcomboPlus Starter with CA7	
CK7	2 component DOL Starter
CKU7	2 component REV Starter
Ecombo Starter with CA7	
CL7	2 component DOL Starter
CLU7	2 component REV Starter
CLT7	3 component DOL Starter
CLUT7	3 component REV Starter
Ecombo Starter with CA8	
CL8	2 component DOL Starter
CLU8	2 component REV Starter

Contactor Series	
Series CA7 	
	9(E)
	12(E)
	16(E)
	23(E)
	30(E)
	37(E)
	43(E)
Series CA8	
	9(C)
	12(C)

Auxiliary Contact	
01	1 NC
10	1 NO
11	1 NO + 1 NC
02	2 NC
22	2 NO + 2 NC

Control Voltage*	
Code	AC Voltage
24Z	24V 50/60Hz
120	110V 50Hz / 120V 60Hz
220W	200...220V 50Hz / 208...240V 60Hz
277	240V 50Hz / 277V 60Hz
480	440V 50Hz / 480V 60Hz
600	550V 50Hz / 600V 60Hz
Code	DC Voltage
12D(E)	12V
24D(E)	24V
48D(E)	48V
110D(E)	110V
220D(E)	220V

* Other control voltages available
(E) designates Electronic DC Coils

This illustration is for reference only.

Section Obsolete
See pages F1.40 - F1.55

Turn to the appropriate page to determine specific catalog number

Circuit Breaker Type	
KT..Z	
A...	Motor Protection
B...	Starter Protection
C...	High Inrush Protection
...S	Standard Performance
...H	High Performance

Adj. Range	
0.16A	0.1...0.16A
0.25A	0.16...0.25A
0.4A	0.25...0.4A
0.63A	0.4...0.63A
1A	0.63...1.0A
1.6A	1.0...1.6A
2.5A	1.6...2.5A
4A	2.5...4.0A
6.3A	4.0...6.3A
10A	6.3...10A
16A	10...16A
20A	16...20A
25A	20...25A
32A	25...32A
45A	32...45A

Auxiliaries + Trip Contacts	
X	No auxiliary contacts
Front Mounted Auxiliaries	
A10	Aux. Contact 1 NO
A01	Aux. Contact 1 NC
A11	Aux. Contact 1 NO + 1 NC
A20	Aux. Contact 2 NO
T10A01	1 NO Short Circuit or Overload + 1 NC Aux. Contact
T10A10	1 NO Short Circuit or Overload + 1 NO Aux. Contact
Side Mounted Auxiliaries	
AS11	Aux. Contact 1 NO + 1 NC
AS20	Aux. Contact 2 NO
R10	1 NC Short Circuit or Overload + 1 NO Aux. Contact
R11	1 NC Short Circuit or Overload + 1 NC Aux. Contact

Option(s)
For complete listing of **Option Codes**, refer to Modifications page in this section.

 (D & E) designations indicate DC coil.

Non-Reversing Ecombo Starters with AC Coil, Series CA8 Contactor

Thermal Trip [A]	Magnetic Trip [A]	Index ①	Typical Three Phase [HP]				Catalog Number ②
			200V	230V	460V	575V	
KTA7-25S — Standard Interrupting Capacity							
0.10...0.16	2.1	1M	~	~	~	~	CL8-09-10-*AS0.16A-X
0.16...0.25	3.3	2M	~	~	~	~	CL8-09-10-*AS0.25A-X
0.25...0.40	5.2	3M	~	~	~	~	CL8-09-10-*AS0.4A-X
0.40...0.63	8.2	4M	~	~	~	~	CL8-09-10-*AS0.63A-X
0.63...1	13	5M	~	~	~	1/2	CL8-09-10-*AS1A-X
1...1.6	21	6M	~	~	1/2	3/4	CL8-09-10-*AS1.6A-X
1.6...2.5	33	7M	1/2	1/2	1	1-1/2	CL8-09-10-*AS2.5A-X
2.5...4	52	8M	3/4	3/4	2	3	CL8-09-10-*AS4A-X
4...6.3	82	9M	1	1-1/2	3	~	CL8-09-10-*AS6.3A-X
6.3...10	130	10M	2	2	5	~	CL8-09-10-*AS10A-X
6.3...10	130	11M	~	3	~	~	CL8-12-10-*AS10A-X
10...16	208	12M	3	~	7-1/2	~	CL8-12-10-*AS16A-X



Includes:

- KTA7-25S (Standard Interrupting Capacity) Motor Controller
- CA8 Contactor
- Connecting Module (Cat.# KT7-25S-PEK12)
- Terminal Adaptor for Type F Applications (Cat.# KT7-25-TE1)
- Can mount on one DIN-rail

Non-Reversing Ecombo Starters with DC Coil, Series CA8 Contactor

Thermal Trip [A]	Magnetic Trip [A]	Index ①	Typical Three Phase [HP]				Catalog Number ②
			200V	230V	460V	575V	
KTA7-25S — Standard Interrupting Capacity							
0.10...0.16	2.1	1M	~	~	~	~	CL8-09C-10-*AS0.16A-X
0.16...0.25	3.3	2M	~	~	~	~	CL8-09C-10-*AS0.25A-X
0.25...0.40	5.2	3M	~	~	~	~	CL8-09C-10-*AS0.4A-X
0.40...0.63	8.2	4M	~	~	~	~	CL8-09C-10-*AS0.63A-X
0.63...1	13	5M	~	~	~	1/2	CL8-09C-10-*AS1A-X
1...1.6	21	6M	~	~	1/2	3/4	CL8-09C-10-*AS1.6A-X
1.6...2.5	33	7M	1/2	1/2	1	1-1/2	CL8-09C-10-*AS2.5A-X
2.5...4	52	8M	3/4	3/4	2	3	CL8-09C-10-*AS4A-X
4...6.3	82	9M	1	1-1/2	3	~	CL8-09C-10-*AS6.3A-X
6.3...10	130	10M	2	2	5	~	CL8-09C-10-*AS10A-X
6.3...10	130	11M	~	3	~	~	CL8-12C-10-*AS10A-X
10...16	208	12M	3	~	7-1/2	~	CL8-12C-10-*AS16A-X

Section Obsolete
See pages F1.40 - F1.55

F Ecombo Circuit Controllers

AC Coil Codes ③

AC Coil Code	Voltage Range	
	50 Hz	60 Hz
12	12V	12V
24Z	24V	24V
48Z	48V	48V
120	110V	120V
208	200V-220V	200V-220V
240	240V	240V
380 ⑥	Use Coil Code 400	
400 ⑥	400V	400V
480	440V	480V
575 ⑥	Use Coil Code 600	
600 ⑥	525V	600V

DC Coil Codes ③

DC Coil Code	Voltage
12D	12V
24D	24V ④
110D	110V
125D	125V
220D	220V

Horsepower ratings shown in the tables are for reference only. The final selection of the controller depends on the actual motor full load current and service factor.

- For motor with service factor less than 1.15. Use motor nameplate full load current times 0.9 and choose the motor starter with the appropriate current range. Example: Motor F.L.C. = 4.2A; S.F. = 1.0. - 4.2A x 0.9 = 3.78A. Select Catalog Number KTA7-25S-4A.

Ordering Instructions

Specify Catalog Number	
Replace (*) with Coil Code	See Coil Code table on this page for codes.

- ① KAIC Assembly Rating Index. See pages F73-F76 for Application Rating Guide.
- ② Does not include auxiliary contacts. See Factory Options on page F69 for additional auxiliary contact configurations.
- ③ The coil codes shown are the most commonly stocked items. Contact your Sprecher + Schuh representative if special voltages are required.
- ④ Integrated surge suppressor for coil is available. See page F69 for options.
- ⑤ The European Community has agreed that 400V is the nominal voltage in lieu of 380V. Use this code when 380V is required.
- ⑥ Use this code for 575V applications.

Reversing Ecombo Starters with AC Coil, Series CA8 Contactor

Thermal Trip [A]	Magnetic Trip [A]	Index ❶	Typical Three Phase [HP]				Catalog Number ❷
			200V	230V	460V	575V	
KTA7-25S — Standard Interrupting Capacity							
0.10...0.16	2.1	1M	~	~	~	~	CLU8-09-02- * -AS0.16A-X
0.16...0.25	3.3	2M	~	~	~	~	CLU8-09-02- * -AS0.25A-X
0.25...0.40	5.2	3M	~	~	~	~	CLU8-09-02- * -AS0.4A-X
0.40...0.63	8.2	4M	~	~	~	~	CLU8-09-02- * -AS0.63A-X
0.63...1	13	5M	~	~	~	1/2	CLU8-09-02- * -AS1A-X
1...1.6	21	6M	~	~	1/2	3/4	CLU8-09-02- * -AS1.6A-X
1.6...2.5	33	7M	1/2	1/2	1	1-1/2	CLU8-09-02- * -AS2.5A-X
2.5...4	52	8M	3/4	3/4	2	3	CLU8-09-02- * -AS4A-X
4...6.3	82	9M	1	1-1/2	3	~	CLU8-09-02- * -AS6.3A-X
6.3...10	130	10M	2	2	5	~	CLU8-09-02- * -AS10A-X
6.3...10	130	11M	~	3	~	~	CLU8-12-02- * -AS10A-X
10...16	208	12M	3	~	7-1/2	~	CLU8-12-02- * -AS16A-X

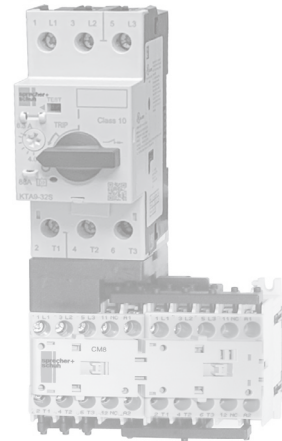

Includes:

- KTA7-25S (Standard Interrupting Capacity) Motor Controller
- One Reversing CAU8 Contactor with Mechanical Interlock (CM8) Connecting Module (Cat.# KT7-25S-PEK12)
- Terminal Adaptor for Type F Applications (Cat.# KT7-25-TE1)
- Reversing Power Wiring Kit (Cat.# CAUT8-PW)
- Can mount on one DIN-rail

Reversing Ecombo Starters with DC Coil, Series CA8 Contactor

Thermal Trip [A]	Magnetic Trip [A]	Index ❶	Typical Three Phase [HP]				Catalog Number ❷
			200V	230V	460V	575V	
KTA7-25S — Standard Interrupting Capacity							
0.10...0.16	2.1	1M	~	~	~	~	CLU8-09C-02- * -AS0.16A-X
0.16...0.25	3.3	2M	~	~	~	~	CLU8-09C-02- * -AS0.25A-X
0.25...0.40	5.2	3M	~	~	~	~	CLU8-09C-02- * -AS0.4A-X
0.40...0.63	8.2	4M	~	~	~	~	CLU8-09C-02- * -AS0.63A-X
0.63...1	13	5M	~	~	~	1/2	CLU8-09C-02- * -AS1A-X
1...1.6	21	6M	~	~	1/2	3/4	CLU8-09C-02- * -AS1.6A-X
1.6...2.5	33	7M	1/2	1/2	1	1-1/2	CLU8-09C-02- * -AS2.5A-X
2.5...4	52	8M	3/4	3/4	2	3	CLU8-09C-02- * -AS4A-X
4...6.3	82	9M	1	1-1/2	3	~	CLU8-09C-02- * -AS6.3A-X
6.3...10	130	10M	2	2	5	~	CLU8-09C-02- * -AS10A-X
6.3...10	130	11M	~	3	~	~	CLU8-12C-02- * -AS10A-X
10...16	208	12M	3	~	7-1/2	~	CLU8-12C-02- * -AS16A-X

Section Obsolete
See pages F1.40 - F1.55

AC Coil Codes ❸

AC Coil Code	Voltage Range	
	50 Hz	60 Hz
12	12V	12V
24Z	24V	24V
48Z	48V	48V
120	110V	120V
208	200V-220V	200V-220V
240	240V	240V
380 ❹	Use Coil Code 400	
400 ❹	400V	400V
480	440V	480V
575 ❺	Use Coil Code 600	
600 ❺	525V	600V

DC Coil Codes ❸

DC Coil Code	Voltage
12D	12V
24D	24V ❹
110D	110V
125D	125V
220D	220V

Horsepower ratings shown in the tables are for reference only. The final selection of the controller depends on the actual motor full load current and service factor.

- For motor with service factor less than 1.15. Use motor nameplate full load current times 0.9 and choose the motor starter with the appropriate current range. Example: Motor F.L.C. = 4.2A; S.F. = 1.0. - 4.2A x 0.9 = 3.78A. Select Catalog Number KTA7-25S-4A.

Ordering Instructions

Specify Catalog Number	
Replace (*) with Coil Code	See Coil Code table on this page for codes.

- ❶ KAIC Assembly Rating Index. See pages F73-F76 for Application Rating Guide.
- ❷ Does not include auxiliary contacts. See Factory Options on page F69 for additional auxiliary contact configurations.
- ❸ The coil codes shown are the most commonly stocked items. Contact your Sprecher + Schuh representative if special voltages are required.
- ❹ Integrated surge suppressor for coil is available. See page F69 for options.
- ❺ The European Community has agreed that 400V is the nominal voltage in lieu of 380V. Use this code when 380V is required.
- ❻ Use this code for 575V applications.

F Ecombo Circuit Controllers

Non-Reversing Ecombo Starters with AC Coil, Series CA7 Contactor ③

Thermal Trip [A]	Magnetic Trip [A]	Index ①	Typical Three Phase [HP]				Catalog Number ②⑥
			200V	230V	460V	575V	
KTA7-25S — Standard Interrupting Capacity							
0.10...0.16	2.1	1	~	~	~	~	CL7-9-10-*-AS0.16A-A10
0.16...0.25	3.3	2	~	~	~	~	CL7-9-10-*-AS0.25A-A10
0.25...0.40	5.2	3	~	~	~	~	CL7-9-10-*-AS0.4A-A10
0.40...0.63	8.2	4	~	~	~	~	CL7-9-10-*-AS0.63A-A10
0.63...1	13	5	~	~	~	1/2	CL7-9-10-*-AS1A-A10
1...1.6	21	6	~	~	1/2	3/4	CL7-9-10-*-AS1.6A-A10
1.6...2.5	33	7	1/2	1/2	1	1-1/2	CL7-9-10-*-AS2.5A-A10
2.5...4	52	8	3/4	3/4	2	3	CL7-9-10-*-AS4A-A10
4...6.3	82	9	1	1-1/2	3	5	CL7-9-10-*-AS6.3A-A10 ⑤
6.3...10	130	11	2	3	5	7-1/2 ⑤	CL7-12-10-*-AS10A-A10 ⑤
10...16	208	12	3	5	10	10 ⑤	CL7-16-10-*-AS16A-A10 ⑤
14.5...20	260	15	5	5	10	15 ⑤	CL7-23-10-*-AS20A-A10 ⑤
18.5...25	325	16	5 ⑤	7-1/2 ⑤	15 ⑤	20 ⑤	CL7-23-10-*-AS25A-A10 ⑤
KTA7-25H — High Interrupting Capacity							
1.6...2.5	33	17	1/2	1/2	1	1-1/2	CL7-9-10-*-AH2.5A-A10
2.5...4	52	19	3/4	3/4	2	3	CL7-9-10-*-AH4A-A10
4...6.3	82	22	1	1-1/2	3	5	CL7-9-10-*-AH6.3A-A10
6.3...10	130	24	2	3	5	7-1/2	CL7-12-10-*-AH10A-A10
10...16	208	28	3	5	10	10	CL7-16-10-*-AH16A-A10
14.5...20	260	31	5	5	10	15 ⑤	CL7-23-10-*-AH20A-A10 ⑤
18...25	325	33	5	7-1/2	15	20 ⑤	CL7-23-10-*-AH25A-A10 ⑤
KTA7-45H — High Interrupting Capacity ④							
6.3...10	130	36	2	3	5	7-1/2	CL7-30-10-*-AH10A-A10-W
10...16	208	37	3	5	10	10	CL7-30-10-*-AH16A-A10-W
14.5...20	260	38	5	5	15	15	CL7-30-10-*-AH20A-A10-W
18...25	325	39	7-1/2	10	15	20	CL7-30-10-*-AH25A-A10-W
23...32	416	41	7-1/2	10	20	25	CL7-30-10-*-AH32A-A10-W
32...45	585	45	10	10	25	30	CL7-37-10-*-AH45A-A10-W
32...45	585	46	10	15	25	30	CL7-43-11-*-AH45A-A10-W ④



CL7-16-10-AS16A-A10

Includes:

- KT7 Motor Controller with 1 NO Auxiliary Contact
- CA7 Contactor (AC)
- Connecting Module (Cat.# KT7-25[S or H]-PEC23)
- Terminal Adaptor for Type E/F Applications
- Can mount on one DIN-rail

Optional: ③

- Type W Mounting Module is optional on 25S & 25H. Type W Module is standard on 45H models. See modifications on page F69.



For applications above 45 amps please consider a type combination starters on page C59.

Coil Codes (*) ②

AC Coil Code	Voltage Range	
	50 Hz	60 Hz
24Z	24V	24V
120	110V	120V
220W	200-220V	208-240V
277	240V	277V
415	400-415V	~
480 ⑥	440V	480V
600 ⑥	550V	600V

Horsepower ratings shown in the tables are for reference only. The final selection of the controller depends on the actual motor full load current and service factor.

- For motor with service factor less than 1.15. Use motor nameplate full load current times 0.9 and choose the motor starter with the appropriate current range. Example: Motor F.L.C. = 4.2A; S.F. = 1.0. - 4.2A x 0.9 = 3.78A. Select Catalog Number KTA7-25S-4A.

Ordering Instructions

Specify Catalog Number	
Replace (*) with Coil Code	See Coil Code table on this page for codes.

- ① KAIC Assembly Rating Index. See pages F73-F76 for Application Rating Guide.
- ② Other voltages available, see Section A in this catalog.
- ③ CL7-30...43 with KTA7-45H include Type W Mounting Modules for 35mm or 70mm DIN rail or Panel Mounting as necessary from page F17. To add Type W Mounting Modules for 25S or 25H models add -W to end of catalog number. See page F69 for modifications.
- ④ CL7-43 supplied with (1) NO and (1) NC front mount auxiliary.
- ⑤ Catalog numbers and/or specific voltages (i.e. @ 575V) shaded in gray are suitable for Group Installation, per NEC 430-53C, because they are not Type E/F rated. See page F73 for ratings.
- ⑥ Suffix -A10 uses front-mount KT7-PE1-10 300 VAC maximum control circuit. For control circuits greater than 300 VAC use side-mount KT7-PA1-11 and change suffix -A10 to -AS11 (example CL7-9-10-*-AS0.16A-AS11) See options on page F69.

Ecombo Circuit Controllers

Section Obsolete
See pages F1.40 - F1.55

Non-Reversing Ecombo Starters with Electronic DC Coil, Series CA7 Contactor ③

Thermal Trip [A]	Magnetic Trip [A]	Index ①	Typical Three Phase [HP]				Catalog Number ②
			200V	230V	460V	575V	
KTA7-25S — Standard Interrupting Capacity							
0.10...0.16	2.1	1	~	~	~	~	CL7-9E-10- <i>*</i> -AS0.16A-A10
0.16...0.25	3.3	2	~	~	~	~	CL7-9E-10- <i>*</i> -AS0.25A-A10
0.25...0.40	5.2	3	~	~	~	~	CL7-9E-10- <i>*</i> -AS0.4A-A10
0.40...0.63	8.2	4	~	~	~	~	CL7-9E-10- <i>*</i> -AS0.63A-A10
0.63...1	13	5	~	~	~	1/2	CL7-9E-10- <i>*</i> -AS1A-A10
1...1.6	21	6	~	~	1/2	3/4	CL7-9E-10- <i>*</i> -AS1.6A-A10
1.6...2.5	33	7	1/2	1/2	1	1-1/2	CL7-9E-10- <i>*</i> -AS2.5A-A10
2.5...4	52	8	3/4	3/4	2	3	CL7-9E-10- <i>*</i> -AS4A-A10
4...6.3	82	9	1	1-1/2	3	5 ⑥	CL7-9E-10- <i>*</i> -AS6.3A-A10 ③
6.3...10	130	11	2	3	5	7-1/2 ⑥	CL7-12E-10- <i>*</i> -AS10A-A10 ③
10...16	208	12	3	5	10	10 ⑥	CL7-16E-10- <i>*</i> -AS16A-A10 ③
14.5...20	260	15	5	5	10	15 ⑥	CL7-23E-10- <i>*</i> -AS20A-A10 ③
18.5...25	325	16	5 ⑥	7-1/2 ⑥	15 ⑥	20 ⑥	CL7-23E-10- <i>*</i> -AS25A-A10 ③
KTA7-25H — High Interrupting Capacity							
1.6...2.5	33	17	1/2	1/2	1	1-1/2	CL7-9E-10- <i>*</i> -AH2.5A-A10
2.5...4	52	19	3/4	3/4	2	3	CL7-9E-10- <i>*</i> -AH4A-A10
4...6.3	82	22	1	1-1/2	3	5	CL7-9E-10- <i>*</i> -AH6A-A10
6.3...10	130	24	2	3	5	7-1/2	CL7-12E-10- <i>*</i> -AH10A-A10
10...16	208	28	3	5	10	10	CL7-16E-10- <i>*</i> -AH16A-A10
14.5...20	260	31	5	5	10	15 ⑥	CL7-23E-10- <i>*</i> -AH20A-A10
18...25	325	33	5	7-1/2	15	20 ⑥	CL7-23E-10- <i>*</i> -AH25A-A10 ③
KTA7-45H — High Interrupting Capacity ④							
6.3...10	130	36	3	3	5	7-1/2	CL7-30E-10- <i>*</i> -AH10A-A10-W
10...16	208	38	3	5	10	10	CL7-30E-10- <i>*</i> -AH16A-A10-W
14.5...20	260	38	5	5	10	15	CL7-30E-10- <i>*</i> -AH20A-A10-W
18...25	325	39	7-1/2	7-1/2	15	20	CL7-30E-10- <i>*</i> -AH25A-A10-W
23...32	416	41	7-1/2	10	20	25	CL7-30E-10- <i>*</i> -AH32A-A10-W
32...45	585	44	10	10	25	30	CL7-37E-10- <i>*</i> -AH45A-A10-W
32...45	585	46	10	15	30	30	CL7-43E-11- <i>*</i> -AH45A-A10-W ⑤



CL7-23E-10-24E-AS25A-A10

Includes:

- KT7 Motor Controller with 1 NO Auxiliary Contact
- CA7-9E...43E Contactor
- Connecting Module (Cat.# KT7-25[S or H]-PEC23)
- Terminal Adaptor for Type E/F Applications
- Can mount on one DIN-rail

Optional: ③

- Type W Mounting Module is optional on 25S & 25H. Type W Module is standard on 45H models. See modifications on page F69.

Section Obsolete
See pages F1.40 - F1.55

For applications above 45 amps please consider open type combination starters on page C59

Coil Codes ②

DC Coil Codes	Voltage
12E	12V
24E	24V
36E	36-48V
48E	48-72V
110E	110-125V
220E	220-250V

Horsepower ratings shown in the tables are for reference only. The final selection of the controller depends on the actual motor full load current and service factor.

- For motor with service factor less than 1.15. Use motor nameplate full load current times 0.9 and choose the motor starter with the appropriate current range. Example: Motor F.L.C. = 4.2A; S.F. = 1.0. - 4.2A x 0.9 = 3.78A. Select Catalog Number KTA7-25S-4A.

Ordering Instructions

Specify Catalog Number	
Replace (*) with Coil Code	See Coil Code table on this page for codes.

- ① KAIC Assembly Rating Index. See pages F73-F76 for Application Rating Guide.
- ② CL7-9E...43E with electronic coils are not interchangeable with non-electronic DC or AC coils.
- ③ See Section A for limitations on adding auxiliaries to Electronic DC Coil contacts.
- ④ CL7-30E...43E with KTA7-45H include Type W Mounting Modules for 35mm or 70mm DIN rail or Panel Mounting as necessary from page F17. To add Type W Mounting Modules for 25S or 25H models add -W to end of catalog number. See page F69 for modifications.
- ⑤ CL7-43E supplied with (1) NO and (1) NC front mount auxiliary.
- ⑥ Catalog numbers and/or specific voltages (i.e. @ 575V) shaded in gray are suitable for Group Installation, per NEC 430-53C, because they are not Type E/F rated. See page F73 for ratings.

Reversing Ecombo Starters with AC Coil, Series CA7 Contactor ③

Thermal Trip [A]	Magnetic Trip [A]	Index ①	Typical Three Phase [HP]				Catalog Number ②⑥
			200V	230V	460V	575V	
KTA7-25S — Standard Interrupting Capacity							
0.10...0.16	2.1	1	~	~	~	~	CLU7-9-22-*AS0.16A-A10
0.16...0.25	3.3	2	~	~	~	~	CLU7-9-22-*AS0.25A-A10
0.25...0.40	5.2	3	~	~	~	~	CLU7-9-22-*AS0.4A-A10
0.40...0.63	8.2	4	~	~	~	~	CLU7-9-22-*AS0.63A-A10
0.63...1	13	5	~	~	~	1/2	CLU7-9-22-*AS1A-A10
1...1.6	21	6	~	~	1/2	3/4	CLU7-9-22-*AS1.6A-A10
1.6...2.5	33	7	1/2	1/2	1	1-1/2	CLU7-9-22-*AS2.5A-A10
2.5...4	52	8	3/4	3/4	2	3	CLU7-9-22-*AS4A-A10
4...6.3	82	9	1	1-1/2	3	5 ⑥	CLU7-9-22-*AS6.3A-A10 ⑥
6.3...10	130	11	2	3	5	7-1/2 ⑥	CLU7-12-22-*AS10A-A10 ⑥
10...16	208	12	3	5	10	10 ⑥	CLU7-16-22-*AS16A-A10 ⑥
14.5...20	260	15	5	5	10	15 ⑥	CLU7-23-22-*AS20A-A10 ⑥
18.5...25	325	16	5 ⑥	7-1/2 ⑥	15 ⑥	20 ⑥	CLU7-23-22-*AS25A-A10 ⑥
KTA7-25H — High Interrupting Capacity							
1.6...2.5	33	17	1/2	1/2	1	1-1/2	CLU7-9-22-*AH2.5A-A10
2.5...4	52	19	3/4	3/4	2	3	CLU7-9-22-*AH4A-A10
4...6.3	82	22	1	1-1/2	3	5	CLU7-9-22-*AH6.3A-A10
6.3...10	130	24	2	3	5	7-1/2	CLU7-12-22-*AH10A-A10
10...16	208	28	3	5	10	10	CLU7-16-22-*AH16A-A10
14.5...20	260	31	5	5	10	15 ⑥	CLU7-23-22-*AH20A-A10 ⑥
18...25	325	33	5	7-1/2	15	20 ⑥	CLU7-23-22-*AH25A-A10 ⑥
KTA7-45H — High Interrupting Capacity							
6.3...10	130	36	2	3	5	7-1/2	CLU7-30-22-*AH10A-A10-W
10...16	208	37	3	5	10	10	CLU7-30-22-*AH16A-A10-W
14.5...20	260	38	5	5	10	15	CLU7-30-22-*AH20A-A10-W
18...25	325	39	7-1/2	10	15	20	CLU7-30-22-*AH25A-A10-W
23...32	416	41	7-1/2	10	20	25	CLU7-30-22-*AH32A-A10-W
32...45	585	45	10	10	25	30	CLU7-37-22-*AH45A-A10-W
32...45	585	46	10	15	30	30	CLU7-43-22-*AH45A-A10-W ④

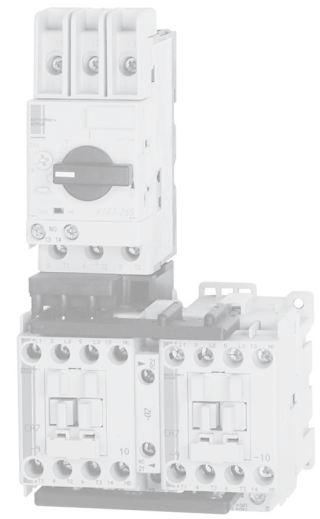

CLU7-9-22-120-AS25A-A10

Includes:

- KT7 Motor Controller with 1 NO Auxiliary Contact
- Two CA7 Contactors (AC)
- Connecting Module (Cat.# K17-25[S or H]-PEC23)
- Terminal Adaptor for Type E/F Applications
- Reversing Power Wiring Kit (Cat.# CAUT7-PW23)
- Electrical / Mechanical Interlock
- Can mount on one DIN-rail

Optional: ③

- Type W Mounting Module is optional on 25S & 25H. Type W Module is standard on 45H models. See modifications on page F69.

Section Obsolete
See pages F1.40 - F1.55

Coil Codes (*) ②

AC Coil Code	Voltage Range	
	50 Hz	60 Hz
24Z	24V	24V
120	110V	120V
220W	200-220V	208-240V
277	240V	277V
415	400-415V	~
480 ⑥	440V	480V
600 ⑥	550V	600V

Horsepower ratings shown in the tables are for reference only. The final selection of the controller depends on the actual motor full load current and service factor.

- For motor with service factor less than 1.15. Use motor nameplate full load current times 0.9 and choose the motor starter with the appropriate current range. Example: Motor F.L.C. = 4.2A; S.F. = 1.0. - 4.2A x 0.9 = 3.78A. Select Catalog Number KTA7-25S-4A.

Ordering Instructions

Specify Catalog Number	
Replace (*) with Coil Code	See Coil Code table on this page for codes.

- ① KAIC Assembly Rating Index. See pages F73-F76 for Application Rating Guide.
- ② Other voltages available, see Section A in this catalog.
- ③ CLU7-30...43 with KTA7-45H include Type W Mounting Modules for 35mm or 70mm DIN rail or Panel Mounting as necessary from page F17 To add Type W Mounting Modules for 25S or 25H models add -W to end of catalog number. See page F69 for modifications.
- ④ CLU7-43 supplied with (1) NO and (1) NC front mount auxiliary per contactor.
- ⑤ Catalog numbers and/or specific voltages (i.e. @ 575V) shaded in gray are suitable for Group Installation, per NEC 430-53C, because they are not Type E/F rated. See page F73 for ratings.
- ⑥ Suffix -A10 uses front-mount KT7-PE1-10 300 VAC maximum control circuit. For control circuits greater than 300 VAC use side-mount KT7-PA1-11 and change suffix -A10 to -AS11 (example CLU7-9-22-*AS0.16A-AS11) See options on page F69.

Reversing Ecombo Starters with Electronic DC Coil, Series CA7 Contactor ③

Thermal Trip [A]	Magnetic Trip [A]	Index ①	Typical Three Phase [HP]				Catalog Number ②
			200V	230V	460V	575V	
KTA7-25S — Standard Interrupting Capacity							
0.10...0.16	2.1	1	~	~	~	~	CLU7-9E-22-*AS0.16A-A10
0.16...0.25	3.3	2	~	~	~	~	CLU7-9E-22-*AS0.25A-A10
0.25...0.40	5.2	3	~	~	~	~	CLU7-9E-22-*AS0.4A-A10
0.40...0.63	8.2	4	~	~	~	~	CLU7-9E-22-*AS0.63A-A10
0.63...1	13	5	~	~	~	1/2	CLU7-9E-22-*AS1A-A10
1...1.6	21	6	~	~	1/2	3/4	CLU7-9E-22-*AS1.6A-A10
1.6...2.5	33	7	1/2	1/2	1	1-1/2	CLU7-9E-22-*AS2.5A-A10
2.5...4	52	8	3/4	3/4	2	3	CLU7-9E-22-*AS4A-A10
4...6.3	82	9	1	1-1/2	3	5 ⑥	CLU7-9E-22-*AS6.3A-A10 ⑥
6.3...10	130	11	2	3	5	7-1/2 ⑥	CLU7-12E-22-*AS10A-A10 ⑥
10...16	208	12	3	5	10	10 ⑥	CLU7-16E-22-*AS16A-A10 ⑥
14.5...20	260	15	5	5	10	15 ⑥	CLU7-23E-22-*AS20A-A10 ⑥
18.5...25	325	16	5 ⑥	7-1/2 ⑥	15 ⑥	20 ⑥	CLU7-23E-22-*AS25A-A10 ⑥
KTA7-25H — High Interrupting Capacity							
1.6...2.5	33	17	1/2	1/2	1	1-1/2	CLU7-9E-22-*AH2.5A-A10
2.5...4	52	19	3/4	3/4	2	3	CLU7-9E-22-*AH4A-A10
4...6.3	82	22	1	1-1/2	3	5	CLU7-9E-22-*AH3A-A10
6.3...10	130	24	2	3	5	7-1/2	CLU7-12E-22-*AH4A-A10
10...16	208	28	3	5	10	10	CLU7-16E-22-*AH16A-A10
14.5...20	260	31	5	5	10	15	CLU7-23E-22-*AH20A-A10 ⑥
18...25	325	33	5	7-1/2	15	20 ⑥	CLU7-23E-22-*AH25A-A10 ⑥
KTA7-45H — High Interrupting Capacity ④							
6.3...10	130	35	3	5	5	7-1/2	CLU7-30E-22-*AH10A-A10-W
10...16	208	37	5	5	10	10	CLU7-30E-22-*AH16A-A10-W
14.5...20	260	38	5	5	10	15	CLU7-30E-22-*AH20A-A10-W
18...25	325	39	7-1/2	7-1/2	15	20	CLU7-30E-22-*AH25A-A10-W
23...32	416	41	7-1/2	7-1/2	15	25	CLU7-30E-22-*AH32A-A10-W
32...45	585	45	10	10	25	30	CLU7-37E-22-*AH45A-A10-W
32...45	585	45	10	15	30	30	CLU7-43E-22-*AH45A-A10-W ⑤

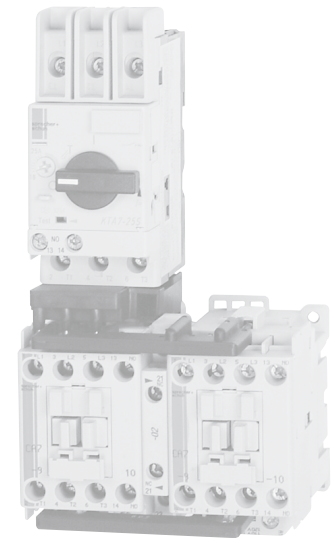

CLU7-9E-22-24E-AS25A-A10

Includes:

- KT7 Motor Controller with 1 NO Auxiliary Contact
- 1 CA7-9E...43E Contactors
- Connecting Module (Cat.# KT7-25[S or H]-PEC23)
- Terminal Adaptor for Type E/F Applications
- Reversing Power Wiring Kit (Cat.# CAUT7-PW23)
- Electrical / Mechanical Interlock
- Can mount on one DIN-rail

Optional: ③

- Type W Mounting Module is optional on 25S & 25H. Type W Module is standard on 45H models. See modifications on page F69.

Section Obsolete
See pages F1.40 - F1.55

Coil Codes ②

DC Coil Codes	Voltage
12E	12V
24E	24V
36E	36-48V
48E	48-72V
110E	110-125V
220E	220-250V

Horsepower ratings shown in the tables are for reference only. The final selection of the controller depends on the actual motor full load current and service factor.

- For motor with service factor less than 1.15. Use motor nameplate full load current times 0.9 and choose the motor starter with the appropriate current range. Example: Motor F.L.C. = 4.2A; S.F. = 1.0. - 4.2A x 0.9 = 3.78A. Select Catalog Number KTA7-25S-4A.

Ordering Instructions

Specify Catalog Number	
Replace (*) with Coil Code	See Coil Code table on this page for codes.

- ① KAIC Assembly Rating Index. See pages F73-F76 for Application Rating Guide.
- ② CLU7-9E...43E with electronic coils are not interchangeable with non-electronic DC or AC coils.
- ③ See Section A for limitations on adding auxiliaries to Electronic DC Coil contacts.
- ④ CLU7-30E...43E with KTA7-45H include Type W Mounting Modules for 35mm or 70mm DIN rail or Panel Mounting as necessary from page F17 To add Type W Mounting Modules for 25S or 25H models add -W to end of catalog number. See page F69 for modifications.
- ⑤ CLU7-43E supplied with (1) NO and (1) NC front mount auxiliary per contactor.
- ⑥ Catalog numbers and/or specific voltages (i.e. @ 575V) shaded in gray are suitable for Group Installation, per NEC 430-53C, because they are not Type E/F rated. See page F73 for ratings.

Non-Reversing EcomboPlus Starters with AC Coil, Series CA7 Contactors

Thermal Trip [A]	Magnetic Trip [A]	Index ①	Typical Three Phase [HP]				Catalog Number ②⑥
			200V	230V	460V	575V	
KTA7-25S — Standard Interrupting Capacity							
0.10...0.16	2.1	1	~	~	~	~	CK7-9-10-*AS0.16A-A11
0.16...0.25	3.3	2	~	~	~	~	CK7-9-10-*AS0.25A-A11
0.25...0.40	5.2	3	~	~	~	~	CK7-9-10-*AS0.4A-A11
0.40...0.63	8.2	4	~	~	~	~	CK7-9-10-*AS0.63A-A11
0.63...1	13	5	~	~	~	1/2	CK7-9-10-*AS1A-A11
1...1.6	21	6	~	~	1/2	3/4	CK7-9-10-*AS1.6A-A11
1.6...2.5	33	7	1/2	1/2	1	1-1/2	CK7-9-10-*AS2.5A-A11
2.5...4	52	8	3/4	3/4	2	3	CK7-9-10-*AS4A-A11
4...6.3	82	9	1	1-1/2	3	5	CK7-9-10-*AS6.3A-A11
6.3...10	130	11	2	3	5	7-1/2	CK7-12-10-*AS10A-A11
10...16	208	12	3	5	10	10	CK7-16-10-*AS16A-A11
14.5...20	260	15	5	5	10	15	CK7-23-10-*AS20A-A11
18.5...25	325	16	5	7-1/2	15	20	CK7-23-10-*AS25A-A11
KTA7-25H — High Interrupting Capacity							
1.6...2.5	33	17	1/2	1/2	1	1-1/2	CK7-9-10-*AH2.5A-A11
2.5...4	52	19	3/4	3/4	2	3	CK7-9-10-*AH4A-A11
4...6.3	82	22	1	1-1/2	3	5	CK7-9-10-*AH6.3A-A11
6.3...10	130	24	2	3	5	7-1/2	CK7-12-10-*AH10A-A11
10...16	208	28	3	5	10	10	CK7-16-10-*AH16A-A11
14.5...20	260	31	5	5	10	15	CK7-23-10-*AH20A-A11
18...25	325	33	5	7-1/2	15	20	CK7-23-10-*AH25A-A11
KTA7-45H — Higher Interrupting Capacity							
6.3...10	130	36	2	3	5	7-1/2	CK7-12-10-*AH10A-A11
10...16	208	37	3	5	10	10	CK7-16-10-*AH16A-A11
14.5...20	260	38	5	5	10	15	CK7-23-10-*AH20A-A11
18...25	325	39	7-1/2	7-1/2	15	20	CK7-30-11-*AH25A-A11
23...32	416	41	7-1/2	10	15	20	CK7-30-11-*AH32A-A11
32...45	585	45	10	10	25	30	CK7-37-11-*AH45A-A11
32...45	585	46	10	15	30	30	CK7-43-11-*AH45A-A11



Description ③
 The EcomboPlus starter is a factory assembly consisting of a KT7 contactor with 1 NO - 1 NC auxiliary and a CA7 contactor housed in a specially designed frame. All control wiring is pre-wired and brought out to a built-in terminal block, integral to the mounting frame. Terminal Adaptor (Cat.# KT7-25-TE1 or KT7-45-TE) is also included for Type E applications.

Section Obsolete
See pages F1.40 - F1.55

For applications above 45 amps please consider open type combination starters on page C59.

Coil Codes (*) ④⑥

AC Coil Code	Voltage Range	
	50 Hz	60 Hz
24Z	24V	24V
120	110V	120V
220W	200V-220V	208V-240V
277	240V	277V

Horsepower ratings shown in the tables are for reference only. The final selection of the controller depends on the actual motor full load current and service factor.

- For motor with service factor less than 1.15. Use motor nameplate full load current times 0.9 and choose the motor starter with the appropriate current range. Example: Motor F.L.C. = 4.2A; S.F. = 1.0. - 4.2A x 0.9 = 3.78A. Select Catalog Number KTA7-25S-4A.

- KAIC Assembly Rating Index. See pages F73-F76 for Application Rating Guide.
- See Factory Options on page F69 for additional auxiliary contact configurations.
 - KT7 supplied with (1) NO and (1) NC auxiliary contact
 - CK7-9...23 supplied with (1) NO auxiliary contact
 - CK7-30...37 supplied with (1) NO and (1) NC side mount auxiliary contact
 - CK7-43 supplied with (1) NO and (1) NC front mount auxiliary contact
- Mounting Options:
 - Screw Fixing
 - Snap Fixing on (1) or (2) 35 mm DIN Rails
 - Snap Fixing on (1) 75 mm DIN Rail
- Other voltages available, see Section A in this catalog.
- Catalog numbers and/or specific voltages (i.e. @ 575V) shaded in gray are suitable for Group Installation, per NEC 430-53C, because they are not Type E/F rated. See page F73 for ratings.
- Suffix -A11 uses front-mount KT7-PE1-11 300 VAC maximum control circuit. This assembly is not applicable with control circuits greater than 300 VAC.

Ordering Instructions

Specify Catalog Number	
Replace (*) with Coil Code	See Coil Code table on this page for codes.

Ecombo Circuit Controllers

Non-Reversing EcomboPlus Starters with Electronic DC Coil, Series CA7 Contactors ④⑤

Thermal Trip [A]	Magnetic Trip [A]	Index ①	Typical Three Phase [HP]				Catalog Number ②
			200V	230V	460V	575V	
KTA7-25S — Standard Interrupting Capacity							
0.10...0.16	2.1	1	~	~	~	~	CK7-9E-10-*AS0.16A-A11
0.16...0.25	3.3	2	~	~	~	~	CK7-9E-10-*AS0.25A-A11
0.25...0.40	5.2	3	~	~	~	~	CK7-9E-10-*AS0.4A-A11
0.40...0.63	8.2	4	~	~	~	~	CK7-9E-10-*AS0.63A-A11
0.63...1	13	5	~	~	~	1/2	CK7-9E-10-*AS1A-A11
1...1.6	21	6	~	~	1/2	3/4	CK7-9E-10-*AS1.6A-A11
1.6...2.5	33	7	1/2	1/2	1	1-1/2	CK7-9E-10-*AS2.5A-A11
2.5...4	52	8	3/4	3/4	2	3	CK7-9E-10-*AS4A-A11
4...6.3	82	9	1	1-1/2	3	5 ⑥	CK7-9E-10-*AS6.3A-A11 ⑥
6.3...10	130	11	2	3	5	7-1/2 ⑥	CK7-12E-10-*AS10A-A11 ⑥
10...16	208	12	3	5	10	10 ⑥	CK7-16E-10-*AS16A-A11 ⑥
14.5...20	260	15	5	5	10	15 ⑥	CK7-23E-10-*AS20A-A11 ⑥
18.5...25	325	16	5 ⑥	7-1/2 ⑥	15 ⑥	20 ⑥	CK7-23E-10-*AS25A-A11 ⑥
KTA7-25H — High Interrupting Capacity							
1.6...2.5	33	17	1/2	1/2	1	1-1/2	CK7-9E-10-*AH2.5A-A11
2.5...4	52	19	3/4	3/4	2	3	CK7-9E-10-*AH4A-A11
4...6.3	82	22	1	1-1/2	3	5	CK7-9E-10-*AH6.3A-A11
6.3...10	130	24	2	3	5	7-1/2	CK7-12E-10-*AH10A-A11
10...16	208	28	3	5	10	10	CK7-16E-10-*AH16A-A11
14.5...20	260	31	5	5	10	15 ⑥	CK7-23E-10-*AH20A-A11 ⑥
18...25	325	33	5 ⑥	7-1/2 ⑥	15 ⑥	20 ⑥	CK7-23E-10-*AH25A-A11 ⑥
KTA7-30E-11 — High Interrupting Capacity							
6.3...10	130	34	2	3	5	10	CK7-30E-11-*AH10A-A11
10...16	208	37	3	5	10	10	CK7-30E-11-*AH16A-A11
14.5...20	260	38	5	5	10	15	CK7-30E-11-*AH20A-A11
18...25	325	39	7-1/2	10	15	20	CK7-30E-11-*AH25A-A11
23...32	416	41	10	15	20	25	CK7-30E-11-*AH32A-A11
32...45	585	42	15	20	25	30	CK7-37E-11-*AH45A-A11
32...45	585	43	10	15	30	30	CK7-43E-11-*AH45A-A11



Description ③

- The EcomboPlus starter is a factory assembly consisting of a KT7 controller with 1 NO and 1 NC auxiliary and a CA7-9E...43E contactor housed in a specially designed frame. All control wiring is pre-wired and brought out to a built-in terminal block, integral to the mounting frame. Terminal Adaptor (Cat.# KT7-25-TE1 or KT7-45-TE) is also included for Type E applications.

Section Obsolete
See pages F1.40 - F1.55

For applications above 45 amp, please consider open type combination starters on page C59.

Coil Codes ④

DC Coil Codes	Voltage
12E	12V
24E	24V
36E	36-48V
48E	48-72V
110E	110-125V
220E	220-250V

Horsepower ratings shown in the tables are for reference only. **The final selection of the controller depends on the actual motor full load current and service factor.**

- For motor with service factor less than 1.15. Use motor nameplate full load current times 0.9 and choose the motor starter with the appropriate current range. Example: Motor F.L.C. = 4.2A; S.F. = 1.0. - 4.2A x 0.9 = 3.78A. Select Catalog Number KTA7-25S-4A.

- ① KAIC Assembly Rating Index. See pages F73-F76 for Application Rating Guide.
- ② See Factory Options on page F69 for additional auxiliary contact configurations.
 - CK7-9...23E supplied with (1) NO and (1) NC auxiliary contact
 - CK7-9...23E supplied with (1) NO auxiliary contact
 - CK7-30...37E supplied with (1) NO and (1) NC side mount auxiliary contact
 - CK7-43E supplied with (1) NO and (1) NC front mount auxiliary contact
- ③ Mounting Options:
 - Screw Fixing
 - Snap Fixing on (1) or (2) 35 mm DIN Rails
 - Snap Fixing on (1) 75 mm DIN Rail
- ④ CK7-9E...43E with electronic coils are not interchangeable with non-electronic DC or AC coils.
- ⑤ See pages A47 for limitations on adding auxiliaries to Electronic DC Coil contactors.
- ⑥ Catalog numbers and/or specific voltages (i.e. @ 575V) shaded in gray are suitable for Group Installation, per NEC 430-53C, because they are not Type E/F rated. See page F73 for ratings.

Ordering Instructions

Specify Catalog Number	
Replace (*) with Coil Code	See Coil Code table on this page for codes.

Reversing EcomboPlus Starters with AC Coil, Series CA7 Contactors

Thermal Trip [A]	Magnetic Trip [A]	Index ①	Typical Three Phase [HP]				Catalog Number ②⑥
			200V	230V	460V	575V	
KTA7-25S — Standard Interrupting Capacity							
0.10...0.16	2.1	1	~	~	~	~	CKU7-9-22-*AS0.16A-A11
0.16...0.25	3.3	2	~	~	~	~	CKU7-9-22-*AS0.25A-A11
0.25...0.40	5.2	3	~	~	~	~	CKU7-9-22-*AS0.4A-A11
0.40...0.63	8.2	4	~	~	~	~	CKU7-9-22-*AS0.63A-A11
0.63...1	13	5	~	~	~	1/2	CKU7-9-22-*AS1A-A11
1...1.6	21	6	~	~	1/2	3/4	CKU7-9-22-*AS1.6A-A11
1.6...2.5	33	7	1/2	1/2	1	1-1/2	CKU7-9-22-*AS2.5A-A11
2.5...4	52	8	3/4	3/4	2	3	CKU7-9-22-*AS4A-A11
4...6.3	82	9	1	1-1/2	3	5 ⑤	CKU7-9-22-*AS6.3A-A11 ⑤
6.3...10	130	11	2	3	5	7-1/2 ⑤	CKU7-12-22-*AS10A-A11 ⑤
10...16	208	12	3	5	10	10 ⑤	CKU7-16-22-*AS16A-A11 ⑤
14.5...20	260	15	5	5	10	15 ⑤	CKU7-23-22-*AS20A-A11 ⑤
18.5...25	325	16	5 ⑤	7-1/2 ⑤	15 ⑤	20 ⑤	CKU7-23-22-*AS25A-A11 ⑤
KTA7-25H — High Interrupting Capacity							
1.6...2.5	33	17	1/2	1/2	1	1-1/2	CKU7-9-22-*AH2.5A-A11
2.5...4	52	19	3/4	3/4	2	3	CKU7-9-22-*AH4A-A11
4...6.3	82	22	1	1-1/2	3	5	CKU7-9-22-*AH6.3A-A11
6.3...10	130	24	2	3	5	7-1/2	CKU7-12-22-*AH10A-A11
10...16	208	28	3	5	10	10	CKU7-16-22-*AH16A-A11
14.5...20	260	31	5	5	10	15 ⑤	CKU7-23-22-*AH20A-A11 ⑤
18...25	325	33	5	7-1/2	15	20	CKU7-23-22-*AH25A-A11

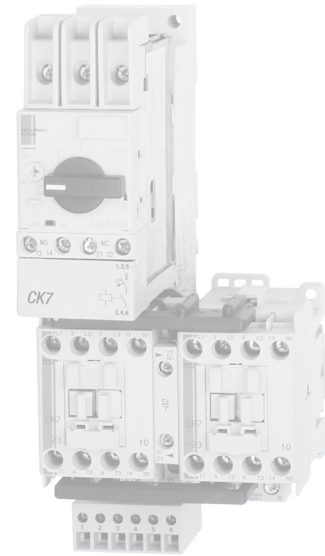

Description ③

The EcomboPlus Reversing starter is a factory assembly consisting of a KT contactor with 1 NO - 1 NC auxiliary and reversing CA7 contactors housed in a specially designed frame. All control wiring is pre-wired and brought out to a built-in terminal block, integral to the mounting frame. A Reversing Power Wiring Kit (Cat.# CAUT7-PW23) is used to wire the reversing contactors. An electrical and mechanical interlock is also provided (Cat.# CM7-02), as well as a Terminal Adaptor (Cat.# KT7-25-TE1) for Type E applications.

Horsepower ratings shown in the table are for reference only. The final selection of the controller depends on the actual motor full load current and service factor.

- For motor with service factor less than 1.15. Use motor nameplate full load current times 0.9 and choose the motor starter with the 0.9hp current range. Example: Motor F.L.C. = 4.2A; S.F. = 1.0; 4.2A x 0.9 = 3.78A. Select Catalog Number KTA7-5S-4.

Coil Codes (*) ④⑥

AC Coil Code	Voltage Range	
	50 Hz	60 Hz
24Z	24V	24V
120	110V	120V
220W	200V-220V	208V-240V
277	240V	277V

Ordering Instructions

Specify Catalog Number	
Replace (*) with Coil Code	See Coil Code table on this page for codes.

- KAIC Assembly Rating Index. See pages F73-F76 for Application Rating Guide.
- See Factory Options on page F69 for additional auxiliary contact configurations.
 - KT7 supplied with (1) NO and (1) NC auxiliary contact
 - CKU7 supplied with (2) NO auxiliary contact
 - CM7-02 interlock supplied with (2) NC auxiliary contacts
- Mounting Options:
 - Screw Fixing
 - Snap Fixing on (1) or (2) 35 mm DIN Rails
 - Snap Fixing on (1) 75 mm DIN Rail
- Other voltages available, see Section A in this catalog.
- Catalog numbers and/or specific voltages (i.e. @ 575V) shaded in gray are suitable for Group Installation, per NEC 430-53C, because they are not Type E/F rated. See page F73 for ratings.
- Suffix -A11 uses front-mount KT7-PE1-11 300 VAC maximum control circuit. This assembly is not applicable with control circuits greater than 300 VAC.

Ecombo Circuit Controllers

Section Obsolete
See pages F1.40 - F1.55

CL8 and CL7 Modifications ④⑤

Modification	Change Last Digit in Catalog Number to: ①
KT7 Auxiliary (Front Mount 300VAC max.) and Trip Contacts	
Auxiliary Contact 1 NO (CL8 only)	A10
Auxiliary Contact 1 NC	A01
Auxiliary Contact 1 NO + 1 NC	A11
Auxiliary Contact 2 NO	A20
1 NO SC or OL + 1 NC Auxiliary Contact	T10A01
1 NO SC or OL + 1 NO Auxiliary Contact	T10A10
KT7 Auxiliary (Side Mount 600VAC max.) and Trip Contacts	
Auxiliary Contact 1 NO + 1 NC	AS11
Auxiliary Contact 2 NO	AS20
1 NC SC or OL + 1 NO Auxiliary Contact	R10
1 NO SC or OL + 1 NC Auxiliary Contact	R11

CL8 and CL7 Additions ④⑤

Add desired suffix AFTER auxiliary contact option code.

Addition	Add Suffix to Catalog Number:
Accessories	
Electronic Interfaces (CA7)	-JE ③
Surge Suppressor RC (CA7, CA8)	-R
Surge Suppressor Varistor (CA7, CA8)	-V
Surge Suppressor Diode (CA7, CA8)	-D
Lockable Twist Knob (KT7) - Black	-KN
Lockable Twist Knob (KT7) - Red/Yellow	-KRY
Type W Mounting Module for CL7...23 includes 45mm short module (W-3248) ②	-W
Type W Mounting Module for CLU7...23 includes 45mm (W-32849) and 54mm (W-32490) short module ②	-W
Additional CA7 Contactor Auxiliaries (Side Mount)	
1 NC	-S01
1 NO	-S10
1 NO + 1 NC	-S11
2 NO	-S20
Additional CA7 & CA8 Contactor Auxiliaries (Front Mount)	
1 NO + 1 NC	-F11
2 NO	-F20
2 NO + 2 NC	-F22
Additional KT7 Auxiliaries (Side Mount) ⑤	
2 NC	-AS02
2 NO	-AS20
1 NO + 1 NC	-AS11
Additional KT7 Trip Contacts (Side Mount) ⑤	
1 NO SC or OL + 1 NO SC	-R00
1 NO SC or OL + 1 NC SC	-R01
1 NC SC or OL + 1 NO SC	-R10
1 NC SC or OL + 1 NC SC	-R11
1 NO SC + 1 NC SC	-M11

- ① For CL8, change last digit "X" to one of the modifications listed. Example: CL8-09-10-*****-AS0.16A-**X** changes to CL8-09-10-*****-AS0.16A-**A10**. For CL7, change last digits "A10" to one of the modifications listed. Example: CL7-9-10-*****-AS0.16A-**A10** changes to CL7-9-10-*****-AS0.16A-**A01**.
- ② CL7/CLU7-30...43 include all Type W Mounting Modules necessary from page F17.

CK7 Modifications ⑤

Modification	Change Last Digits (A11) in Catalog Number to: ①
CK7 Auxiliary (Front Mount 300VAC max.) and Trip Contacts	
Auxiliary Contact 2 NO	A20
1 NO SC or OL + 1 NC Auxiliary Contact	T10A01
1 NO SC or OL + 1 NO Auxiliary Contact	T10A10

CK7 Additions ④⑤

Add desired suffix AFTER auxiliary contact option code.

Addition	Add Suffix to Catalog Number:
Accessories	
Electronic Interfaces (CA7)	-JE
Surge Suppressor RC (CA7)	-R
Surge Suppressor Varistor (CA7)	-V
Surge Suppressor Diode (CA7)	-D
Socket and Plug for Control Circuit	-SP
Lockable Twist Knob (KT7) - Black	-KN
Lockable Twist Knob (KT7) - Red/Yellow	-KRY
Additional Contactor Auxiliaries (Side Mount)	
1 NC	-S01
1 NO	-S10
1 NO + 1 NC	-S11
2 NO	-S20
Additional CA7 Auxiliaries (Side Mount) ⑤	
2 NC	-AS02
2 NO	-AS20
1 NO + 1 NC	-AS11
Additional KT7 Trip Contacts (Side Mount) ⑤	
1 NO SC or OL + 1 NO SC	-R00
1 NO SC or OL + 1 NC SC	-R01
1 NC SC or OL + 1 NO SC	-R10
1 NC SC or OL + 1 NC SC	-R11
1 NO SC + 1 NC SC	-M11

- ③ CRI7E-24 will be used. CRI7E-12 by special order only.
- ④ See pages A47 for limitations on adding auxiliaries to Electronic DC Coil contactors.
- ⑤ Front Mount Auxiliary contacts have a maximum rating of 300VAC. Side Mounted Auxiliaries have a maximum rating of 600VAC where there would be no connection to the terminal block provided.

F
ECombo Circuit Controllers

Section Obsolete
See pages F1.40 - F1.55

Non-Reversing 3-Component Ecombo Starters with AC Coil ③⑤

Rated Oper. Current [A] ⑥	Overload Adj. Range [A]	Magnetic Trip [A]	Index ①	Typical Three Phase [HP] ⑥				Catalog Number ②④⑦
				200V	230V	460V	575V	
KTB7-25S — Standard Interrupting Capacity								
0.40	0.1...0.5	5.2	3B	~	~	~	~	CLT7-9-*B2S0.4-A10-D1AB
0.40	0.1...0.5	5.2	3B	~	~	~	~	CLT7-9-*B2S0.4-A10-EAB
1.0	0.2...1.0	13	5B	~	~	~	1/2	CLT7-9-*B2S1-A10-D1BB
1.0	0.2...1.0	13	5B	~	~	~	1/2	CLT7-9-*B2S1-A10-EBB
2.5	1.0...5.0	33	7B	1/2	1/2	1	~	CLT7-9-*B2S2.5-A10-D1CB
2.5	1.0...5.0	33	7B	1/2	1/2	1	~	CLT7-9-*B2S2.5-A10-ECB
KTB7-25H — High Interrupting Capacity								
2.5	1.0...5.0	33	17B	1/2	1/2	1	~	CLT7-9-*B2H2.5-A10-D1CB
2.5	1.0...5.0	33	17B	1/2	1/2	1	~	CLT7-9-*B2H2.5-A10-ECB
2.5	1.0...5.0	33	18B	1/2	1/2	1	1-1/2	CLT7-23-*B2H2.5-A10-D1CB
2.5	1.0...5.0	33	18B	1/2	1/2	1	1-1/2	CLT7-23-*B2H2.5-A10-ECB
4.0	1.0...5.0	52	21B	3/4	3/4	2	3	CLT7-23-*B2H4-A10-D1CB
4.0	1.0...5.0	52	21B	3/4	3/4	2	3	CLT7-23-*B2H4-A10-ECB
10	5.1...27	130	27B	2	3	5	7-1/2	CLT7-30-*B2H10-A10-EED
16	5.1...27	208	30B	3	5	10	10	CLT7-30-*B2H10-A10-EED
25	5.1...27	325	34B	5	7-1/2	15	~	CLT7-30-*B2H10-A10-EED
KTB7-45H — High Interrupting Capacity								
25	5.1...27	325	39B	5	7-1/2	15	~	CLT7-30-*B4H25-A10-EED
32	9...45	416	41B	7-1/2	10	20	20	CLT7-37-*B4H32-A10-EFD
32	9...45	416	42B	7-1/2	10	20	20	CLT7-37-*B4H32-A10-EFD
45	9...45	585	45B	10	10	25	30	CLT7-37-*B4H45-A10-EFD
45	9...45	585	46B	10	15	30	30	CLT7-43-*B4H45-A10-EFD

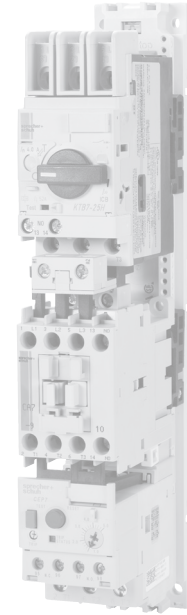

Includes:

- KTB7 Motor Controller
- CA7 Contactor (AC)
- CEP7 Solid State Overload Relay
- KT7-PE10 PNC Connectors
- Terminal Adaptor for Type E Applications
- Mounting Modules for 25A or 45A Frame Units as required from page F17
- See page F72 for Factory Options

Section Obsolete
See pages F1.40 - F1.55

Coil Codes (*) ②

AC Coil Code	Voltage Range	
	50 Hz	60 Hz
24Z	24V	24V
120	110V	120V
220W	200-220V	208-240V
277	240V	277V
415	400-415V	~
480 ⑦	440V	480V
600 ⑦	550V	600V

- KAIC Assembly Rating Index. See pages F73-F76 for Application Rating Guide.
- Other voltages available, see Section A in this catalog.
- All CLT7 contactors are supplied with Auxiliary Contacts as follows:
 CLT7-9...23 (1) NO Internal Mount
 CLT7-30...37 (1) NO Side Mount
 CLT7-43 (1) NO & (1) NC Front Mount
 All KTB7s are supplied with (1) NO auxiliary contact (A10), which should be used in series with the NC contact on the overload (95-96).
- See page F72 for CEP7 Overload Relay information.
- Horsepower ratings shown in tables are for reference only. **The final selection of the controller and solid state overload relay depends on the actual motor full load current and service factor.**
- The KTB7 Motor Circuit Controller is designed and tested to protect a motor circuit in case of a short circuit. A separate Sprecher + Schuh CEP7-EE_ overload relay with selectable trip class should be used to protect the motor against overload.
 In Applications with motor starting times exceeding 10 seconds (heavy duty starting) the rated operational current (I_e) of the motor FLA must be multiplied by the following factors for selection of the KTB7 Motor Circuit Controller KTB7-25S, KTB7-25H/32H and KTB7-45H.
 Trip classes according to UL 508 Section 52 and IEC 60947-4-1
 CLASS 10 = 1.0, CLASS 15 = 1.22, CLASS 20 = 1.42, CLASS 25 = 1.58, CLASS 30 = 1.73
 The maximum number of motor starts in 25 cycles/hour with a minimum OFF-time of 120 seconds between cycles. This additional calculation and selecting a larger frame size is necessary to compensate (dissipate) the increased heat resulting from long acceleration applications effecting the rated operational current of the KTB7.
- Catalog number includes -A10 which uses front-mount KT7-PE1-10 300 VAC maximum control circuit. For control circuits greater than 300 VAC use side-mount KT7-PA1-11 and change -A10 to -AS11 (example CLT7-9-*B2S0.4-AS11-D1AB) Add \$66.43 or see options on page F72.

Ordering Instructions

Specify Catalog Number	
Replace (*) with Coil Code	See Coil Code table on this page for codes.

Reversing 3-Component Ecombo Starters with AC Coil ③④⑤

Rated Oper. Current [A] ⑥	Overload Adj. Range [A]	Magnetic Trip [A]	Index ①	Typical Three Phase [HP]				Catalog Number ②④⑦
				200V	230V	460V	575V	
KTB7-25S — Standard Interrupting Capacity								
0.40	0.1...0.5	5.2	3B	~	~	~	~	CLUT7-9-*B2S0.4-A10-D1AB
0.40	0.1...0.5	5.2	3B	~	~	~	~	CLUT7-9-*B2S0.4-A10-EAB
1.0	0.2...1.0	13	5B	~	~	~	1/2	CLUT7-9-*B2S1-A10-D1BB
1.0	0.2...1.0	13	5B	~	~	~	1/2	CLUT7-9-*B2S1-A10-EBB
2.5	1.0...5.0	33	7B	1/2	1/2	1	~	CLUT7-9-*B2S2.5-A10-D1CB
2.5	1.0...5.0	33	7B	1/2	1/2	1	~	CLUT7-9-*B2S2.5-A10-ECB
KTB7-25H — High Interrupting Capacity								
2.5	1.0...5.0	33	17B	1/2	1/2	1	~	CLUT7-9-*B2H2.5-A10-D1CB
2.5	1.0...5.0	33	17B	1/2	1/2	1	~	CLUT7-9-*B2H2.5-A10-ECB
2.5	1.0...5.0	33	18B	1/2	1/2	1	1-1/2	CLUT7-23-*B2H2.5-A10-D1CB
2.5	1.0...5.0	33	18B	1/2	1/2	1	1-1/2	CLUT7-23-*B2H2.5-A10-ECB
4.0	1.0...5.0	52	21B	3/4	3/4	2	3	CLUT7-23-*B2H4-A10-D1CB
4.0	1.0...5.0	52	21B	3/4	3/4	2	3	CLUT7-23-*B2H4-A10-ECB
10	5.1...27	130	27B	2	3	5	7-1/2	CLUT7-30-*B2H7-A10-EED
16	5.1...27	208	30B	3	5	10	10	CLUT7-30-*B2H10-A10-EED
25	5.1...27	325	34B	5	7-1/2	15	~	CLUT7-30-*B2H25-A10-EED
KTB7-45H — High Interrupting Capacity								
25	5.1...27	325	39B	5	7-1/2	15	20	CLUT7-30-*B4H25-A10-EED
32	9...45	416	42B	7-1/2	10	20	20	CLUT7-30-*B4H32-A10-EFD
32	9...45	416	42P	7-1/2	10	20	20	CLUT7-37-*B4H32-A10-EFD
45	9...45	585	45B	10	10	20	~	CLUT7-37-*B4H45-A10-EFD
45	9...45	585	46B	10	10	20	~	CLUT7-43-*B4H45-A10-EFD

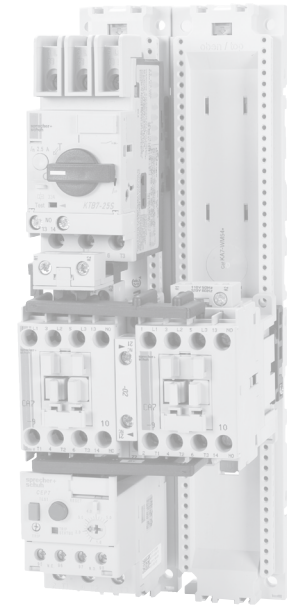

Includes:

- KTB7 Motor Controller
- CAU7 Reversing Contactor (AC)
- CEP7 Solid State Overload Relay
- RT1 PSC and PNC Connectors
- Terminal Adaptor for Type E Applications
- Mounting Modules for 25A or 45A Frame Units as required from page F17
- See page F72 for Factory Options

Section Obsolete
See pages F1.40 - F1.55

Coil Codes (*) ②

AC Coil Code	Voltage Range	
	50 Hz	60 Hz
24Z	24V	24V
120	110V	120V
220W	200-220V	208-240V
277	240V	277V
415	400-415V	~
480 ⑦	440V	480V
600 ⑦	550V	600V

Ordering Instructions

Specify Catalog Number	
Replace (*) with Coil Code	See Coil Code table on this page for codes.

- ① KAIC Assembly Rating Index. See pages F73-F76 for Application Rating Guide.
- ② Other voltages available, see Section A in this catalog.
- ③ All CLUT7 are supplied with Auxiliary Contacts for customer use as follows;
 - CLUT7-9...23 (1) NO Internal Mount
 - CLUT7-30...37 (1) NO Side Mount
 - CLUT7-43 (1) NO & (1) NC Front Mount
 - CM7-02 interlock (2) NC (Electrical Interlocks)
 All KTB7s are supplied with (1) NO auxiliary contact (A10), which should be used in series with the NC contact on the overload (95-96).
- ④ All CAU7 reversing contactors are supplied with CM7-02, including (2) NC contacts for electronic interlocking (not available for customer use).
- ⑤ Horsepower ratings shown in tables are for reference only. **The final selection of the controller and solid state overload relay depends on the actual motor full load current and service factor.**
- ⑥ The KTB7 Motor Circuit Controller is designed and tested to protect a motor circuit in case of a short circuit. A separate Sprecher + Schuh CEP7-EE_ overload relay with selectable trip class should be used to protect the motor against overload.

In Applications with motor starting times exceeding 10 seconds (heavy duty starting) the rated operational current (I_o) of the motor FLA must be multiplied by the following factors for selection of the KTB7 Motor Circuit Controller KTB7-25S, KTB7-25H/32H and KTB7-45H.

Trip classes according to UL 508 Section 52 and IEC 60947-4-1
 CLASS 10 = 1.0, CLASS 15 = 1.22, CLASS 20 = 1.42, CLASS 25 = 1.58, CLASS 30 = 1.73

The maximum number of motor starts in 25 cycles/hour with a minimum OFF-time of 120 seconds between cycles. This additional calculation and selecting a larger frame size is necessary to compensate (dissipate) the increased heat resulting from long acceleration applications effecting the rated operational current of the KTB7.
- ⑦ Catalog number includes -A10 which uses front-mount KT7-PE1-10 300 VAC maximum control circuit. For control circuits greater than 300 VAC use side-mount KT7-PA1-11 and change -A10 to -AS11 (example CLUT7-9-*B2S0.4-AS11-D1AB) Add \$66.43 or see options on page F72.

CLT7/CLUT7 Modifications ⑩

Modification	Change "X" Digit in Catalog Number to: ⑥
KT7 Auxiliary (Front Mount 300VAC max.) and Trip Contacts	
Auxiliary Contact 1 NO + 1 NC	A11
Auxiliary Contact 2 NO	A20
1 NO SC + 1 NC Auxiliary Contact	T10A01
1 NO SC + 1 NO Auxiliary Contact	T10A10
KT7 Auxiliary (Side Mount 300VAC max.) and Trip Contacts	
Auxiliary Contact 1 NO + 1 NC	AS11
Auxiliary Contact 2 NO	AS20
1 NC SC + 1 NO Auxiliary Contact	R10
1 NC SC + 1 NC Auxiliary Contact	R11

CLT7/CLUT7 Additions ⑩

Addition	Add Suffix to end of Catalog Number:
Accessories	
Electronic Interfaces	-JE
Surge Suppressor RC	-R
Surge Suppressor Varistor	-V
Surge Suppressor Diode	-D
Lockable Twist Knob (KT7) - Black	-KN
Lockable Twist Knob (KT7) - Red/Yellow	-KRY
Additional CA7 Contactor Auxiliaries (Side Mount) ⑩	
1 NC	-S10
1 NO	-S11
1 NO + 1 NC	-S11
2 NO	-S20
Additional CA7 Contactor Auxiliaries (Front Mount) ⑩	
1 NO + 1 NC	-F10
2 NO	-F20
2 NO + 2 NC	-F22
Additional KT7 Auxiliaries (Side Mount) ⑩⑩	
2 NC	-AS02
2 NO	-AS20
1 NO + 1 NC	-AS11
Additional KT7 Trip Contacts (Side Mount) ⑩	
1 NO SC + 1 NO SC	-R00
1 NO SC + 1 NC SC	-R01
1 NC SC + 1 NC SC	-R11

CEP7 Solid State Overload Relay ①②③

(As specified in the CLT7/CLUT7 Catalog Number)

For use with contactor...	Amp Range	Last Suffix in Catalog Number ⑤	Catalog Number (of Overload Relay used)
3-Phase / Manual Reset / Class 10			
CA7-9...CA7-23	0.1...0.5	D1AB	CEP7-ED1AB
	0.2...1.0	D1BB	CEP7-ED1BB
	1.0...5.0	D1CB	CEP7-ED1CB
3-Phase / Auto or Manual / Adjustable Trip Class 10, 15, 20 & 30			
CA7-9...CA7-23	0.1...0.5	EAB	CEP7-EEAB
	0.2...1.0	EBB	CEP7-EEBB
	1.0...5.0	ECB	CEP7-EECB
CA7-30...CA7-43	5.4...27	EED	CEP7-EEED
	9...45	EFD	CEP7-EEFD

CEP7 Side Mount Module Addition ④⑦⑨

Addition	For use with...	Add Suffix to end of Catalog Number
Remote Reset Module	Side-mount to any CEP7-EE_	-ERR
Jam Protection and Remote Reset Module	Side-mount to any CEP7-EE_	-EJM
Ground Fault Protection and Remote Reset Module ⑥	Side-mount to any CEP7-EE_	-EGF
Ground Fault/Jam Protection and Remote Reset Module ⑥	Must use with CEP7-CBCT_ Current Sensor	-EGJ
PTC Thermistor Relay and Remote Reset Module	Side-mount to any CEP7-EE_	-EPT
Ethernet Network Communication Module	Side-mount to any CEP7-EE_	-ETN

Section Obsolete
See pages F1.40 - F1.55

- ① 3-phase CEP7 units are only designed for 3∅ applications.
- ② The reset time of a CEP7 set in the automatic mode is approximately 120 seconds.
- ③ CEP7 Overload relays do not work with Variable Frequency Drives or any Sprecher + Schuh Softstarter with braking options.
- ④ Side mount modules must have 24 - 240V, 47 - 63HZ or DC applied to terminals A1 and A2 for control power. See Section B for connection details.
- ⑤ CEP7 Overloads shown are UL approved. Other overload combinations may be possible. Contact your Sprecher+Schuh representative.
- ⑥ ATTENTION: The CEP7 Overload relay is not a ground fault circuit interrupter for

- personnel protection as defined in Article 100 of the NEC.
- ⑦ See Section B for Technical Data, Wiring, and DIP Switch set up.
- ⑧ For CLT7, change digit "A10" to one of the modifications listed. Example: Change CLT7-9-*B2S0.4-A10-D1AB to CLT7-9-*B2S0.4-A11-D1AB.
- ⑨ Side mount auxiliaries and CEP7 modules change the width dimension of the device. See Dimensions in this section for more information.
- ⑩ Front Mount Auxiliary contacts have a maximum rating of 300VAC. Side Mounted Auxiliaries have a maximum rating of 600VAC. See page F12 for additional information.

KT7 Assembly – Application Rating Chart (Ratings are dependent on type of application) ①

Rating Index	Assembly Components		Manual Controller or Group Installation				Combination Motor Controller (Type F)				Self-Protected Combination Motor Controller (Type E)	
			480V		600V		480Y / 277V		600Y / 347V		480Y / 277V	600Y / 347V
	KT7	Minimum Contactor Size	Type 1 KAIC	Type 2 KAIC	Type 1 KAIC	Type 2 KAIC	Type 1 KAIC	Type 2 KAIC	Type 1 KAIC	Type 2 KAIC	Type E KAIC	Type E KAIC
KT7 + CA7 UL Assemblies (CL7 / CLU7/ CK7 / CKU7)												
1	KTA7-25S-0.16A	CA7-9	65	65	47	47	65	65	47	47	65	47
2	KTA7-25S-0.25A	CA7-9	65	65	47	47	65	65	47	47	65	47
3	KTA7-25S-0.4A	CA7-9	65	65	47	47	65	65	47	47	65	47
4	KTA7-25S-0.63A	CA7-9	65	65	47	47	65	65	47	47	65	47
5	KTA7-25S-1A	CA7-9	65	65	47	47	65	65	47	47	65	47
6	KTA7-25S-1.6A	CA7-9	65	65	47	47	65	65	47	47	65	47
7	KTA7-25S-2.5A	CA7-9	65	65	30	10	65	65	30	10	65	~
8	KTA7-25S-4A	CA7-9	65	50	30	~	65	~	30	~	~	~
--	KTA7-25S-4A	CA7-30	65	~	30	~	65	~	30	~	~	~
9	KTA7-25S-6.3A	CA7-9	65	50	30	~	65	~	~	~	~	~
11	KTA7-25S-10A	CA7-9	65	50	30	~	65	~	~	~	~	~
12	KTA7-25S-16A	CA7-12	30	~	30	~	65	~	~	~	~	~
14	KTA7-25S-16A	CA7-30	30	~	30	~	65	~	~	~	~	~
15	KTA7-25S-20A	CA7-16	30	~	30	~	10	~	~	~	~	~
16	KTA7-25S-25A	CA7-23	30	~	30	~	~	~	~	~	~	~
--	KTA7-32S-29A	CA7-30	30	10	30	~	~	~	~	~	~	~
--	KTA7-32S-32A	CA7-37	30	10	30	~	~	~	~	~	~	~
17	KTA7-25H-2.5A	CA7-9	65	65	30	~	65	65	30	10	65	~
18	KTA7-25H-2.5A	CA7-9	65	65	30	~	65	65	30	30	65	30
19	KTA7-25H-4A	CA7-9	65	65	30	~	65	65	30	~	~	~
21	KTA7-25H-4A	CA7-30	65	65	30	30	65	65	30	30	65	30
22	KTA7-25H-6.3A	CA7-9	65	65	30	~	65	65	30	~	~	~
23	KTA7-25H-6.3A	CA7-30	65	65	30	~	65	65	30	30	65	30
24	KTA7-25H-10A	CA7-9	65	65	30	~	65	65	30	~	~	~
27	KTA7-25H-10A	CA7-30	65	65	30	~	65	65	30	30	65	30
28	KTA7-25H-16A	CA7-12	65	65	30	~	65	65	30	~	~	~
30	KTA7-25H-16A	CA7-30	65	65	30	~	65	65	30	30	65	30
31	KTA7-25H-20A	CA7-23	65	65	30	~	65	65	~	~	~	~
32	KTA7-25H-20A	CA7-30	65	65	30	~	65	65	~	~	65	~
33	KTA7-25H-25A	CA7-23	65	65	30	~	65	65	~	~	~	~
34	KTA7-25H-25A	CA7-30	65	65	30	~	65	65	~	~	65	~
--	KTA7-32H-29A	CA7-30	65	65	30	~	~	~	~	~	~	~
--	KTA7-32H-32A	CA7-37	65	65	30	~	~	~	~	~	~	~
36	KTA7-45H-10A	CA7-30	65	65	30	30	65	65	30	30	65	30
37	KTA7-45H-16A	CA7-30	65	65	30	30	65	65	30	30	65	30
38	KTA7-45H-20A	CA7-30	65	65	30	30	65	65	30	30	65	30
39	KTA7-45H-25A	CA7-30	65	65	30	30	65	65	30	30	65	30
41	KTA7-45H-32A	CA7-30	65	65	30	30	65	65	30	30	65	30
45	KTA7-45H-45A	CA7-37	65	65	18	10	65	65	~	~	65	~
46	KTA7-45H-45A	CA7-43	65	65	18	10	65	65	~	~	65	~

Section Obsolete
See pages F1.40 - F1.55

F
ECombo Circuit Controllers

Gray type indicates non-cataloged assembly. Contact your Sprecher + Schuh representative for information.

① The ratings in these tables assume connection between components are made with Sprecher + Schuh Connection Modules.
Engineering Practice allows wire connection as an alternative.

KT7 Assembly – Application Rating Chart (Ratings are dependent on type of application) ①②

Rating Index	Assembly Components		Manual Controller or Group Installation				Combination Motor Controller (Type F)				Self-Protected Combination Motor Controller (Type E)	
			480V		600V		480Y / 277V		600Y / 347V		480Y / 277V	600Y / 347V
	KT7	Minimum Contactor Size	Type 1 KAIC	Type 2 KAIC	Type 1 KAIC	Type 2 KAIC	Type 1 KAIC	Type 2 KAIC	Type 1 KAIC	Type 2 KAIC	Type E KAIC	Type E KAIC
KTC7 + CA7 UL Assemblies ①												
①	KTC7-25S-0.16A	CA7-9...23	65	65	47	47	65	65	47	47	65	47
	KTC7-25S-0.25A	CA7-9...23	65	65	47	47	65	65	47	47	65	47
	KTC7-25S-0.4A	CA7-9...23	65	65	47	47	65	65	47	47	65	47
	KTC7-25S-0.63A	CA7-9...23	65	65	47	47	65	65	47	47	65	47
	KTC7-25S-1A	CA7-9...23	65	65	47	47	65	65	47	47	65	47
	KTC7-25S-1.6A	CA7-9...23	65	65	30	10	65	65	30	10	65	~
	KTC7-25S-2.5A	CA7-9...23	65	50	30	~	65	~	30	~	~	~
	KTC7-25S-2.5A	CA7-23	65	50	30	~	65	~	~	~	~	~
	KTC7-25S-4A	CA7-9...23	65	50	30	~	65	~	~	~	~	~
	KTC7-25S-6.3A	CA7-12...23	65	50	30	~	65	~	~	~	~	~
	KTC7-25S-10A	CA7-12...43	30	~	30	~	30	~	~	~	~	~
KTC7-25S-16A	CA7-23	30	~	30	~	~	~	~	~	~	~	
①	KTC7-25H-16A	CA7-23	65	65	30	~	65	65	~	~	~	~
	KTC7-25H-16A	CA7-30	65	65	30	~	65	65	~	~	65	~
	KTC7-25H-20A	CA7-23	65	65	30	~	65	65	~	~	~	~
	KTC7-25H-20A	CA7-30	65	65	30	~	65	65	~	~	65	~
①	KTC7-45H-25A	CA7-30	65	65	30	~	65	65	30	30	65	30
	KTC7-45H-32A	CA7-37	65	65	10	~	65	65	~	~	65	~

Section Obsolete
See pages F1.40 - F1.55

F
ECombo Circuit Controllers

① Non-cataloged assemblies. Contact your Sprecher+ Schuh representative for information.
 ② The ratings in these tables assume connection between components are made with Sprecher + Schuh Connection Modules. Engineering Practice allows wire connection as an alternative.

KT7 Assembly – Application Rating Chart (Ratings are dependent on type of application) ①

Rating Index	Assembly Components		Manual Controller or Group Installation				Combination Motor Controller (Type F)				Self-Protected Combination Motor Controller (Type E)	
			480V		600V		480Y / 277V		600Y / 347V		480Y / 277V	600Y / 347V
	KT7	Minimum Contactor Size	Type 1 KAIC	Type 2 KAIC	Type 1 KAIC	Type 2 KAIC	Type 1 KAIC	Type 2 KAIC	Type 1 KAIC	Type 2 KAIC	Type E KAIC	Type E KAIC
KT7 + CA8 UL Assemblies (CL8 / CLU8)												
--	KTA7-25S-(0.16A...1A)	CA8-05	65	65	47	~	65	~	47	~	~	~
--	KTA7-25S-1.6A	CA8-05	65	~	47	~	65	~	47	~	~	~
--	KTA7-25S-(2.5A...4A)	CA8-05	65	~	30	~	65	~	30	~	~	~
--	KTA7-25S-6.3A	CA8-05	65	~	~	~	65	~	~	~	~	~
1M	KTA7-25S-0.16A	CA8-09	65	65	47	~	65	65	47	~	~	~
2M	KTA7-25S-0.25A	CA8-09	65	65	47	~	65	65	47	~	~	~
3M	KTA7-25S-0.4A	CA8-09	65	65	47	~	65	65	47	~	~	~
4M	KTA7-25S-0.63A	CA8-09	65	65	47	~	65	65	47	~	~	~
5M	KTA7-25S-1A	CA8-09	65	65	47	~	65	65	47	~	~	~
6M	KTA7-25S-1.6A	CA8-09	65	65	47	~	65	65	47	~	~	~
7M	KTA7-25S-2.5A	CA8-09	65	~	30	~	65	~	30	~	~	~
8M	KTA7-25S-4A	CA8-09	65	~	30	~	65	~	30	~	~	~
9M	KTA7-25S-6.3A	CA8-09	65	~	30	~	65	~	30	~	~	~
10M	KTA7-25S-10A	CA8-09	65	~	30	~	65	~	30	~	~	~
--	KTA7-25S-(2.5A...4A)	CA8-12	65	~	~	~	65	~	30	~	~	~
--	KTA7-25S-6.3A	CA8-12	65	~	~	~	65	~	~	~	~	~
11M	KTA7-25S-10A	CA8-09	65	~	~	~	65	~	~	~	~	~
12M	KTA7-25S-16A	CA8-12	30	~	30	~	30	~	~	~	~	~

Section Obsolete
See pages F1.40 - F1.55

F
ECombo Circuit Controllers

Rating Index	Assembly Components		Self-Protected Combination Motor Controller (Type E KAIC) ②			
	KT7	Minimum Contactor Size	208V-240V	480Y / 277V	600Y / 347V	
KT7 + CA7 UL Assemblies (CLT7 / CLU7)						
3B	KTB7-25S-0.4A	CA7-9	CEP7-ED1AB	65	65	47
3B	KTB7-25S-0.4A	CA7-9	CEP7-EEAB	65	65	47
5B	KTB7-25S-1A	CA7-9	CEP7-ED1BB	65	65	47
5B	KTB7-25S-1A	CA7-9	CEP7-EEBB	65	65	47
7B	KTB7-25S-2.5A	CA7-9	CEP7-ED1CB	65	65	~
7B	KTB7-25S-2.5A	CA7-9	CEP7-EECB	65	65	~
17B	KTB7-25H-2.5A	CA7-9	CEP7-ED1CB	65	65	~
17B	KTB7-25H-2.5A	CA7-9	CEP7-EECB	65	65	~
18B	KTB7-25H-2.5A	CA7-23	CEP7-ED1CB	65	65	30
18B	KTB7-25H-2.5A	CA7-23	CEP7-EECB	65	65	30
21B	KTB7-25H-4A	CA7-23	CEP7-ED1CB	65	65	30
21B	KTB7-25H-4A	CA7-23	CEP7-EECB	65	65	30
27B	KTB7-25H-10A	CA7-30	CEP7-EEED	65	65	30
30B	KTB7-25H-16A	CA7-30	CEP7-EEED	65	65	30
34B	KTB7-25H-25A	CA7-30	CEP7-EEED	65	65	~
39B	KTB7-45H-25A	CA7-30	CEP7-EEED	65	65	30
41B	KTB7-45H-32A	CA7-30	CEP7-EEFD	65	65	30
42B	KTB7-45H-32A	CA7-37	CEP7-EEFD	65	65	30
45B	KTB7-45H-45A	CA7-37	CEP7-EEFD	65	65	~
46B	KTB7-45H-45A	CA7-43	CEP7-EEFD	65	65	~

Definition of Type 2 short-circuit coordination per UL508

- The contactor or starter must not endanger persons or plant in the event of a short-circuit.
- The contactor or starter must be suitable for continuous use.
- No damage to the overload relay or other parts may occur with the exception of welding of the contactor or starter contacts if these can be easily separated without appreciable deformation (such as with a screwdriver).

In the event of a short-circuit, fast-opening, strong current-limiting KT7 motor protectors make it possible to build economical, fully short-circuit coordinated starter combinations in accordance with UL508E, Type 2 coordination.

Gray type indicates non-cataloged assembly. Contact your Sprecher+ Schuh representative for information.

① The ratings in these tables assume connection between components are made with Sprecher + Schuh Connection Modules. Engineering Practice allows wire connection as an alternative.

② UL approved, File 125316.

KT7 Assembly – IEC Application Rating Chart (Ratings are dependent on type of application) ①

Rating Index	Assembly Components		IEC kW Ratings for Standard Motors, 1500 rpm Max. kW, 50Hz ②				Max. Short-Circuit Current [kA] IEC Type 1 Coordination				Max. Short-Circuit Current [kA] IEC Type 2 Coordination			
	KT7	Min. Contactor	230V	400V	500V	690V	230V	400V	500V	690V	230V	400V	500V	690V
KT7 + CA7 IEC Assemblies (CL7 / CLU7/ CK7 / CKU7)														
1	KTA7-25S-0.16A	CA7-9	~	~	0.06	0.06	100	100	65	50	100	100	65	50
2	KTA7-25S-0.25A	CA7-9	0.02	0.06	0.06	0.12	100	100	65	50	100	100	65	50
3	KTA7-25S-0.4A	CA7-9	0.06	0.09	0.12	0.18	100	100	65	50	100	100	65	50
4	KTA7-25S-0.63A	CA7-9	0.09	0.18	0.18	0.37	100	100	65	50	100	100	65	50
5	KTA7-25S-1A	CA7-9	0.12	0.25	0.37	0.55	100	100	65	50	100	100	65	50
6	KTA7-25S-1.6A	CA7-9	0.25	0.55	0.75	1.1	100	100	65	50	100	100	65	50
7	KTA7-25S-2.5A	CA7-9	0.55	0.75	1.1	1.8	100	65	50	8	65	50	50	8
8	KTA7-25S-4A	CA7-9	0.75	1.5	2.2	3	100	50	50	8	50	50	~	~
9	KTA7-25S-6.3A	CA7-9	1.5	2.2	3	4	100	50	50	4	50	50	~	~
10	KTA7-25S-10A	CA7-9	2.2	4	4	~	100	65	50	~	50	50	~	~
11	KTA7-25S-10A	CA7-12	2.2	4	5.5	5.5	100	65	50	4	50	50	50	~
--	KTA7-25S-10A	CA7-16	2.2	4	5.5	7.5	100	65	50	4	50	50	50	~
12	KTA7-25S-16A	CA7-12	4	5.5	~	~	100	65	~	~	50	50	~	~
--	KTA7-25S-16A	CA7-16	4	7.5	7.5	~	100	50	10	~	50	~	~	~
14	KTA7-25S-16A	CA7-23	4	7.5	10	10	100	50	10	~	50	50	~	~
15	KTA7-25S-20A	CA7-23	4	10	11	~	50	15	~	~	15	~	~	~
16	KTA7-25S-25A	CA7-23	6.3	11	13	~	50	15	~	~	15	~	~	~
17	KTA7-25H-2.5A	CA7-9	0.55	0.75	1.1	8	100	100	50	10	100	100	50	10
18	KTA7-25H-2.5A	CA7-23	0.55	0.75	1.1	1.1	100	100	50	10	100	100	50	10
19	KTA7-25H-4A	CA7-9	0.75	1.5	2.2	3	100	100	50	10	100	100	50	~
21	KTA7-25H-4A	CA7-23	0.75	1.5	2.2	3	100	100	50	10	100	100	50	50
22	KTA7-25H-6.3A	CA7-9	1.5	2.2	3	4	100	100	50	50	100	100	50	~
--	KTA7-25H-10A	CA7-9	2.2	4	4	~	100	65	50	~	100	65	~	~
24	KTA7-25H-10A	CA7-12	2.2	4	5.5	5.5	100	100	65	50	100	100	65	~
--	KTA7-25H-10A	CA7-16	2.2	4	5.5	7.5	100	100	65	50	100	100	65	50
--	KTA7-25H-16A	CA7-12	4	5.5	~	~	100	65	~	~	65	65	~	~
28	KTA7-25H-16A	CA7-16	4	7.5	7.5	~	100	65	50	~	65	65	50	~
--	KTA7-25H-16A	CA7-23	4	7.5	10	10	100	65	50	6	65	65	50	~
31	KTA7-25H-20A	CA7-23	4	10	11	~	65	65	25	~	65	65	25	~
33	KTA7-25H-25A	CA7-23	6.3	11	13	~	65	50	25	~	65	50	25	~
KT7 + CA8 IEC Assemblies (CL8 / CLU8)														
1M	KTA7-25S-0.16A	CA8-09	~	0.02	~	~	100	65	65	65	65	65	~	~
2M	KTA7-25S-0.25A	CA8-09	0.02	0.06	0.06	~	100	65	65	65	65	65	~	~
3M	KTA7-25S-0.4A	CA8-09	0.06	0.09	0.12	~	100	65	65	65	65	65	~	~
4M	KTA7-25S-0.63A	CA8-09	0.09	0.18	0.18	~	100	65	65	65	65	65	~	~
5M	KTA7-25S-1A	CA8-09	0.12	0.25	0.37	~	100	65	65	65	65	65	~	~
6M	KTA7-25S-1.6A	CA8-09	0.25	0.55	0.75	~	100	65	65	10	65	65	~	~
7M	KTA7-25S-2.5A	CA8-09	0.55	0.75	1.1	~	100	65	65	8	65	65	~	~
8M	KTA7-25S-4A	CA8-09	0.75	1.5	2.2	~	100	65	65	8	50	50	~	~
9M	KTA7-25S-6.3A	CA8-09	1.5	2.2	2.2	~	100	65	65	4	~	~	~	~
10M	KTA7-25S-10A	CA8-09	2.2	4	4	~	100	65	65	4	~	~	~	~
11M	KTA7-25S-10A	CA8-12	2.2	4	4	~	100	65	65	4	~	~	~	~
12M	KTA7-25S-16A	CA8-12	4	5.5	~	~	100	50	50	3	~	~	~	~

Gray type indicates non-cataloged assembly. Contact your Sprecher+ Schuh representative for information.

① The ratings in these tables assume connection between components are made with Sprecher + Schuh Connection Modules.
Engineering Practice allows wire connection as an alternative.

② kW ratings shown in the table are for reference. Final selection of the starter depends upon the actual motor full-load current and service factor.

Section Obsolete
See pages F1.40 - F1.55

EcomboPlus Combination Starters

CK7-9...23

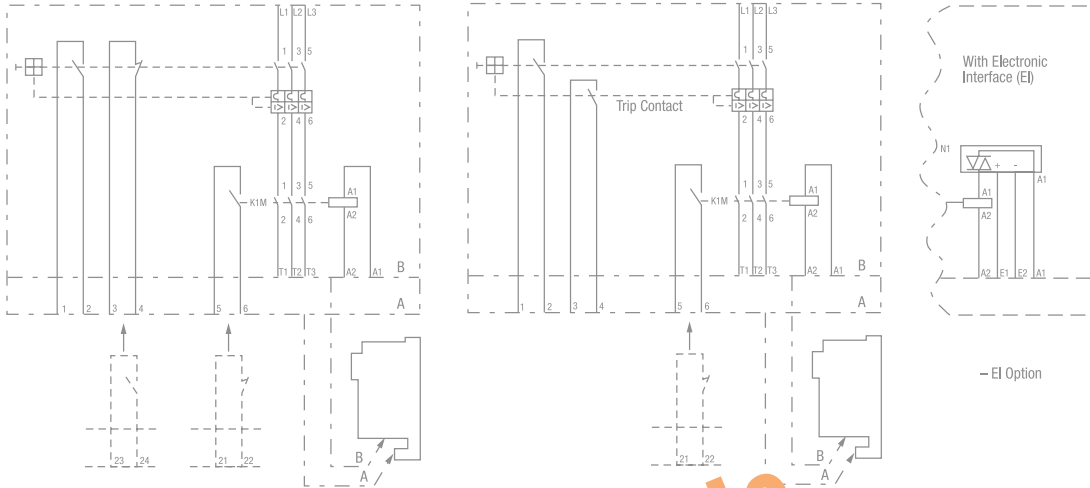

Section Obsolete
See pages F1.40 - F1.55

CK7-10...43

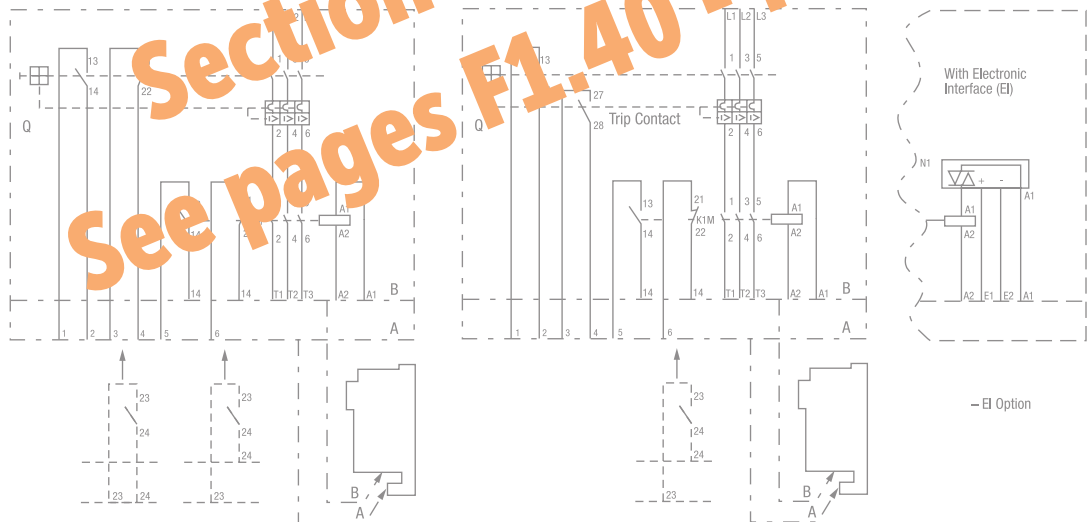

F
Ecombo Circuit Controllers

3-Component ECombo Starters

CLT7-9...43 Typical Diagram

CUSTOMER TO SUPPLY PROPER BRANCH
CIRCUIT PROTECTION AS PER LOCAL CODES.
(USE 75°C COPPER WIRE ONLY)

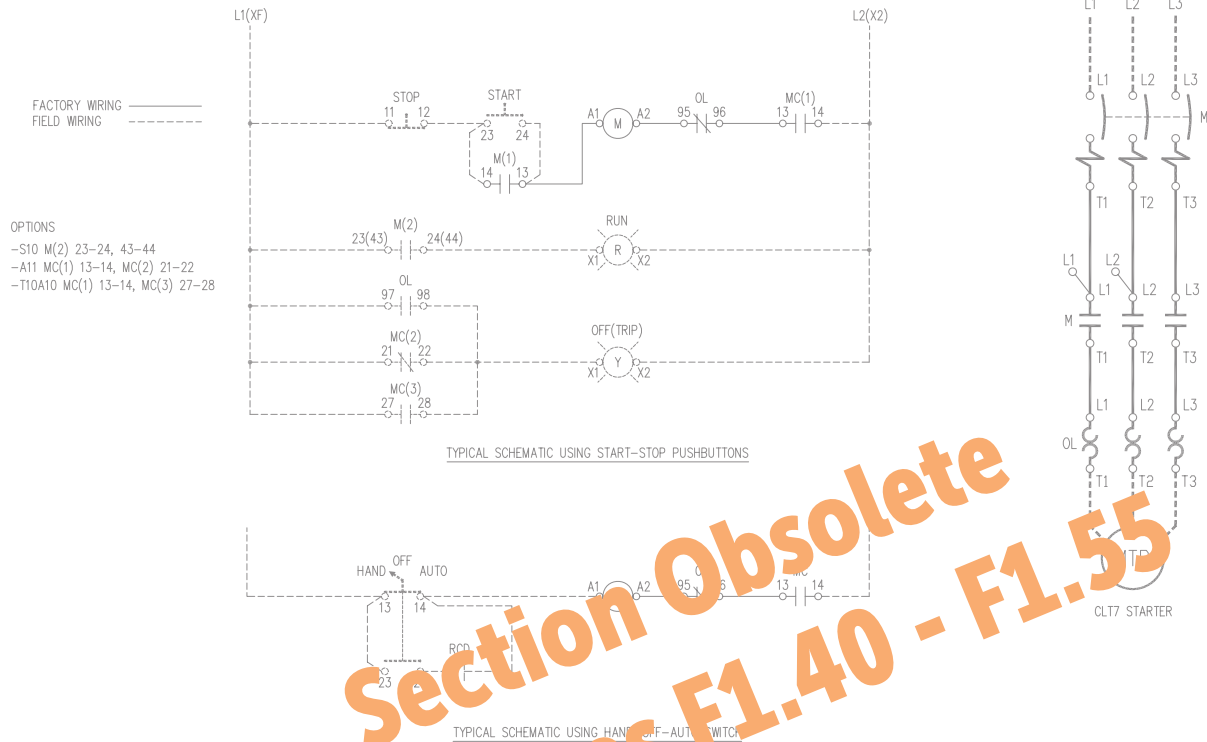

NOTES:

- 1) RCD: STANDS FOR REMOTE CONTROL DEVICE BY CUSTOMER.
- 2) MC: KTB7 MOTOR CONTROLLER.

Section Obsolete
See pages F1.40 - F1.55

F
ECombo Circuit Controllers

Ecombo Combination Starters

CL8 and CLU8 Ecombo Starters with KT7-25S

Dimensions are in millimeters (inches). Dimensions not intended for manufacturing purposes.

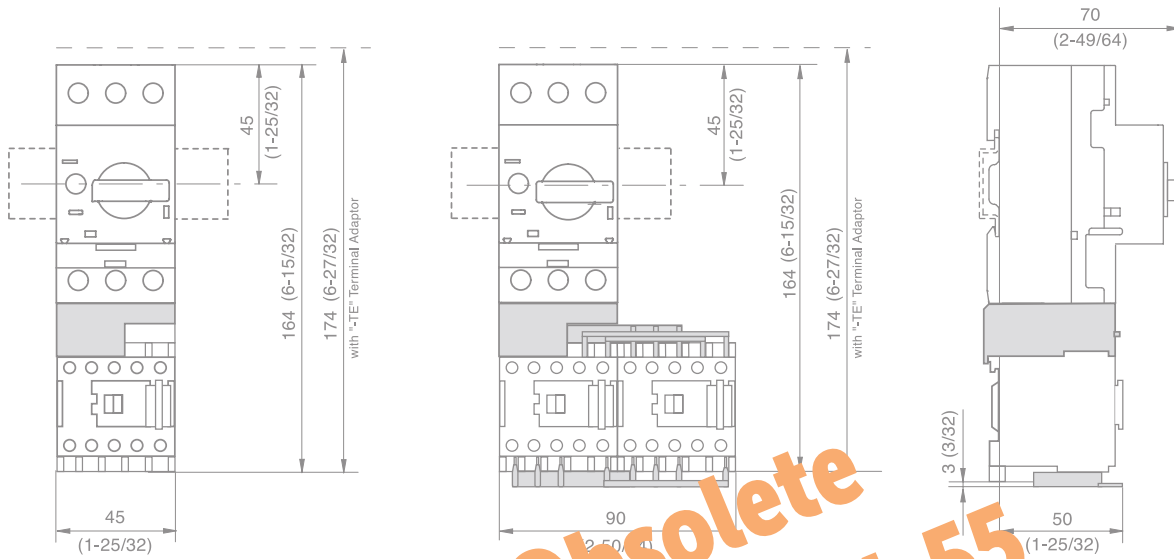

CL7-9...23(E) and CLU7-9...23(E) Ecombo Starters with KT7-25S

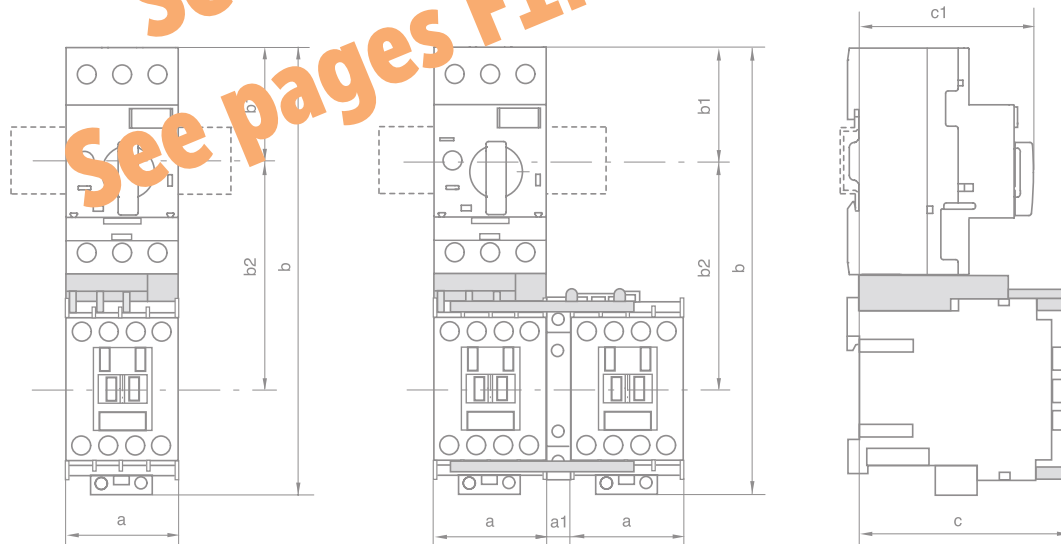

Catalog Number ❶	a	a1	b	b1	b2	c	c1
CL7-9(E)...CL7-23(E)	45 (1-25/32)	0	178 (7)	45 (1-25/32)	~	83.5 (3-19/64)	70 (2-49/64)
CL7-9(E)...CL7-23(E) with -TE1 Terminal Adaptor	45 (1-25/32)	0	188 (7-13/32)	55 (2-5/32)	~	83.5 (3-19/64)	70 (2-49/64)
CLU7-9(E)...CLU7-23(E)	45 (1-25/32)	10 (25/64)	178 (7)	45 (1-25/32)	~	83.5 (3-19/64)	70 (2-49/64)
CLU7-9(E)...CLU7-23(E) with -TE1 Terminal Adaptor	45 (1-25/32)	10 (25/64)	188 (7-13/32)	55 (2-5/32)	~	83.5 (3-19/64)	70 (2-49/64)

❶ Dimensions shown apply to AC coil contactors, or 12V or 24V Electronic DC coil contactors. Add 24 mm (1-25/32") to accommodate back pack on 36V...250V Electronic DC coils. See page A86 for details.

Ecombo Combination Starters

CL7-30...43(E) and CLU7-30...43(E) Ecombo Starters with KT7-45H

Dimensions are in millimeters (inches). Dimensions not intended for manufacturing purposes.

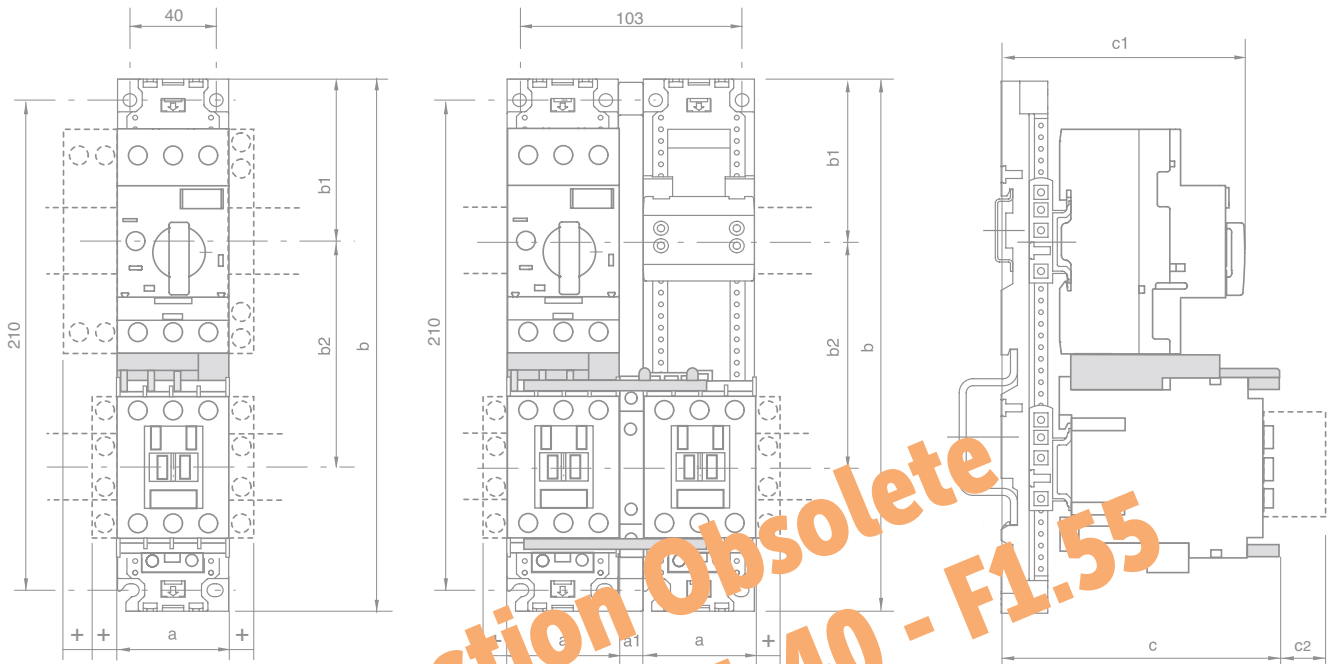

Catalog Number ①②	a	a1	b	b1	b2	c	c1	c2	+
CL7-30(E)	54 (2.125)	~	103 (4.05)	69 (2.72)	105 (4.30)	122.5 (4.82)	134.5 (5.29)	~	9
CL7-37(E)	54 (2.125)	~	103 (4.05)	69 (2.72)	105 (4.30)	122.5 (4.82)	134.5 (5.29)	~	9
CL7-43(E)	54 (2.125)	~	228 (8.97)	69 (2.72)	105 (4.30)	136 (5.35)	137 (5.39)	31 (1.22)	9
CLU7-30(E)	54 (2.125)	9	228 (8.97)	69 (2.72)	105 (4.30)	122.5 (4.82)	134.5 (5.29)	~	9
CLU7-37(E)	54 (2.125)	9	228 (8.97)	69 (2.72)	105 (4.30)	122.5 (4.82)	134.5 (5.29)	~	9
CLU7-43(E)	54 (2.125)	9	228 (8.97)	69 (2.72)	105 (4.30)	136 (5.35)	137 (5.39)	31 (1.22)	9

- ① CL7-30...43(E) and CLU7-30...43(E) include W-32490 Mounting Module. CLU7 includes W-32955 Spacer.
- ② Dimensions shown apply to AC coil contactors, or 12V or 24V Electronic DC coil contactors. Add 24 mm (1-25/32") to accommodate back pack on 36V... 250V Electronic DC coils. See page A86 for details.

Section Obsolete
See pages F1.40 - F1.55

EcomboPlus Combination Starters

CK7-9...23 and CKU7-9...23 EcomboPlus Starters

Dimensions are in millimeters (inches). Dimensions not intended for manufacturing purposes.

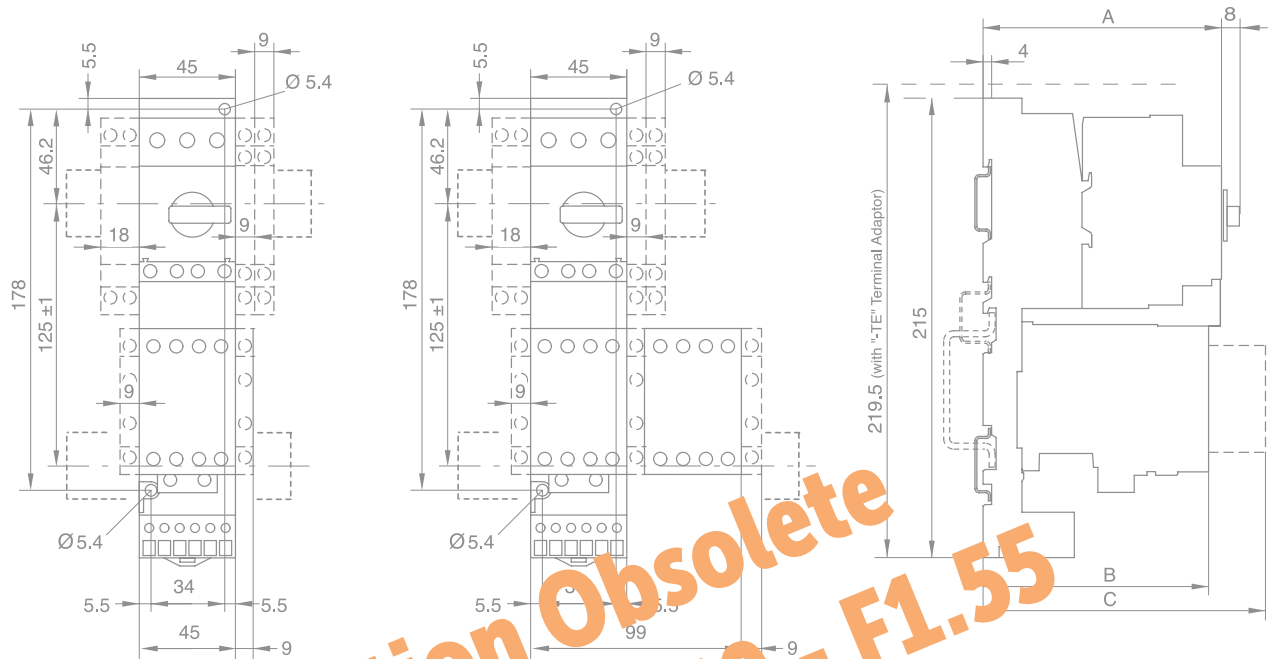

Section Obsolete
See pages F1.40 - F1.55

		A (mm)	B (mm)		
Direct on-line starters ①					
CK7-9(E)	KT7-25S	112	107	→	CA7-PV, CS7-PV CZE-7, CZA7 CV7
CK7-12(E)					
CK7-16(E)					
CK7-23(E)					
Reversing Starters					
CKU7-9	KT7-25S	112	107	→	CA7-PV, CS7-PV CZE7, CZA7 CV7
CKU7-12					
CKU7-16					
CKU7-23					

① Dimensions shown apply to AC coil contactors, or 12V or 24V Electronic DC coil contactors. Add 24 mm (1-25/32") to accommodate back pack on 36V...250V Electronic DC coils. See page A86 for details.

EcomboPlus Combination Starters

CK7-9...23

Dimensions are in millimeters (inches). Dimensions not intended for manufacturing purposes.

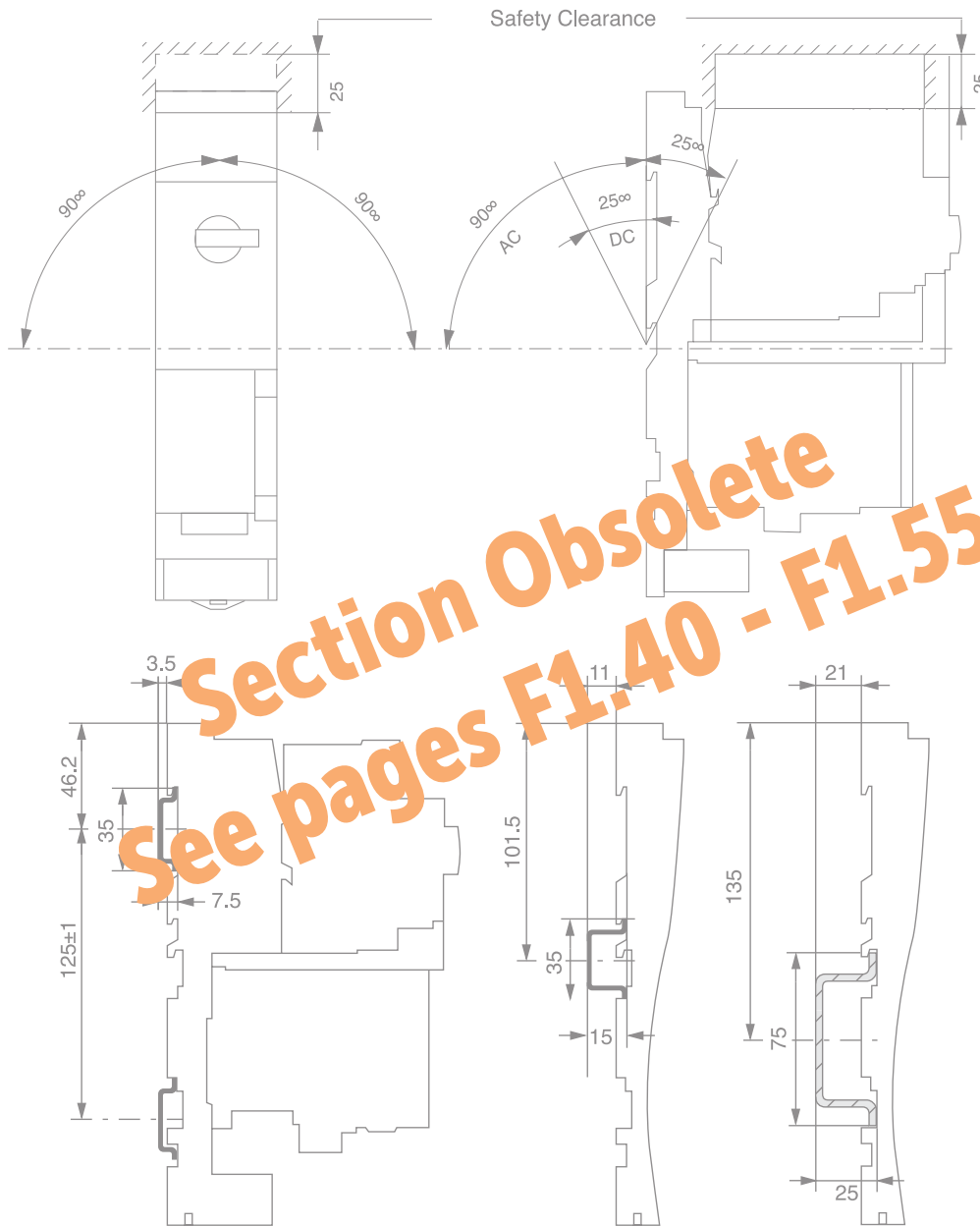

Section Obsolete
See pages F1.40 - F1.55

F
 Ecombo Circuit Controllers

EcomboPlus Combination Starters

CK7-30...37

Dimensions are in millimeters (inches). Dimensions not intended for manufacturing purposes.

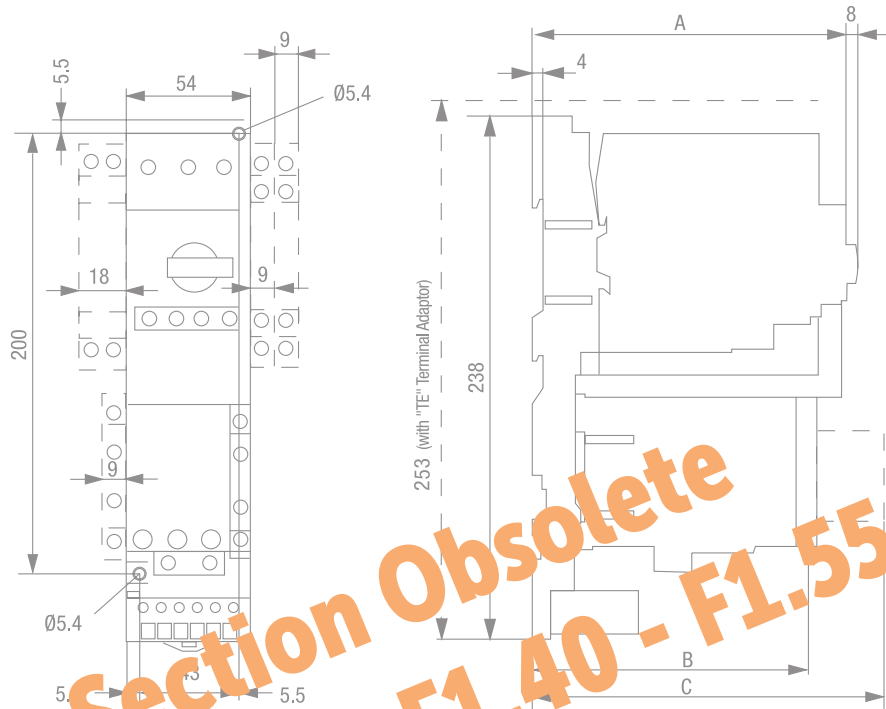

Section Obsolete
See pages F1.40 - F1.55

		A (mm)		B (mm)		C (mm)	
CK7-30(E) ①	KT7-45H	135	124			CA7-PV	154.5
CK7-37(E) ①						CZE7	173.5
						CV7	176.5

① Dimensions shown apply to AC coil contactors, or 12V or 24V Electronic DC coil contactors. Add 24 mm (1-25/32") to accommodate back pack on 36V...250V Electronic DC coils. See page A86 for details.

EcomboPlus Combination Starters

CK7-43

Dimensions are in millimeters (inches). Dimensions not intended for manufacturing purposes.

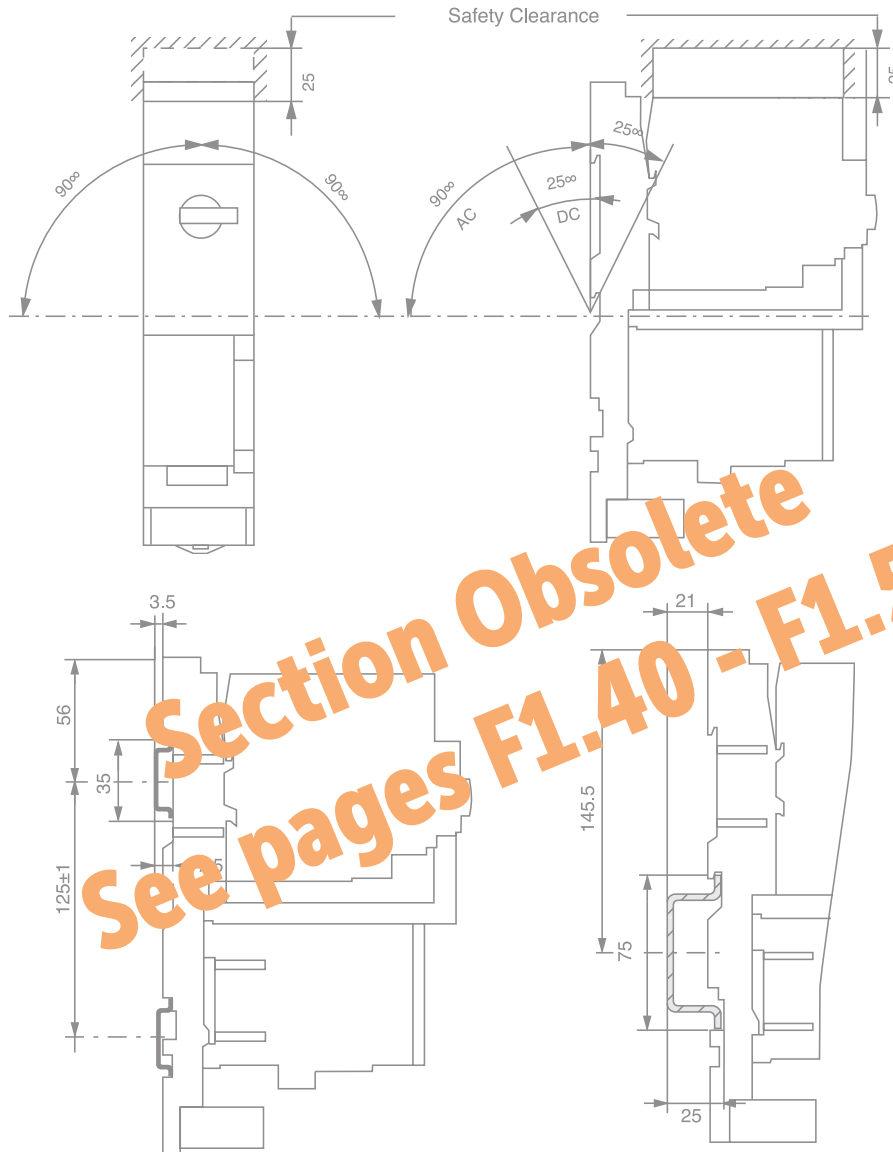

Section Obsolete
See pages F1.40 - F1.55

See previous page for dimensions A , B & C locations

		A (mm)	B (mm)
		135	118.5

	C (mm)
	157
	176
	179

① Dimensions shown apply to AC coil contactors, or 12V or 24V Electronic DC coil contactors. Add 24 mm (1-25/32") to accommodate back pack on 36V...250V Electronic DC coils. See page A86 for details.

Non-Reversing Three Component Combination Starters ③

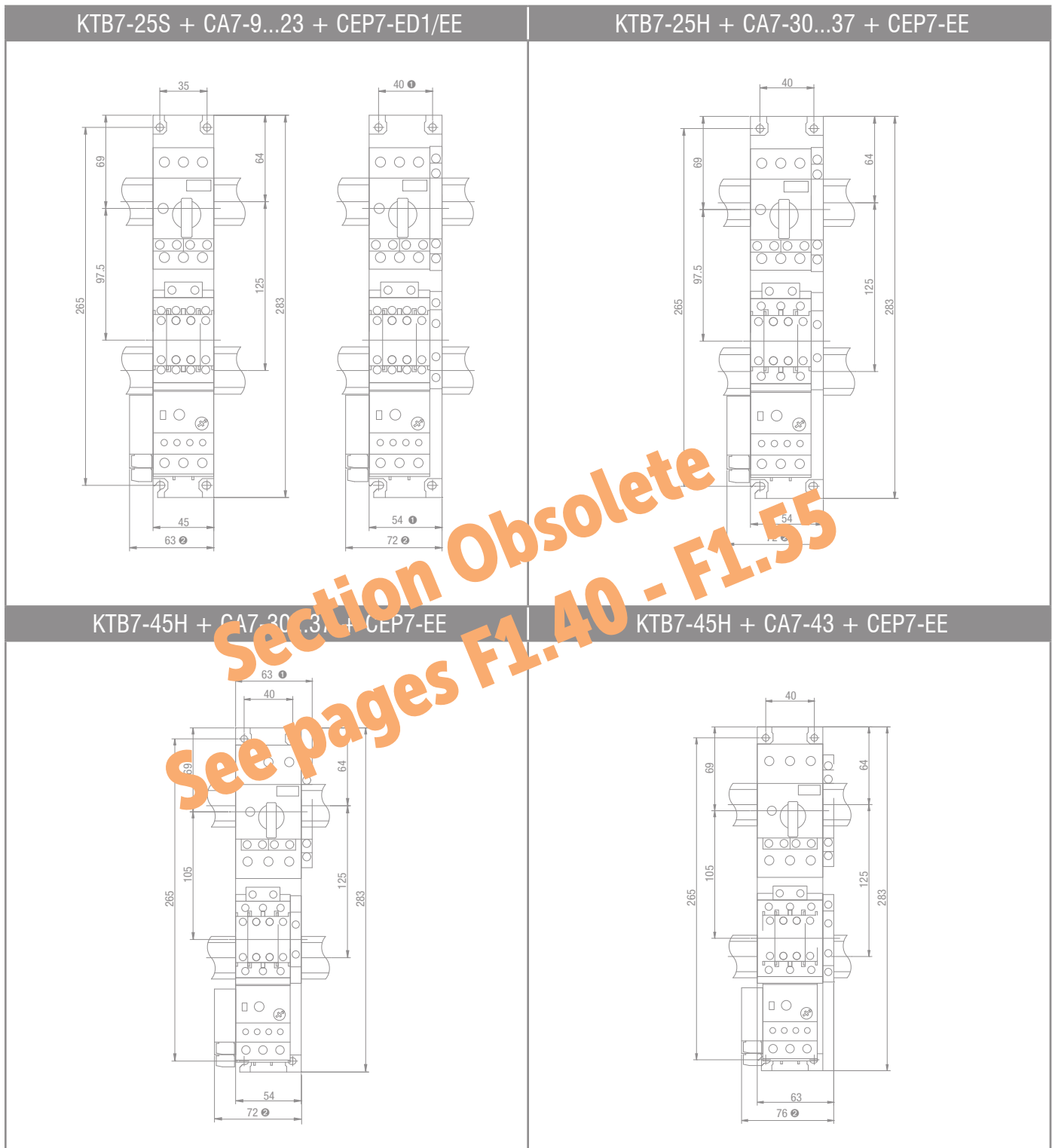

Section Obsolete
See pages F1.40 - F1.55

Dimensions are in millimeters (inches). Dimensions not intended for manufacturing purposes.

- ① With additional side mount auxiliary or trip contact(s)
- ② With CEP7-E* Side Mount Modules
- ③ Dimensions shown apply to AC coil contactors, or 12V or 24V Electronic DC coil contactors. Add 24 mm (1-25/32") to accommodate back pack on 36V...250V Electronic DC coils. See page A86 for details.

Reversing Three Component Combination Starters ②

KTB7-25S + CAU7-9...37 + CEP7-ED1/EE

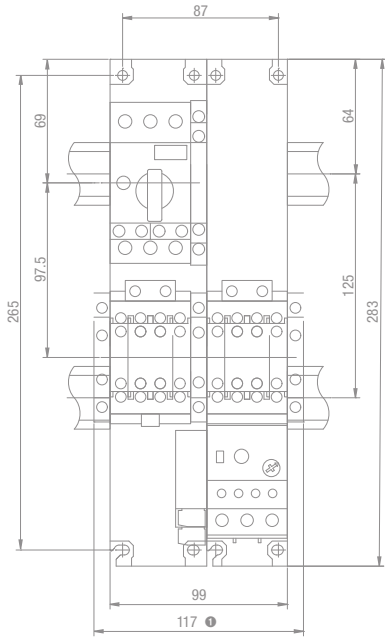

KTB7-45H + CA7-30...37 + CEP7-EE

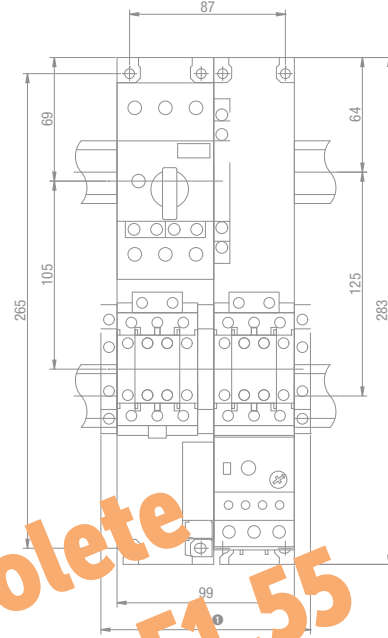

KTB7-45H + CA7-43...37 + CEP7-EE

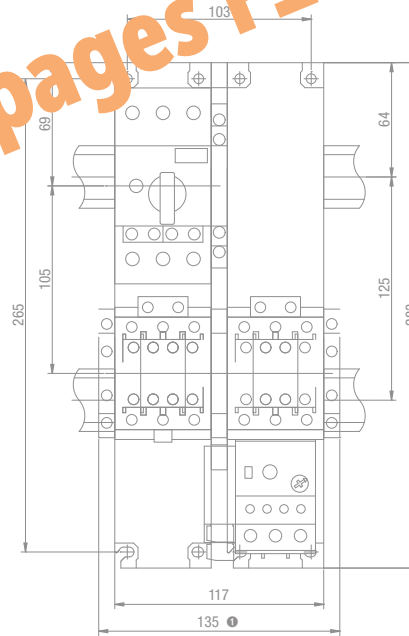

Section Obsolete
See pages F1.40 - F1.55

Dimensions are in millimeters (inches). Dimensions not intended for manufacturing purposes.

- ① With additional side mount auxiliary contact(s)
- ② Dimensions shown apply to AC coil contactors, or 12V or 24V Electronic DC coil contactors. Add 24 mm (1-25/32") to accommodate back pack on 36V...250V Electronic DC coils. See page A86 for details.

Notes

**Section Obsolete
See pages F1.40 - F1.55**

F

ECombo Circuit Controllers

Enclosed Motor Controllers and Molded Case Circuit Breakers



KTA7 Type-E Self Protected Manual Motor Controllers Page F89



Explosion-Proof Motor Controllers

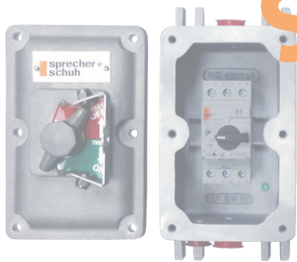

KTA7_EX Page F93

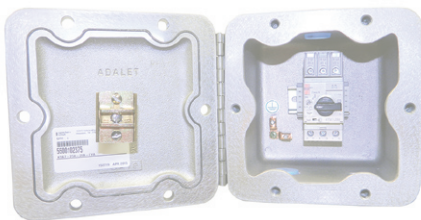

KTA7_EZ Page F94

The following pages contain a selection of single enclosed KTA7 & KTC7 motor controllers which can be applied as an individual Manual Self-Protected Combination Motor Controller or as an individual Manual Motor Starter dependent on the ratings of the individual unit.

- A Self-protected Combination Motor Controller (UL508 Construction Type E) performs all the functions of a Manual Combo starter including a UL approved means "Disconnect" with lockable and defeatable handle mechanism, short-circuit protection and overload protection for motor applications.
- A UL508 Manual Motor Controller is a manual motor starter including a motor disconnect combined with an overload relay.

Both can be combined with auxiliary contacts, shunt-trip or under-voltage trip units to meet your application requirements. The section that follows lists non-metallic enclosures, metal enclosures and explosion proof enclosures.

Enclosed Molded Case Circuit Breakers

The following pages contain a selection of individual enclosed KTU7 molded case circuit breakers for the protection of non-motor loads. KTU7 is a 480Y/277Volt or 600Y/347 volt UL489 approved circuit breaker and the selection of enclosures or combined with matching environmentally approved thru-the-door handle disconnect mechanism which also complies with UL489 standards. KTU7 offers at least 65 KAIC withstand ratings which exceeds those offered by many 600 Volt Class Molded Case Circuit Breakers which



KTU7 Molded Case Circuit Breakers Page F95

are larger and more expensive. Enclosed KTU7 can be combined with auxiliary contacts, shunt-trip or under-voltage trip units to meet your application requirements.

Enclosed Type E/F Combination Starters

KTA7 or KTC7 can be applied in combination with a CA7 contactor for remote control and an enclosure with matching environmentally approved thru-the-door handle disconnect mechanism to meet all requirements for a Construction Type E or F Combination Starter. The following pages contain a selection of individual Combo starters which are smaller and less expensive than Classic Construction Type A (if usable), or Type B (Thermal-magnetic) Molded Case Circuit Breakers offered in Section C of this catalog. The following types are offered:



CX7 Ecombo KWIKStarters Page F98

- Non-metallic enclosed Combo KwikStarter CX7 and CXU7 with AC or DC coils available as factory assembled or in kit form for field assembly
- Metallic enclosed Combo CX7 and CXU7 with AC or DC coils
- Explosion-proof enclosed CX7 and CXU7 with AC or DC coils

A variety of modifications are available.



CX7 Combination Controllers Page F105

Section Obsolete - F1.88
See pages F1.56 - F1.88

Enclosed KTA7 - IP65

Amp / Horsepower Rating						Non-metallic (IP65) Enclosure		Dimension Code	
Max. Horsepower 123						O/L Relay Ampere Range	Magnetic Res. Current		Catalog Number 4
Single Phase		Three Phase							
115V	230V	200V	230V	460V	575V				
KTA7-25S/32S Standard Interrupting Capacity									
~	~	~	~	~	~	0.10...0.16	2.1	KTA7-25S-0.16A-CG	AY
~	~	~	~	~	~	0.16...0.25	3.3	KTA7-25S-0.25A-CG	AY
~	~	~	~	~	1/4	0.25...0.40	5.2	KTA7-25S-0.4A-CG	AY
~	~	~	~	1/4	1/3	0.40...0.63	8.2	KTA7-25S-0.63A-CG	AY
~	~	~	~	1/2	3/4	0.63...1.0	13	KTA7-25S-1A-CG	AY
~	1/10	1/4	1/3	1	1	1.0...1.6	21	KTA7-25S-1.6A-CG	AY
1/10	1/6	1/2	3/4	1-1/2	2	1.6...2.5	33	KTA7-25S-2.5A-CG	AY
1/8	1/3	1	1	3	3	2.5...4	52	KTA7-25S-4A-CG	AY
1/4	3/4	1-1/2	2	5	5	4...6.3	82	KTA7-25S-6.3A-CG	AY
1/2	1-1/2	3	3	7-1/2	10	6.3...10	130	KTA7-25S-10A-CG	AY
1	3	5	5	15	15	10...16	208	KTA7-25S-16A-CG	AY
1-1/2	3	5	7-1/2	15	20	14.5...20	260	KTA7-25S-20A-CG	AY
2	3	7-1/2	7-1/2	20	20	18...25	375	KTA7-25S-25A-CG	AY
2	5	7-1/2	10	20	25	23...25	409	KTA7-32S-29A-CG	AY
3	5	7-1/2	10	25	30	27...32	448	KTA7-32S-32A-CG	AY



Includes:

- Non-metallic (IP65) enclosure with integrated IP65 operator – watertight, dusttight
- KT7-25S/32S (Standard Interrupting Capacity) “Type E” Self-protected Combination Manual Controller 5
- Terminal Adaptor for Type E Applications (Cat.# KT7-25-TE1)
- Gray and black IP65 handle 4 5

Enclosure Only

Description	Catalog Number
Gray/Black handle	KT7-AYTG2
Red/Yellow handle	KT7-AYTJ2
Accessory	
Ground (PE) Terminal	KS7-AYMTN

Modifications (Factory Assembled)

Description	Add Suffix to Cat. Number
KT7 Auxiliary Trip Contacts, Front Mount 300V max.	
1 NO Auxiliary	-A10
1 NC Auxiliary	-A01
1 NO + 1 NC Auxiliary	-A11
2 NO Auxiliaries	-A20
1 NO SC+OL + 1 NC Auxiliary	-T10A01
1 NO SC+OL + 1 NO Auxiliary	-T10A10
Side Mount 600V max.	
2 NC Auxiliaries	-AS02
2 NO Auxiliaries	-AS20
1 NO + 1 NC Auxiliary	-AS11
Additional KT7 Trip Contacts, Side Mount 600V max.	
1 NO SC+OL+1 NO SC	-R00
1 NO SC+OL+1 NC SC	-R01
1 NC SC+OL+1 NO SC	-R10
Accessories	
Undervoltage Release Module	-UA-*
Shunt Release Module	-AA-*

Section Obsolete
See pages F1.56 - F1.68

- Horsepower ratings shown in the table above are for reference. The final selection of the controller depends on the actual motor full load current and service factor.
 - For motor with service factor less than 1.15. Use motor nameplate full load current times 0.9 and choose the motor starter with the appropriate current range. Example: Motor FLC = 4.2A; S.F. = 1.0. 4.2A x 0.9 = 3.78A. Select catalog number KTA7-25S-4A.
- Magnetic trip is fixed at 13x the maximum value of the current adjustment range. Refer to page F5 for applied KAIC ratings.
- KTA7 may be applied to single phase loads if 3 poles of device are wired in series. See footnote 1 for device selection criteria.
- A red and yellow handle may be selected instead of the standard gray and black handle. Change “CG” suffix to “CJ”. Ex: Change KTA7-25S-0.16-CG to KTA7-25S-0.16-CJ.
- Handles are built-in to the enclosure and are not available as components.
- Catalog numbers with specific voltages (i.e. @ 575V) shaded in gray are suitable for use as a manual motor starter only because they are not Type E rated. See page F5 for ratings.

-UA..-AA Coil Codes (*)

AC Coil Code	Voltage Range	
	50 Hz	60 Hz
24V	21V	24V
28V	24V	28V
120V	105V	120V
127V	110V	127V
230V	220...230V	~
240V	~	240...260V
277V	240V	277V
460V	380...400V	400...460V
480V	415V	480V
600V	550V	600V

Enclosed KTA7 - Type 4 / 4X / 12

Amp / Horsepower Rating						Non-metallic, Type 4 / 4X / 12 Enclosure	

Includes:

- Type 4 / 4X / 12 enclosure – watertight, dusttight, corrosion resistant
- KTA7 “Type E” Self-protected Combination Manual Controller (Standard Interrupting Capacity) ⑤
- Terminal Adaptor for Type E Applications (Cat.# KT7-25-TE1 or KT7-45-TE)
- Gray and black Type 4/4X/12; IP66 handle (Cat.# KT7-HTN) ④

Modifications (Factory Assembled)

Description	Add Suffix to Cat. Number
KT7 Auxiliaries & Trip Contacts, Front Mount 300V max.	
1 NO Auxiliary	-A10
1 NC Auxiliary	-A01
1 NO + 1 NC Auxiliary	-A11
2 NO Auxiliaries	-A20
1 NO SC + OL + 1 NC	-T10A01
1 NC SC + OL + 1 NO	-T10A10
Side Mount 600V max.	
2 NC Auxiliaries	-AS02
2 NO Auxiliaries	-AS20
1 NO + 1 NC Auxiliary	-AS11
Additional KT7 Trip Contacts, Side Mount 600V max.	
1 NO SC + OL + 1 NO SC	-R00
1 NO SC + OL + 1 NC SC	-R01
1 NC SC + OL + 1 NO SC	-R10
Accessories	
Undervoltage Release Module	-UA-*
Shunt Release Module	-AA-*

-UA..-AA Coil Codes (*)

AC Coil Code	Voltage Range	
	50 Hz	60 Hz
24V	21V	24V
28V	24V	28V
120V	105V	120V
127V	110V	127V
230V	220...230V	~
240V	~	240...260V
277V	240V	277V
460V	380...400V	400...460V
480V	415V	480V
600V	550V	600V

Max. Horsepower ①②③						O/L Relay Ampere Range	Magnetic Res. Current	Catalog Number ④	Dimension Code
Single Phase		Three Phase							
115V	230V	200V	230V	460V	575V				
KTA7-25S/32S Standard Interrupting Capacity									
~	~	~	~	~	~	0.10...0.16	2.1	KTA7-25S-0.16A-VG	Q5
~	~	~	~	~	~	0.16...0.25	3.3	KTA7-25S-0.25A-VG	Q5
~	~	~	~	~	1/4	0.25...0.40	5.2	KTA7-25S-0.4A-VG	Q5
~	~	~	~	1/4	1/3	0.40...0.63	8.2	KTA7-25S-0.63A-VG	Q5
~	~	~	~	1/2	3/4	0.63...1.0	13	KTA7-25S-1A-VG	Q5
~	1/10	1/4	1/3	1	1	1.0...1.6	21	KTA7-25S-1.6A-VG	Q5
1/10	1/6	1/2	3/4	1-1/2	2	1.6...2.5	33	KTA7-25S-2.5A-VG	Q5
1/8	1/3	1	1	3	3	2.5...4	52	KTA7-25S-4A-VG	Q5
1/4	3/4	1-1/2	2	5	5	4...6.3	82	KTA7-25S-6.3A-VG	Q5
1/2	1-1/2	3	3	7-1/2	10	6.3...10	130	KTA7-25S-10A-VG	Q5
1	3	5	5	10	15	10...16	208	KTA7-25S-16A-VG	Q5
1-1/2	3	5	7-1/2	15	20	14.5...20	260	KTA7-25S-20A-VG	Q5
2	3	7-1/2	7-1/2	20	20	18...25	325	KTA7-25S-25A-VG	Q5
2	5	7-1/2	10	20	25	24...29	406	KTA7-32S-29A-VG	Q5
3	5	7-1/2	10	25	30	27...32	448	KTA7-32S-32A-VG	Q5
KTA7-25H/32H High Interrupting Capacity									
1/10	1/6	1/2	3/4	1-1/2	2	1.6...2.5	33	KTA7-25H-2.5A-VG	Q6
1/8	1/3	1	1	3	3	2.5...4	52	KTA7-25H-4A-VG	Q6
1/4	1/2	1-1/2	2	5	5	4...6.3	82	KTA7-25H-6.3A-VG	Q6
1/2	1-1/2	3	3	7-1/2	10	6.3...10	130	KTA7-25H-10A-VG	Q6
1	3	5	5	10	15	10...16	208	KTA7-25H-16A-VG	Q6
1-1/2	3	5	7-1/2	15	20	14.5...20	260	KTA7-25H-20A-VG	Q6
2	3	7-1/2	7-1/2	20	20	18...25	325	KTA7-25H-25A-VG	Q6
2	5	7-1/2	10	20	25	24...29	406	KTA7-32H-29A-VG	Q6
3	5	7-1/2	10	25	30	27...32	448	KTA7-32H-32A-VG	Q6
KTA7-45H High Interrupting Capacity									
1/2	1-1/2	3	3	7-1/2	7-1/2	6.3...10	130	KTA7-45H-10A-VG	Q7
1	3	5	5	10	10	10...16	208	KTA7-45H-16A-VG	Q7
1-1/2	3	5	7-1/2	15	15	14.5...20	260	KTA7-45H-20A-VG	Q7
2	3	~	10	20	20	18...25	325	KTA7-45H-25A-VG	Q7
3	5	7-1/2	10	25	30	23...32	416	KTA7-45H-32A-VG	Q7
3	7-1/2	10	15	30	40	32...45	585	KTA7-45H-45A-VG	Q7

- ① Horsepower ratings shown in the table above are for reference. The final selection of the controller depends on the actual motor full load current and service factor.
 - For motor with service factor less than 1.15. Use motor nameplate full load current times 0.9 and choose the motor starter with the appropriate current range. Example: Motor FLC = 4.2A; S.F. = 1.0. 4.2A x 0.9 = 3.78A. Select catalog number KTA7-25S-4A.
- ② Magnetic trip is fixed at 13x the maximum value of the current adjustment range. Refer to page F5 for applied KAIC ratings.

- ③ KTA7 may be applied to single phase loads if 3 poles of device are wired in series. See footnote 1 for device selection criteria.
- ④ A red and yellow handle may be selected instead of the standard gray and black handle. Change “VG” suffix to “VJ”. Ex: Change KTA7-25S-0.16-VG to KTA7-25S-0.16-VJ.
- ⑤ Catalog numbers with specific voltages (i.e. @ 575V) shaded in gray are suitable for use as a manual motor starter only because they are not Type E rated. See page F5 for ratings.

Enclosed Motor Circuit Controllers

Section Obsolete
See pages F1.56 - F1.88

Enclosed KTA7 - Type 12

Amp / Horsepower Rating							Painted Steel, Type 12 Enclosure		Dimension Code
Max. Horsepower ①②③						O/L Relay Ampere Range	Magnetic Res. Current	Catalog Number ④	
Single Phase		Three Phase							
115V	230V	200V	230V	460V	575V				
KTA7-25S/32S Standard Interrupting Capacity									
~	~	~	~	~	~	0.10...0.16	2.1	KTA7-25S-0.16A-DG	L
~	~	~	~	~	~	0.16...0.25	3.3	KTA7-25S-0.25A-DG	L
~	~	~	~	~	1/4	0.25...0.40	5.2	KTA7-25S-0.4A-DG	L
~	~	~	~	1/4	1/3	0.40...0.63	8.2	KTA7-25S-0.63A-DG	L
~	~	~	~	1/2	3/4	0.63...1.0	13	KTA7-25S-1A-DG	L
~	1/10	1/4	1/3	1	1	1.0...1.6	21	KTA7-25S-1.6A-DG	L
1/10	1/6	1/2	3/4	1-1/2	2	1.6...2.5	33	KTA7-25S-2.5A-DG	L
1/8	1/3	1	1	3	3	2.5...4	52	KTA7-25S-4A-DG	L
1/4	3/4	1-1/2	2	5	5 [ⓐ]	4...6.3	82	KTA7-25H-6.3A-DG	L
1/2	1-1/2	3	3	7-1/2	10 [ⓐ]	6.3...10	130	KTA7-25H-10A-DG	L
1	3	5	5	10	15	10...16	208	KTA7-25H-16A-DG	L
1-1/2	3	5	7-1/2	15	20 [ⓐ]	14.5...20	260	KTA7-25H-20A-DG	L
2	3	7-1/2 [ⓐ]	7-1/2 [ⓐ]	20 [ⓐ]	20 [ⓐ]	18...25	325	KTA7-25H-25A-DG ⑤	L
2	5	7-1/2 [ⓐ]	10 [ⓐ]	20 [ⓐ]	25 [ⓐ]	24...29	406	KTA7-32S-29A-DG ⑤	L
3	5	7-1/2 [ⓐ]	10 [ⓐ]	25 [ⓐ]	30 [ⓐ]	27...32	448	KTA7-32S-32A-DG ⑤	L
KTA7-25H/32H High Interrupting Capacity									
1/10	1/6	1/2	3/4	1-1/2	2	1.6...2.5	33	KTA7-25H-2.5A-DG	L
1/8	1/3	1	1	3	3	2.5...4	52	KTA7-25H-4A-DG	L
1/4	1/2	1-1/2	2	5	5	4...6.3	82	KTA7-25H-6.3A-DG	L
1/2	1-1/2	3	3	7-1/2	10	6.3...10	130	KTA7-25H-10A-DG	L
1	3	5	5	10	15	10...16	208	KTA7-25H-16A-DG	L
1-1/2	3	5	7-1/2	15	20 [ⓐ]	14.5...20	260	KTA7-25H-20A-DG	L
2	3	7-1/2	7-1/2	20	20 [ⓐ]	18...25	325	KTA7-25H-25A-DG	L
2	5	7-1/2 [ⓐ]	10 [ⓐ]	20 [ⓐ]	25 [ⓐ]	24...29	406	KTA7-32H-29A-DG ⑤	L
3	5	7-1/2 [ⓐ]	10 [ⓐ]	25 [ⓐ]	30 [ⓐ]	27...32	448	KTA7-32H-32A-DG ⑤	L



Includes:

- Type 12 enclosure – dusttight
- KT7-25S/32S (Standard Interrupting Capacity) “Type E” Self-protected Combination Manual Controller ⑤
- Terminal Adaptor for Type E Applications (Cat.# KT7-25-TE1)
- Gray and black Type 4/4X/12; IP66 handle (Cat.# KT7-HTN) ④

Modifications (Factory Assembled)

Description	Add Suffix to Cat. Number
KT7 Auxiliaries & Trip Contacts, Front Mount 300V max.	
1 NO Auxiliary	-A10
1 NC Auxiliary	-A01
1 NO + 1 NC Auxiliary	-A11
2 NO Auxiliaries	-A20
1 NO SC+OL + 1 NC	-T10A01
1 NO SC+OL + 1 NO	-T10A10
Side Mount 600V max.	
2 NC Auxiliaries	-AS02
2 NO Auxiliaries	-AS20
1 NO SC+OL Auxiliary	-AS11
Additional KT7 Trip Contacts, Side Mount 600V max.	
1 NO SC+OL+1 NO SC	-R00
1 NO SC+OL+1 NC SC	-R01
1 NC SC+OL+1 NO SC	-R10
Accessories	
Undervoltage Release Module	-UA-*
Shunt Release Module	-AA-*

-UA..-AA Coil Codes (*)

AC Coil Code	Voltage Range	
	50 Hz	60 Hz
24V	21V	24V
28V	24V	28V
120V	105V	120V
127V	110V	127V
230V	220...230V	~
240V	~	240...260V
277V	240V	277V
460V	380...400V	400...460V
480V	415V	480V
600V	550V	600V

- ① Horsepower ratings shown in the table above are for reference. The final selection of the controller depends on the actual motor full load current and service factor.
 - For motor with service factor less than 1.15. Use motor nameplate full load current times 0.9 and choose the motor starter with the appropriate current range. Example: Motor FLC = 4.2A; S.F. = 1.0. 4.2A x 0.9 = 3.78A. Select catalog number KTA7-25S-4A.
- ② Magnetic trip is fixed at 13x the maximum value of the current adjustment range. Refer to page F5 for applied KAIC ratings.

- ③ KTA7 may be applied to single phase loads if 3 poles of device are wired in series. See footnote 1 for device selection criteria.
- ④ A red and yellow handle may be selected instead of the standard gray and black handle. Change “DG” suffix to “DJ”. Ex: Change KTA7-25S-0.16-DG to KTA7-25S-0.16-DJ.
- ⑤ Catalog numbers with specific voltages (i.e. @ 575V) shaded in gray are suitable for use as a manual motor starter only because they are not Type E rated. See page F5 for ratings.

Section Obsolete
See pages F1.56 - F1.88

Enclosed KTA7 - Type 4 / 12

Amp / Horsepower Rating							Painted Steel, Type 4 / 12 Enclosure		Dimension Code
Max. Horsepower ①②③						O/L Relay Ampere Range	Magnetic Res. Current	Catalog Number ④	
Single Phase		Three Phase							
115V	230V	200V	230V	460V	575V				
KTA7-25S/32S Standard Interrupting Capacity									
~	~	~	~	~	~	0.10...0.16	2.1	KTA7-25S-0.16A-WG	W6
~	~	~	~	~	~	0.16...0.25	3.3	KTA7-25S-0.25A-WG	W6
~	~	~	~	~	1/4	0.25...0.40	5.2	KTA7-25S-0.4A-WG	W6
~	~	~	~	1/4	1/3	0.40...0.63	8.2	KTA7-25S-0.63A-WG	W6
~	~	~	~	1/2	3/4	0.63...1.0	13	KTA7-25S-1A-WG	W6
~	1/10	1/4	1/3	1	1	1.0...1.6	21	KTA7-25S-1.6A-WG	W6
1/10	1/6	1/2	3/4	1-1/2	2	1.6...2.5	33	KTA7-25S-2.5A-WG	W6
1/8	1/3	1	1	3	3	2.5...4	52	KTA7-25S-4A-WG	W6
1/4	3/4	1-1/2	2	5	5	4...6.3	82	KTA7-25S-6.3A-WG	W6
1/2	1-1/2	3	3	7-1/2	10	6.3...10	130	KTA7-25S-10A-WG	W6
1	3	5	5	10	15	10...16	208	KTA7-25S-16A-WG	W6
1-1/2	3	5	7-1/2	15	20	14.5...20	260	KTA7-25S-20A-WG	W6
2	3	7-1/2	7-1/2	20	20	18...25	325	KTA7-25S-25A-WG	W6
2	5	7-1/2	10	20	25	24...29	406	KTA7-32S-29A-WG	W6
3	5	7-1/2	10	25	30	27...32	448	KTA7-32S-32A-WG	W6
KTA7-25H/32H High Interrupting Capacity									
1/10	1/6	1/2	3/4	1-1/2	2	1.6...2.5	33	KTA7-25H-2.5A-WG	W6
1/8	1/3	1	1	3	3	2.5...4	52	KTA7-25H-4A-WG	W6
1/4	1/2	1-1/2	2	5	5	4...6.3	82	KTA7-25H-6.3A-WG	W6
1/2	1-1/2	3	3	7-1/2	10	6.3...10	130	KTA7-25H-10A-WG	W6
1	3	5	5	10	15	10...16	208	KTA7-25H-16A-WG	W6
1-1/2	3	5	7-1/2	15	20	14.5...20	260	KTA7-25H-20A-WG	W6
2	3	7-1/2	7-1/2	20	20	18...25	325	KTA7-25H-25A-WG	W6
2	5	7-1/2	10	20	25	24...29	406	KTA7-32H-29A-WG	W6
3	5	7-1/2	10	25	30	27...32	448	KTA7-32H-32A-WG	W6
KTA7-45H High Interrupting Capacity									
1/2	1-1/2	3	3	7-1/2	7-1/2	6.3...10	130	KTA7-45H-10A-WG	R/F
1	3	5	5	10	10	10...16	208	KTA7-45H-16A-WG	R/F
1-1/2	3	5	7-1/2	15	15	14.5...20	260	KTA7-45H-20A-WG	R/F
2	3	~	10	20	20	18...25	325	KTA7-45H-25A-WG	R/F
3	5	7-1/2	10	25	30	23...32	416	KTA7-45H-32A-WG	R/F
3	7-1/2	10	15	30	40	32...45	585	KTA7-45H-45A-WG	R/F

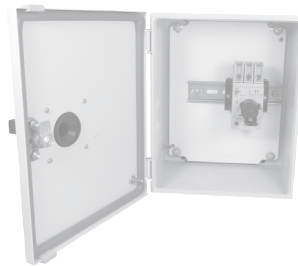

Includes:

- Type 4 / 12 enclosure – watertight, dusttight
- KT7-25S/32S (Standard Interrupting Capacity) “Type E” Self-protected Combination Manual Controller ⑤
- Terminal Adaptor for Type E Applications (Cat.# KT7-25-TE1 or KT7-45-TE)
- Gray and black Type 4/4X/12; IP66 handle (Cat.# KT7-HTN) ④

Modifications (Factory Assembled)

Description	Add Suffix to Cat. Number
KT7 Auxiliaries & Trip Contacts, Front Mount 300V max.	
1 NO Auxiliary	-A10
1 NC Auxiliary	-A01
1 NO + 1 NC Auxiliary	-A11
2 NO Auxiliaries	-A20
1 NO SC+OL + 1 NC	-T10A01
1 NO SC+OL + 1 NO	-T10A10
KT7 Auxiliaries & Trip Contacts, Side Mount 600V max.	
2 NC Auxiliaries	-AS02
2 NO Auxiliaries	-AS20
1 NO + 1 NC Auxiliary	-AS11
Additional Trip Contacts, Side Mount 600V max.	
1 NO SC+OL+1 NO SC	-R00
1 NO SC+OL+1 NC SC	-R01
1 NC SC+OL+1 NO SC	-R10
Accessories	
Undervoltage Release Module	-UA-*
Shunt Release Module	-AA-*

-UA..-AA Coil Codes (*)

AC Coil Code	Voltage Range	
	50 Hz	60 Hz
24V	21V	24V
28V	24V	28V
120V	105V	120V
127V	110V	127V
230V	220...230V	~
240V	~	240...260V
277V	240V	277V
460V	380...400V	400...460V
480V	415V	480V
600V	550V	600V

① Horsepower ratings shown in the table above are for reference. The final selection of the controller depends on the actual motor full load current and service factor.

- For motor with service factor less than 1.15. Use motor nameplate full load current times 0.9 and choose the motor starter with the appropriate current range. Example: Motor FLC = 4.2A; S.F. = 1.0. 4.2A x 0.9 = 3.78A. Select catalog number KTA7-25S-4A.

② Magnetic trip is fixed at 13x the maximum value of the current adjustment range. Refer to page F5 for applied KAIC ratings.

③ KTA7 may be applied to single phase loads if 3 poles of device are wired in series. See footnote 1 for device selection criteria.

④ A red and yellow handle may be selected instead of the standard gray and black handle. Change “WG” suffix to “WJ”. Ex: Change KTA7-25S-0.16-WG to KTA7-25S-0.16-WJ.

⑤ Catalog numbers with specific voltages (i.e. @ 575V) shaded in gray are suitable for use as a manual motor starter only because they are not Type E rated. See page F5 for ratings.

Enclosed Motor Circuit Controllers

Section Obsolete
See pages F1.56 - F1.88

KTA7 Explosion Proof Motor Controllers - NEMA Type 7/9

Amp / Horsepower Rating							O/L Relay Ampere Range		Magnetic Res. Current	Catalog Number	Dimension Code
Max. Horsepower ①②③							Interrupting Capacity				
Single Phase		Three Phase									
115V	230V	200V	230V	460V	575V						
~	~	~	~	~	~	0.10...0.16	2.1	KTA7-25S-0.16A-EX	EX		
~	~	~	~	~	~	0.16...0.25	3.3	KTA7-25S-0.25A-EX	EX		
~	~	~	~	~	1/4	0.25...0.40	5.2	KTA7-25S-0.4A-EX	EX		
~	~	~	~	1/4	1/3	0.40...0.63	8.2	KTA7-25S-0.63A-EX	EX		
~	~	~	~	1/2	3/4	0.63...1.0	13	KTA7-25S-1A-EX	EX		
~	1/10	1/4	1/3	1	1	1.0...1.6	21	KTA7-25S-1.6A-EX	EX		
1/10	1/6	1/2	3/4	1-1/2	2	1.6...2.5	33	KTA7-25S-2.5A-EX	EX		
1/8	1/3	1	1	3	3	2.5...4	52	KTA7-25S-4A-EX	EX		
1/4	3/4	1-1/2	2	5	5	4...6.3	82	KTA7-25S-6.3A-EX	EX		
1/2	1-1/2	3	3	7-1/2	10	6.3...10	110	KTA7-25S-10A-EX	EX		
1	3	5	5	10	15	10...16	160	KTA7-25S-16A-EX	EX		
1-1/2	3	5	7-1/2	10	15	14...20	260	KTA7-25S-20A-EX	EX		
2	3	7-1/2	7-1/2	20	25	18...25	325	KTA7-25S-25A-EX	EX		
2	5	7-1/2	10	20	25	24...29	440	KTA7-32S-29A-EX	EX		
3	5	7-1/2	10	25	30	28...35	440	KTA7-32S-32A-EX	EX		

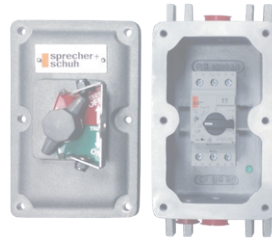

Includes:

- Class I, Div 1, 2, Group C, D
Class II, Div 1, 2, Group E, F & G enclosure
Class III
NEMA Type 7/9
- KT7-25S/32S (Standard interrupting capacity) "Type E" Self-protected Combination Manual Motor Controller ④
- Terminal Adaptor for Type E Applications (Cat.# KT7-25-TE1)

Modifications (Factory Assembled) ⑤

KT7 Auxiliaries & Trip Contacts	Add Suffix to Cat. Number
Front Mount 300V max.	
1 NO Auxiliary	-A10
1 NC Auxiliary	-A01
1 NO + 1 NC Auxiliary	-A11
2 NO Auxiliaries	-A20
1 NO SC+OL + 1 NC Auxiliary	-T10A01
1 NO SC+OL + 1 NO Auxiliary	-T10A10
Side Mount 300V max.	
1 NO + 1 NC Auxiliary	-AS11
2 NO Auxiliaries	-AS20
1 NC SC+OL + 1 NO Auxiliary	-R10
1 NC SC+OL + 1 NC Auxiliary	-R11
Enclosure Modifications	
Breather/Drain	-BD

Section Obsolete FL 56 - FL 88
See pages FL 56 - FL 88

① Horsepower ratings shown in the table above are for reference. The final selection of the controller depends on the actual motor full load current and service factor.

- For motor with service factor less than 1.15. Use motor nameplate full load current times 0.9 and choose the motor starter with the appropriate current range. Example: Motor FLC = 4.2A; S.F. = 1.0. 4.2A x 0.9 = 3.78A. Select catalog number KTA7-25S-4A.

② Magnetic trip is fixed at 13x the maximum value of the current adjustment range. Refer to page F5 for applied KAIC ratings.

③ KTA7 may be applied to single phase loads if 3 poles of device are wired in series. See footnote 1 for device selection criteria.

④ Catalog numbers with specific voltages (i.e. @ 575V) shaded in gray are suitable for use as a manual motor starter only because they are not Type E rated. See page F5 for ratings.

⑤ -UA* and -AA* options not possible in the -EX Enclosure.

KTA7 Explosion Proof Motor Controllers – NEMA Type 4/7/9 with Gasket

Amp / Horsepower Rating						O/L Relay Ampere Range		Magnetic Res. Current	Catalog Number	Dimension Code
Max. Horsepower ①②③										
Single Phase		Three Phase								
115V	230V	200V	230V	460V	575V					
KTA7-25S Standard Interrupting Capacity										
~	~	~	~	~	~	0.10...0.16	2.1	KTA7-25S-0.16A-EY	EY	
~	~	~	~	~	~	0.16...0.25	3.3	KTA7-25S-0.25A-EY	EY	
~	~	~	~	~	1/4	0.25...0.40	5.2	KTA7-25S-0.4A-EY	EY	
~	~	~	~	1/4	1/3	0.40...0.63	8.2	KTA7-25S-0.63A-EY	EY	
~	~	~	~	1/2	3/4	0.63...1.0	13	KTA7-25S-1A-EY	EY	
~	1/10	1/4	1/3	1	1	1.0...1.6	21	KTA7-25S-1.6A-EY	EY	
1/10	1/6	1/2	3/4	1-1/2	2	1.6...2.5	33	KTA7-25S-2.5A-EY	EY	
1/8	1/3	1	1	3	3	2.5...4	52	KTA7-25S-4A-EY	EY	
1/4	3/4	1-1/2	2	5	5	4...6.3	82	KTA7-25S-6.3A-EY	EY	
1/2	1-1/2	3	3	7-1/2	10	6.3...10	130	KTA7-25S-10A-EY	EY	
1	3	5	5	10	15	10...16	208	KTA7-25S-16A-EY	EY	
1-1/2	3	5	7-1/2	15	20	14.5...20	260	KTA7-25H-20A-EY	EY	
2	3	7-1/2	7-1/2	20	20	18...25	325	KTA7-25H-25A-EY	EY	
2	5	7-1/2	10	20	25	24...29	406	KTA7-32S-29A-EY	EY	
3	5	7-1/2	10	25	30	27...32	448	KTA7-32S-32A-EY	EY	
KTA7-25H High Interrupting Capacity										
1/10	1/6	1/2	3/4	1-1/2	2	1.0...2.5	33	KTA7-25H-2.5A-EY	EY	
1/8	1/3	1	1	3	3	2.5...4	52	KTA7-25H-4A-EY	EY	
1/4	1/2	1-1/2	2	5	5	4...6.3	82	KTA7-25H-6.3A-EY	EY	
1/2	1-1/2	3	3	7-1/2	10	6.3...10	130	KTA7-25H-10A-EY	EY	
1	3	5	5	10	15	10...16	208	KTA7-25H-16A-EY	EY	
1-1/2	3	5	7-1/2	15	20	14.5...20	260	KTA7-25H-20A-EY	EY	
2	3	7-1/2	7-1/2	20	20	18...25	325	KTA7-25H-25A-EY	EY	
2	5	7-1/2	10	20	25	24...29	406	KTA7-32H-29A-EY	EY	
3	5	7-1/2	10	25	30	27...32	448	KTA7-32H-32A-EY	EY	
KTA7-45H High Interrupting Capacity										
1/2	1-1/2	3	3	7-1/2	7-1/2	6.3...10	130	KTA7-45H-10A-EZ	EZ	
1	3	5	5	10	10	10...16	208	KTA7-45H-16A-EZ	EZ	
1-1/2	3	5	7-1/2	15	15	14.5...20	260	KTA7-45H-20A-EZ	EZ	
2	3	~	10	20	20	18...25	325	KTA7-45H-25A-EZ	EZ	
3	5	7-1/2	10	25	30	23...32	416	KTA7-45H-32A-EZ	EZ	
3	7-1/2	10	15	30	40	32...45	585	KTA7-45H-45A-EZ	EZ	

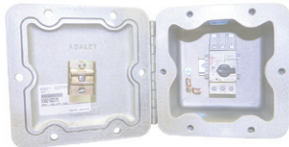

EY Enclosure shown

Includes:

- Class I, Div 1, 2, Group C, D
Class II, Div 1, 2, Group E, F & G enclosure
Class III
- NEMA Type 4/7/9
- KT7 "Type E" Self-protected Combination Manual Motor Controller ④
- Terminal Adaptor for Type E Applications (Cat.# KT7-25-TE1 or KT7-45-TE)

Modifications (Factory Assembled)

Description	Add Suffix to Cat. Number
KT7 Auxiliaries & Trip Contacts, Front Mount 300V max.	
1 NO Auxiliary	-A10
1 NC Auxiliary	-A01
1 NO + 1 NC Auxiliary	-A11
2 NO Auxiliaries	-A20
1 NO SC+OL + 1 NO SC	-T10A01
1 NO SC+OL + 1 NC SC	-T10A10
Side Mount 600V max.	
2 NO Auxiliaries	-AS02
2 NO Auxiliaries	-AS20
1 NO + 1 NC Auxiliary	-AS11
Additional KT7 Trip Contacts, Side Mount 600V max.	
1 NO SC+OL+1 NO SC	-R00
1 NO SC+OL+1 NC SC	-R01
1 NC SC+OL+1 NO SC	-R10
Accessories	
Undervoltage Release Module	-UA-*
Shunt Release Module	-AA-*
Enclosure Modifications	
Breather/Drain	-BD

-UA..-AA Coil Codes (*)

AC Coil Code	Voltage Range	
	50 Hz	60 Hz
24V	21V	24V
28V	24V	28V
120V	105V	120V
127V	110V	127V
230V	220...230V	~
240V	~	240...260V
277V	240V	277V
460V	380...400V	400...460V
480V	415V	480V

- ① Horsepower ratings shown in the table above are for reference. The final selection of the controller depends on the actual motor full load current and service factor.
 - For motor with service factor less than 1.15. Use motor nameplate full load current times 0.9 and choose the motor starter with the appropriate current range. Example: Motor FLC = 4.2A; S.F. = 1.0. 4.2A x 0.9 = 3.78A. Select catalog number KTA7-25S-4A.
- ② Magnetic trip is fixed at 13x the maximum value of the current adjustment range. See page F5 for KAIC ratings.
- ③ KTA7 may be applied to single phase loads if 3 poles of device are wired in series. See footnote ① for device selection criteria.
- ④ Catalog numbers with specific voltages (i.e. @ 575V) shaded in gray are suitable for use as a manual motor starter only because they are not Type E rated. See page F5 for ratings.

F Enclosed Motor Circuit Controllers

Section Obsolete - F1.88
See pages F1.56 - F1.88

Enclosed KTU7 Circuit Breaker - Type 4 / 4X / 12

Amp / Interrupt Rating		Non-metallic, Type 4 / 4X / 12 Enclosure				Dimension Code
Fixed Thermal Current Rating [A]	Magnetic Trip [A]	Interrupting Rating (60Hz) [KA]			Catalog Number	
		240V	480Y /277V	600Y /347V		
KTU7-D — High Interrupting Capacity — 2-Pole						
0.5	15...20xIn	100	100	50	KTU7-D-2D-0.5-VG	Q6 ①
1.0	15...20xIn	100	100	50	KTU7-D-2D-1-VG	
2.0	15...20xIn	100	100	50	KTU7-D-2D-2-VG	
3.0	15...20xIn	100	100	50	KTU7-D-2D-3-VG	
4.0	15...20xIn	100	100	50	KTU7-D-2D-4-VG	
5.0	15...20xIn	100	100	50	KTU7-D-2D-5-VG	
6.0	15...20xIn	100	100	50	KTU7-D-2D-6-VG	
8.0	15...20xIn	100	100	50	KTU7-D-2D-8-VG	
10.0	15...20xIn	100	100	50	KTU7-D-2D-10-VG	
12.0	15...20xIn	65	65	25	KTU7-D-2D-12-VG	
15.0	15...20xIn	65	65	25	KTU7-D-2D-15-VG	
20.0	15...20xIn	65	65	25	KTU7-D-2D-20-VG	
25.0	15...20xIn	65	65	25	KTU7-D-2D-25-VG	
30.0	15...20xIn	65	65	25	KTU7-D-2D-30-VG	
KTU7-D — High Interrupting Capacity — 3-Pole						
0.5	15...20xIn	100	100	50	KTU7-D-3D-0.5-VG	Q6 ①
1.0	15...20xIn	100	100	50	KTU7-D-3D-1-VG	
2.0	15...20xIn	100	100	50	KTU7-D-3D-2-VG	
3.0	15...20xIn	100	100	50	KTU7-D-3D-3-VG	
4.0	15...20xIn	100	100	50	KTU7-D-3D-4-VG	
5.0	15...20xIn	100	100	50	KTU7-D-3D-5-VG	
6.0	15...20xIn	100	100	50	KTU7-D-3D-6-VG	
8.0	15...20xIn	100	100	50	KTU7-D-3D-8-VG	
10.0	15...20xIn	100	100	50	KTU7-D-3D-10-VG	
12.0	15...20xIn	65	65	25	KTU7-D-3D-12-VG	
15.0	15...20xIn	65	65	25	KTU7-D-3D-15-VG	
20.0	15...20xIn	65	65	25	KTU7-D-3D-20-VG	
25.0	15...20xIn	65	65	25	KTU7-D-3D-25-VG	
30.0	15...20xIn	65	65	25	KTU7-D-3D-30-VG	



Includes:

- Type 4 / 4X / 12 enclosure – watertight, dusttight, corrosion resistant
- KTU7 UL489 Molded Case Circuit Breaker
- Black Type 4/4X/12; IP66 handle (Cat.# KT7-HTN Series E) ②

Modifications (Factory Assembled) ③

KTU7 Auxiliaries & Trip Contacts - Front Mount 300V max.	Add Suffix to Cat. Number
1 NO Auxiliary	-A10
1 NC Auxiliary	-A01
1 NO + 1 NC Auxiliary	-A11
2 NO Auxiliaries	-A20
1 NO SC+OL + 1 NC Auxiliary	-T10A01
1 NO SC+OL + 1 NO Auxiliary	-T10A10

Section Obsolete
See pages F1.56 - F1.88

① KTU7 is 80% rated in this enclosure.
 ② A red and yellow handle may be selected instead of the standard black handle. Change "VG" suffix to "VJ". Ex: Change KTU7-D-2D-0.16-VG to KTU7-D-2D-0.16-VJ.
 ③ Load Terminal Cover KT7-PEFC is included with any factory modifications.

Enclosed KTU7 Circuit Breaker - Type 12

Amp / Interrupt Rating		Painted Steel, Type 12 Enclosure			Catalog Number	Dimension Code
Fixed Thermal Current Rating [A]	Magnetic Trip [A]	Interrupting Rating (60Hz) [KA]				
		240V	480Y /277V	600Y /347V		
KTU7-D — High Interrupting Capacity – 2-Pole						
0.5	15...20xIn	100	100	50	KTU7-D-2D-0.5-DG	L
1.0	15...20xIn	100	100	50	KTU7-D-2D-1-DG	
2.0	15...20xIn	100	100	50	KTU7-D-2D-2-DG	
3.0	15...20xIn	100	100	50	KTU7-D-2D-3-DG	
4.0	15...20xIn	100	100	50	KTU7-D-2D-4-DG	
5.0	15...20xIn	100	100	50	KTU7-D-2D-5-DG	
6.0	15...20xIn	100	100	50	KTU7-D-2D-6-DG	
8.0	15...20xIn	100	100	50	KTU7-D-2D-8-DG	
10.0	15...20xIn	100	100	50	KTU7-D-2D-10-DG	
12.0	15...20xIn	65	65	25	KTU7-D-2D-12-DG	
15.0	15...20xIn	65	65	25	KTU7-D-2D-15-DG	
20.0	15...20xIn	65	65	25	KTU7-D-2D-20-DG	
25.0	15...20xIn	65	65	25	KTU7-D-2D-25-DG	
30.0	15...20xIn	65	65	25	KTU7-D-2D-30-DG	
KTU7-D — High Interrupting Capacity – 3-Pole						
0.5	15...20xIn	100	100	50	KTU7-D-3D-0.5-DG	L
1.0	15...20xIn	100	100	50	KTU7-D-3D-1-DG	
2.0	15...20xIn	100	100	50	KTU7-D-3D-2-DG	
3.0	15...20xIn	100	100	50	KTU7-D-3D-3-DG	
4.0	15...20xIn	100	100	50	KTU7-D-3D-4-DG	
5.0	15...20xIn	100	100	50	KTU7-D-3D-5-DG	
6.0	15...20xIn	100	100	50	KTU7-D-3D-6-DG	
8.0	15...20xIn	100	100	50	KTU7-D-3D-8-DG	
10.0	15...20xIn	100	100	50	KTU7-D-3D-10-DG	
12.0	15...20xIn	65	65	25	KTU7-D-3D-12-DG	
15.0	15...20xIn	65	65	25	KTU7-D-3D-15-DG	
20.0	15...20xIn	65	65	25	KTU7-D-3D-20-DG	
25.0	15...20xIn	65	65	25	KTU7-D-3D-25-DG	
30.0	15...20xIn	65	65	25	KTU7-D-3D-30-DG	



Includes:

- Type 12 enclosure – dusttight
- KTU7 UL489 Molded Case Circuit Breaker
- Black Type 4/4X/12; IP66 handle (Cat.# KT7-HTN Series E) ②

Modifications (Factory Assembled) ③

KT7 Auxiliaries & Trip Contacts - Front Mount, 20V max.	Add Suffix to Cat. Number
NO Auxiliary	-A10
1 NC Auxiliary	-A01
1 NO + 1 NC Auxiliary	-A11
2 NO Auxiliaries	-A20
1 NO SC+OL + 1 NC Auxiliary	-T10A01
1 NO SC+OL + 1 NO Auxiliary	-T10A10

Section Obsolete
See pages F1.56 - F1.88

① KTU7 is 80% rated in this enclosure.

② A red and yellow handle may be selected instead of the standard black handle. Change "DG" suffix to "DJ". Ex: Change KTU7-D-2D-0.16-DG to KTU7-D-2D-0.16-DJ.

③ Load Terminal Cover KT7-PEFC is included with any factory modifications.

Enclosed KTU7 Circuit Breaker - Type 4 / 12

Amp / Interrupt Rating		Painted Steel, Type 4 / 12 Enclosure				Dimension Code
Fixed Thermal Current Rating [A]	Magnetic Trip [A]	Interrupting Rating (60Hz) [KA]			Catalog Number	
		240V	480Y /277V	600Y /347V		
KTU7-D — High Interrupting Capacity – 2-Pole						
0.5	15...20xIn	100	100	50	KTU7-D-2D-0.5-WG	W6 ①
1.0	15...20xIn	100	100	50	KTU7-D-2D-1-WG	
2.0	15...20xIn	100	100	50	KTU7-D-2D-2-WG	
3.0	15...20xIn	100	100	50	KTU7-D-2D-3-WG	
4.0	15...20xIn	100	100	50	KTU7-D-2D-4-WG	
5.0	15...20xIn	100	100	50	KTU7-D-2D-5-WG	
6.0	15...20xIn	100	100	50	KTU7-D-2D-6-WG	
8.0	15...20xIn	100	100	50	KTU7-D-2D-8-WG	
10.0	15...20xIn	100	100	50	KTU7-D-2D-10-WG	
12.0	15...20xIn	65	65	25	KTU7-D-2D-12-WG	
15.0	15...20xIn	65	65	25	KTU7-D-2D-15-WG	
20.0	15...20xIn	65	65	25	KTU7-D-2D-20-WG	
25.0	15...20xIn	65	65	25	KTU7-D-2D-25-WG	
30.0	15...20xIn	65	65	25	KTU7-D-2D-30-WG	
KTU7-D — High Interrupting Capacity – 3-Pole						
0.5	15...20xIn	100	100	50	KTU7-D-3D-0.5-WG	W6 ①
1.0	15...20xIn	100	100	50	KTU7-D-3D-1-WG	
2.0	15...20xIn	100	100	50	KTU7-D-3D-2-WG	
3.0	15...20xIn	100	100	50	KTU7-D-3D-3-WG	
4.0	15...20xIn	100	100	50	KTU7-D-3D-4-WG	
5.0	15...20xIn	100	100	50	KTU7-D-3D-5-WG	
6.0	15...20xIn	100	100	50	KTU7-D-3D-6-WG	
8.0	15...20xIn	100	100	50	KTU7-D-3D-8-WG	
10.0	15...20xIn	100	100	50	KTU7-D-3D-10-WG	
12.0	15...20xIn	65	65	25	KTU7-D-3D-12-WG	
15.0	15...20xIn	65	65	25	KTU7-D-3D-15-WG	
20.0	15...20xIn	65	65	25	KTU7-D-3D-20-WG	
25.0	15...20xIn	65	65	25	KTU7-D-3D-25-WG	
30.0	15...20xIn	65	65	25	KTU7-D-3D-30-WG	



Includes:

- Type 4/12 enclosure – watertight, dusttight
- KTU7 UL489 Molded Case Circuit Breaker
- Black Type 4/4X/12; IP66 handle (Cat.# KT7-HTN Series E) ②

Modifications (Factory Assembled) ③

KTU7 Auxiliaries & Trip Contacts - Front Mount 300V max.	Add Suffix to Cat. Number
1 NO Auxiliary	-A10
1 NC Auxiliary	-A01
1 NO + 1 NC Auxiliary	-A11
2 NO Auxiliaries	-A20
1 NO SC+OL + 1 NC Auxiliary	-T10A01
1 NO SC+OL + 1 NO Auxiliary	-T10A10

Section Obsolete
See pages F1.56 - F1.88

① KTU7 up to 15 Amp is 100% rated in this enclosure. KTU7 20...30 Amp is 80% rated.
 ② A red and yellow handle may be selected instead of the standard black handle. Change "WG" suffix to "WJ". Ex: Change KTU7-D-2D-0.16-WG to KTU7-D-2D-0.16-WJ.
 ③ Load Terminal Cover KT7-PEFC is included with any factory modifications.

Enclosed Non-Reversing Combination Controller, AC Operation - Type 1/12K/IP66 ⑥⑦

Amp / Horsepower Rating				Non-Metallic Type 1/12K/IP66 Enclosure (KS7-COC4R)				
Max. Horsepower ①②③				O/L Relay Ampere Range	Magnetic Response Current	Index ⑤	Catalog Number ④⑥⑦⑧	Dimension Code
Three Phase								
200V	230V	460V	575V					
KTA7-25S Standard Interrupting Capacity								
~	~	~	~	0.10...0.16	2.1	1	CX7-9-10-AS0.16A-A10-PG▼	Q4
~	~	~	~	0.16...0.25	3.3	2	CX7-9-10-AS0.25A-A10-PG▼	Q4
~	~	~	~	0.25...0.40	5.2	3	CX7-9-10-AS0.4A-A10-PG▼	Q4
~	~	~	~	0.40...0.63	8.2	4	CX7-9-10-AS0.63A-A10-PG▼	Q4
~	~	1/2	3/4	0.63...1.0	13	5	CX7-9-10-AS1A-A10-PG▼	Q4
~	~	1	1	1.0...1.6	21	6	CX7-9-10-AS1.6A-A10-PG▼	Q4
1/2	3/4	1-1/2	2	1.6...2.5	33	7	CX7-9-10-AS2.5A-A10-PG▼	Q4
1	1	3	3	2.5...4	52	8	CX7-9-10-AS4A-A10-PG▼	Q4
1-1/2	2	5	~	4...6.3	82	9	CX7-9-10-AH6.3A-A10-PG▼	Q4
3	3	7-1/2	~	6.3...10	130	11	CX7-12-10-AS10A-A10-PG▼	Q4
5	5	10	~	10...16	208	12	CX7-16-10-AS16A-A10-PG▼	Q4
5	7-1/2	15	~	14.5...20	260	13	CX7-23-10-AS20A-A10-PG▼	Q4
KTA7-25H High Interrupting Capacity								
1/2	3/4	1-1/2	2	1.6...2.5	33	17	CX7-9-10-AH2.5A-A10-PG▼	Q4
1	1	3	3	2.5...4	52	19	CX7-9-10-AH4A-A10-PG▼	Q4
1-1/2	2	5	5	4...6.3	82	21	CX7-9-10-AH6.3A-A10-PG▼	Q4
3	3	7-1/2	10	6.3...10	130	23	CX7-12-10-AH10A-A10-PG▼	Q4
5	5	10	15	10...16	208	28	CX7-16-10-AH16A-A10-PG▼	Q4
5	7-1/2	15	~	14.5...20	260	31	CX7-23-10-AH20A-A10-PG▼	Q4
5	7-1/2	15	~	18...25	325	33	CX7-23-10-AH25A-A10-PG▼	Q4



Includes:

- Type 1/12K Non-metallic enclosure (KS7-COC4R)
- KTA7 "Type E/F" Self-protected Combination Motor Controller with 1 NO front mount Auxiliary Contact (Cat #: KT7-PE1-10)
- Terminal Adaptor for Type E Applications (Cat.# KT7-25-TE1)
- CA7 contactor (for remote operation), AC coil
- Gray and black Type 1/12K; IP66 handle (KT7-SHB + KT7-KN1) ③
- Power wiring
- Factory installed Pilot device option ⑥

Replace ▼ with option code. See page F103 for factory installed modifications

Contactor

AC Coil Codes (*) ④

AC Coil Code	Voltage Range	
	50 Hz	60 Hz
24Z	24V	24V
120	110V	120V
220W	200-220V	208-240V
415	400-415V	~
480 ⑨	440V	480V
600 ⑨	550V	600V

KWIKstarter coils are wired standard from the factory to terminals "L1" and "L2" (for line voltage control). This means the coil voltage must match the line voltage. When a coil is specified for 120V or less, it will be wired for a separate control source (not wired to L1 and L2).

- ① Horsepower ratings shown in the table above are for reference. The final selection of the controller depends on the actual motor full load current and service factor. For motor with service factor less than 1.15. Use motor nameplate full load current times 0.9 and choose the motor starter with the appropriate current range. Example: Motor FLC = 4.2A; S.F. = 1.0. 4.2A x 0.9 = 3.78A. Select catalog number KTA7-25S-4A.
- ② Magnetic trip is fixed at 13x the maximum value of the current adjustment range.
- ③ CX7 may be applied to single phase loads. Contact factory for these specifications.
- ④ Other voltages available, see Section A in this catalog.
- ⑤ KAIC Assembly Rating Index. See pages F73-F76 for Application Rating Guide.
- ⑥ One Pilot Device option must be selected. Plastic Bezel is standard. Pilot Device options include D7-BX_Base Mounted contact blocks. Pilot Light option must match coil voltage 24V AC or DC, 120V AC or 240V AC only. See Section H for more information.

- ⑦ CPT not possible with KS7-COC4R. Refer to page F118 for wiring diagram and F119 for dimensional information.
- ⑧ A red and yellow handle may be selected instead of the standard gray and black handle. Change "PG" suffix to "PJ". Ex: Change CX7-9-10-AS0.16A-A10-PG▼ to CX7-9-10-AS0.16A-A10-PJ▼.
- ⑨ Catalog number (-A10) includes front-mounted auxiliary KT7-PE1-10 with 300 VAC maximum control circuit matching line voltage, or provided from separate source, used to de-energize contactor coil under fault condition (auxiliary not available for customer use). For control circuits greater than 300 VAC, which is common with line voltage, the auxiliary will not be wired into the control circuit since the contactor coil will be de-energized when KTA7 is tripped due to overload or short circuit; therefore, the KT7-PE1-10 auxiliary is available for customer use.

Enclosed Motor Circuit Controllers

Section Obsolete
See pages F1.56 - F1.88

Enclosed Non-Reversing Combination Controller, Electronic DC Operation - Type 1/12K/IP66 ④⑥⑦

Amp / Horsepower Rating					Non-Metallic Type 1/12K/IP66 Enclosure (KS7-COC4R)				
Max. Horsepower ①②③				O/L Relay Ampere Range	Magnetic Response Current	Index ⑤	Catalog Number ④⑥⑧	Dimension Code	
Three Phase									
200V	230V	460V	575V	KTA7-25S Standard Interrupting Capacity					
~	~	~	~	0.10...0.16	2.1	1	CX7-9E-10- * -AS0.16A-A10-PG▼	Q4	
~	~	~	~	0.16...0.25	3.3	2	CX7-9E-10- * -AS0.25A-A10-PG▼	Q4	
~	~	~	~	0.25...0.40	5.2	3	CX7-9E-10- * -AS0.4A-A10-PG▼	Q4	
~	~	~	~	0.40...0.63	8.2	4	CX7-9E-10- * -AS0.63A-A10-PG▼	Q4	
~	~	1/2	3/4	0.63...1.0	13	5	CX7-9E-10- * -AS1A-A10-PG▼	Q4	
~	~	1	1	1.0...1.6	21	6	CX7-9E-10- * -AS1.6A-A10-PG▼	Q4	
1/2	3/4	1-1/2	2	1.6...2.5	33	7	CX7-9E-10- * -AS2.5A-A10-PG▼	Q4	
1	1	3	3	2.5...4	52	8	CX7-9E-10- * -AS4A-A10-PG▼	Q4	
1-1/2	2	5	~	4...6.3	82	9	CX7-9E-10- * -AS6.3A-A10-PG▼	Q4	
3	3	7-1/2	~	6.3...10	130	11	CX7-12E-10- * -AS10A-A10-PG▼	Q4	
5	5	10	~	10...16	208	28	CX7-16E-10- * -AS16A-A10-PG▼	Q4	
5	7-1/2	15	~	14.5...20	260	31	CX7-23E-10- * -AS20A-A10-PG▼	Q4	
1/2	3/4	1-1/2	2	1.6...2.5	33	17	CX7-9E-10- * -AH2.5A-A10-PG▼	Q4	
1	1	3	3	2.5...4	52	18	CX7-9E-10- * -AH4A-A10-PG▼	Q4	
1-1/2	2	5	5	4...6.3	82	12	CX7-9E-10- * -AH6.3A-A10-PG▼	Q4	
3	3	7-1/2	10	6.3...10	130	14	CX7-12E-10- * -AH10A-A10-PG▼	Q4	
5	5	10	~	10...16	208	28	CX7-16E-10- * -AH16A-A10-PG▼	Q4	
5	7-1/2	15	~	14.5...20	260	31	CX7-23E-10- * -AH20A-A10-PG▼	Q4	
5	7-1/2	15	~	18...25	325	33	CX7-23E-10- * -AH25A-A10-PG▼	Q4	

Includes:

- Type 1/12K Non-metallic enclosure (KS7-COC4R)
- KTA7 "Type E/F" Self-protected Combination Motor Controller with 1 NO front mount Auxiliary Contact (Cat #: KT7-PE1-10)
- Terminal Adaptor for Type E Applications (Cat.# KT7-25-TE1)
- CA7 contactors (for remote operation), with Electronic DC Coil
- Gray and black Type 1/12K; IP66 handle (KT7-SHB) + KT7-KN1 ⑥
- Power wiring
- Factory installed Pilot device option ⑥

Replace ▼ with option code. See page F103 for factory installed modifications

Contactor Electronic DC Coil Codes (*) ④

DC Coil Codes	Voltage
12E	12V
24E	24V
36E	36-48V
48E	48-72V
110E	110-125V
220E	220-250V

KWIKstarter coils are wired standard from the factory to terminals "L1" and "L2" (for line voltage control). This means the coil voltage must match the line voltage. When a coil is specified for 120V or less, it will be wired for a separate control source (not wired to L1 and L2).

- ① Horsepower ratings shown in the table above are for reference. The final selection of the controller depends on the actual motor full load current and service factor. For motor with service factor less than 1.15. Use motor nameplate full load current times 0.9 and choose the motor starter with the appropriate current range. Example: Motor FLC = 4.2A; S.F. = 1.0. 4.2A x 0.9 = 3.78A. Select catalog number KTA7-25S-4A.
- ② Magnetic trip is fixed at 13x the maximum value of the current adjustment range.
- ③ CX7 may be applied to single phase loads. Contact factory for these specifications.
- ④ CX7-9E...23E with electronic coils are not interchangeable with non-electronic DC or AC coils.
- ⑤ KAIC Assembly Rating Index. See pages F73-F76 for Application Rating Guide.

- ⑥ One Pilot Device option must be selected. Plastic Bezel is standard. Pilot Device options include D7-BX_ Base Mounted contact blocks. Pilot Light option must match coil voltage 24V AC or DC, 120V AC or 240V AC only. See Section H for more information.
- ⑦ CPT not possible with KS7-COC4R. Refer to page F118 for wiring diagram and F119 for dimensional information.
- ⑧ A red and yellow handle may be selected instead of the standard gray and black handle. Change "PG" suffix to "PJ". Ex: Change CX7-9-10-~~*~~-AS0.16A-A10-PG▼ to CX7-9-10-~~*~~-AS0.16A-A10-PJ▼.

Enclosed Non-Reversing Combination Controller with E-Stop, AC Operation - Type 1/12K/IP66 ①⑦⑧

Amp / Horsepower Rating				Non-Metallic Type 1/12K/IP66 Enclosure (KS7-C0C4R)				Dimension Code
Max. Horsepower ②③④				O/L Relay Ampere Range	Magnetic Response Current	Index ⑥	Catalog Number ⑤⑦⑨⑩	
Three Phase								
200V	230V	460V	575V					
KTA7-25S Standard Interrupting Capacity								
~	~	~	~	0.10...0.16	2.1	1	CX7-9-10-*AS0.16A-A10-PG4U-9	Q4
~	~	~	~	0.16...0.25	3.3	2	CX7-9-10-*AS0.25A-A10-PG4U-9	Q4
~	~	~	~	0.25...0.40	5.2	3	CX7-9-10-*AS0.4A-A10-PG4U-9	Q4
~	~	~	~	0.40...0.63	8.2	4	CX7-9-10-*AS0.63A-A10-PG4U-9	Q4
~	~	1/2	3/4	0.63...1.0	13	5	CX7-9-10-*AS1A-A10-PG4U-9	Q4
~	~	1	1	1.0...1.6	21	6	CX7-9-10-*AS1.6A-A10-PG4U-9	Q4
1/2	3/4	1-1/2	2	1.6...2.5	33	7	CX7-9-10-*AS2.5A-A10-PG4U-9	Q4
1	1	3	3	2.5...4	52	8	CX7-9-10-*AS4A-A10-PG4U-9	Q4
1-1/2	2	5	~	4...6.3	82	9	CX7-9-10-*AS6.3A-A10-PG4U-9	Q4
3	3	7-1/2	~	6.3...10	130	11	CX7-9-10-*AS10A-A10-PG4U-9	Q4
5	5	10	~	10...16	208	13	CX7-9-10-*AS16A-A10-PG4U-9	Q4
5	7-1/2	15	~	14.5...20	325	15	CX7-23-10-*AS20A-A10-PG4U-9	Q4
1/2	3/4	1-1/2	2	1.6...2.5	33	17	CX7-9-10-*AH2.5A-A10-PG4U-9	Q4
1	1	3	3	2.5...4	52	19	CX7-9-10-*AH4A-A10-PG4U-9	Q4
1/1/2	2	5	5	4...6.3	82	22	CX7-9-10-*AH6.3A-A10-PG4U-9	Q4
3	3	7-1/2	10	6.3...10	130	24	CX7-12-10-*AH10A-A10-PG4U-9	Q4
5	5	10	15	10...16	208	28	CX7-16-10-*AH16A-A10-PG4U-9	Q4
5	7-1/2	15	~	14.5...20	325	31	CX7-23-10-*AH20A-A10-PG4U-9	Q4
5	7-1/2	15	~	18...25	325	33	CX7-23-10-*AH25A-A10-PG4U-9	Q4



Includes:

- Type 1/12K Non-metallic enclosure (KS7-C0C4R) ①
- KTA7 "Type E/F" Self-protected Combination Motor Controller with 1 NO front mount Auxiliary Contact (Cat #: KT7-PE1-10)
- Terminal Adaptor for Type E Applications (Cat.# KT7-25-TE1)
- CA7 contactor (for remote operation), AC coil
- Multifunction 2-position Push Button and Emergency Stop ⑦
- Gray and black Type 1/12K; IP66 handle (KT7-SHB + KT7-KN1) ⑨
- Power wiring

This is a factory assembly.
Optional factory modifications are not available on this device.

Contactor AC Coil Codes (*) ⑤

AC Coil Code	Voltage Range	
	50 Hz	60 Hz
24Z	24V	24V
120	110V	120V
220W	200-220V	208-240V
415	400-415V	~
480 ⑩	440V	480V
600 ⑩	550V	600V

KWIKstarter coils are wired standard from the factory to terminals "L1" and "L2" (for line voltage control). This means the coil voltage must match the line voltage. When a coil is specified for 120V or less, it will be wired for a separate control source (not wired to L1 and L2).

- ① This is a factory assembly. The KS7-C0C4R does not include knock-outs for field assembly of this starter.
- ② Horsepower ratings shown in the table above are for reference. The final selection of the controller depends on the actual motor full load current and service factor. For motor with service factor less than 1.15. Use motor nameplate full load current times 0.9 and choose the motor starter with the appropriate current range. Example: Motor FLC = 4.2A; S.F. = 1.0. 4.2A x 0.9 = 3.78A. Select catalog number KTA7-25S-4A.
- ③ Magnetic trip is fixed at 13x the maximum value of the current adjustment range.
- ④ CX7 may be applied to single phase loads. Contact factory for these specifications.
- ⑤ Other voltages available, see Section A in this catalog.
- ⑥ KAIC Assembly Rating Index. See pages F73-F76 for Application Rating Guide.
- ⑦ Uses D7P-U2EFFEPX11 Two-Position Multifunction push button with legend I/O and D7P-MT44PX01 Emergency Stop Push Button.

- ⑧ CPT not possible with KS7-C0C4R. Refer page F119 for dimensional information.
- ⑨ A red and yellow handle may be selected instead of the standard gray and black handle. Change "PG" suffix to "PJ". Ex: CX7-9-10-*AS0.16A-A10-PG4U-9 becomes CX7-9-10-*AS0.16A-A10-PJ4U-9.
- ⑩ Catalog number (-A10) includes front-mounted auxiliary KT7-PE1-10 with 300 VAC maximum control circuit matching line voltage, or provided from separate source, used to de-energize contactor coil under fault condition (auxiliary not available for customer use). For control circuits greater than 300 VAC, which is common with line voltage, the auxiliary will not be wired into the control circuit since the contactor coil will be de-energized when KTA7 is tripped due to overload or short circuit; therefore, the KT7-PE1-10 auxiliary is available for customer use.

Section Obsolete
See pages F1.56 - F1.88

Enclosed Reversing Combination Controller, AC Operation - Type 1/12K/IP66 ⑥⑦

Amp / Horsepower Rating					Non-Metallic Type 1/12K/IP66 Enclosure (KS7-C0C4R)			Dimension Code
Max. Horsepower ①②③				O/L Relay Ampere Range	Magnetic Response Current	Index ⑤	Catalog Number ④⑥⑧⑨	
Three Phase								
200V	230V	460V	575V	KTA7-25S Standard Interrupting Capacity				
~	~	~	~	0.10...0.16	2.1	1	CXU7-9-22-*AS0.16A-A10-PG▼	Q4
~	~	~	~	0.16...0.25	3.3	2	CXU7-9-22-*AS0.25A-A10-PG▼	Q4
~	~	~	~	0.25...0.40	5.2	3	CXU7-9-22-*AS0.4A-A10-PG▼	Q4
~	~	~	~	0.40...0.63	8.2	4	CXU7-9-22-*AS0.63A-A10-PG▼	Q4
~	~	1/2	3/4	0.63...1.0	13	5	CXU7-9-22-*AS1A-A10-PG▼	Q4
~	~	1	1	1.0...1.6	21	6	CXU7-9-22-*AS1.6A-A10-PG▼	Q4
1/2	3/4	1-1/2	2	1.6...2.5	33	7	CXU7-9-22-*AS2.5A-A10-PG▼	Q4
1	1	3	3	2.5...4	52	8	CXU7-9-22-*AS3A-A10-PG▼	Q4
1-1/2	2	5	~	4...6.3	82	9	CXU7-9-22-*AS4A-A10-PG▼	Q4
3	3	7-1/2	~	6.3...10	130	10	CXU7-9-22-*AS10A-A10-PG▼	Q4
5	5	10	~	10...16	208	28	CXU7-16-22-*AS16A-A10-PG▼	Q4
5	7-1/2	15	~	14.5...20	260	31	CXU7-23-22-*AS20A-A10-PG▼	Q4
KTA7-40H High Interrupting Capacity								
1/2	3/4	1-1/2	2	1.6...2.5	33	17	CXU7-9-22-*AH2.5A-A10-PG▼	Q4
1	1	3	3	2.5...4	52	18	CXU7-9-22-*AH4A-A10-PG▼	Q4
1-1/2	2	5	5	4...6.3	82	22	CXU7-9-22-*AH6.3A-A10-PG▼	Q4
3	3	7-1/2	10	6.3...10	130	24	CXU7-12-22-*AH10A-A10-PG▼	Q4
5	5	10	~	10...16	208	28	CXU7-16-22-*AH16A-A10-PG▼	Q4
5	7-1/2	15	~	14.5...20	260	31	CXU7-23-22-*AH20A-A10-PG▼	Q4
5	7-1/2	15	~	18...25	325	33	CXU7-23-22-*AH25A-A10-PG▼	Q4

Includes:

- Type 1/12K Non-metallic enclosure (KS7-C0C4R)
- KTA7 "Type E/F" Self-protected Combination Motor Controller with 1 NO front mount Auxiliary Contact (Cat #: KT7-PE1-10)
- Terminal Adaptor for Type E Applications (Cat.# KT7-25-TE1)
- CA7 contactor (for remote operation), AC coil
- Gray and black Type 1/12K; IP66 handle (KT7-SHB + KT7-KN1) ⑧
- Power wiring
- Factory installed Pilot device option ⑥

Replace ▼ with option code. See page F103 for factory installed modifications

Contactor

AC Coil Codes (*) ④

AC Coil Code	Voltage Range	
	50 Hz	60 Hz
24Z	24V	24V
120	110V	120V
220W	200V-220V	208V-240V
415	400-415V	~
480 ⑨	440V	480V
600 ⑨	550V	600V

KWIKstarter coils are wired standard from the factory to terminals "L1" and "L2" (for line voltage control). This means the coil voltage must match the line voltage. When a coil is specified for 120V or less, it will be wired for a separate control source (not wired to L1 and L2).

- ① Horsepower ratings shown in the table above are for reference. The final selection of the controller depends on the actual motor full load current and service factor. For motor with service factor less than 1.15. Use motor nameplate full load current times 0.9 and choose the motor starter with the appropriate current range. Example: Motor FLC = 4.2A; S.F. = 1.0. 4.2A x 0.9 = 3.78A. Select catalog number KTA7-25S-4A.
- ② Magnetic trip is fixed at 13x the maximum value of the current adjustment range.
- ③ CXU7 may be applied to single phase loads. Contact factory for specifications.
- ④ Other voltages available, see Section A in this catalog.
- ⑤ KAIC Assembly Rating Index. See pages F73-F76 for Application Rating Guide.
- ⑥ One Pilot Device option must be selected. Plastic Bezel is standard. Pilot Device options include D7-BX Base Mounted contact blocks. Pilot Light option must match coil voltage 24V AC or DC, 120V AC or 240V AC only. See Section H for more information.

- ⑦ CPT not possible with KS7-C0C4R. Refer to page F118 for wiring diagram and F119 for dimensional information.
- ⑧ A red and yellow handle may be selected instead of the standard gray and black handle. Change "PG" suffix to "PJ". Ex: Change CXU7-9-10-*AS0.16A-A10-PG▼ to CXU7-9-10-*AS0.16A-A10-PJ▼.
- ⑨ Catalog number (-A10) includes front-mounted auxiliary KT7-PE1-10 with 300 VAC maximum control circuit matching line voltage, or provided from separate source, used to de-energize contactor coil under fault condition (auxiliary not available for customer use). For control circuits greater than 300 VAC, which is common with line voltage, the auxiliary will not be wired into the control circuit since the contactor coil will be de-energized when KTA7 is tripped due to overload or short circuit; therefore, the KT7-PE1-10 auxiliary is available for customer use.

Enclosed Reversing Combination Controller, Electronic DC Operation - Type 1/12K/IP66 ④⑥⑦

Amp / Horsepower Rating				Non-Metallic Type 1/12K/IP66 Enclosure (KS7-COC4R)				Dimension Code
Max. Horsepower ①②③				O/L Relay Ampere Range	Magnetic Response Current	Index ⑤	Catalog Number ④⑥⑧	
Three Phase								
200V	230V	460V	575V	KTA7-25S Standard Interrupting Capacity				
~	~	~	~	0.10...0.16	2.1	1	CXU7-9E-22-*AS0.16A-A10-PG▼	Q4
~	~	~	~	0.16...0.25	3.3	2	CXU7-9E-22-*AS0.25A-A10-PG▼	Q4
~	~	~	~	0.25...0.40	5.2	3	CXU7-9E-22-*AS0.4A-A10-PG▼	Q4
~	~	~	~	0.40...0.63	8.2	4	CXU7-9E-22-*AS0.63A-A10-PG▼	Q4
~	~	1/2	3/4	0.63...1.0	13	5	CXU7-9E-22-*AS1A-A10-PG▼	Q4
~	~	1	1	1.0...1.6	21	6	CXU7-9E-22-*AS1.6A-A10-PG▼	Q4
1/2	3/4	1-1/2	2	1.6...2.5	33	7	CXU7-9E-22-*AS2.5A-A10-PG▼	Q4
1	1	3	3	2.5...4	52	8	CXU7-9E-22-*AS4A-A10-PG▼	Q4
1-1/2	2	5	~	4...6.3	82	9	CXU7-9E-22-*AS6.3A-A10-PG▼	Q4
3	3	7-1/2	~	6.3...10	130	11	CXU7-9E-22-*AS10A-A10-PG▼	Q4
5	5	10	~	10...16	208	12	CXU7-9E-22-*AS16A-A10-PG▼	Q4
5	7-1/2	15	~	14.5...20	260	13	CXU7-23E-22-*AS20A-A10-PG▼	Q4
1/2	3/4	1-1/2	2	1.6...2.5	33	17	CXU7-9E-22-*AH2.5A-A10-PG▼	Q4
1	1	3	3	2.5...4	52	19	CXU7-9E-22-*AH4A-A10-PG▼	Q4
1-1/2	2	5	5	4...6.3	82	21	CXU7-9E-22-*AH6.3A-A10-PG▼	Q4
3	3	7-1/2	10	6.3...10	130	22	CXU7-12E-22-*AH10A-A10-PG▼	Q4
5	5	10	15	10...16	208	28	CXU7-16E-22-*AH16A-A10-PG▼	Q4
5	7-1/2	15	~	14.5...20	260	31	CXU7-23E-22-*AH20A-A10-PG▼	Q4
5	7-1/2	15	~	18...25	325	33	CXU7-23E-22-*AH25A-A10-PG▼	Q4



Includes:

- Type 1/12K Non-metallic enclosure (KS7-COC4R)
- KTA7 "Type E/F" Self-protected Combination Motor Controller with 1 NO front mount Auxiliary Contact (Cat #: KT7-PE1-10)
- Terminal Adaptor for Type E Applications (Cat.# KT7-25-TE1)
- CA7 contactors (for remote operation), with Electronic DC coil
- Gray and black Type 1/12K; IP66 handle (KT7-SHB + KT7-KN1) ⑧
- Power wiring
- Factory installed Pilot device option ⑥

Replace ▼ with option code. See page F103 for factory installed modifications

Control Electronic DC Coil Codes (*) ④

DC Coil Codes	Voltage
12E	12V
24E	24V
36E	36-48V
48E	48-72V
110E	110-125V
220E	220-250V

KWIKstarter coils are wired standard from the factory to terminals "L1" and "L2" (for line voltage control). This means the coil voltage must match the line voltage. When a coil is specified for 120V or less, it will be wired for a separate control source (not wired to L1 and L2).

Section Obsolete
See pages F1.56 - F1.88

- ① Horsepower ratings shown in the table above are for reference. The final selection of the controller depends on the actual motor full load current and service factor. For motor with service factor less than 1.15. Use motor nameplate full load current times 0.9 and choose the motor starter with the appropriate current range. Example: Motor FLC = 4.2A; S.F. = 1.0. 4.2A x 0.9 = 3.78A. Select catalog number KTA7-25S-4A.
- ② Magnetic trip is fixed at 13x the maximum value of the current adjustment range.
- ③ CXU7 may be applied to single phase loads. Contact factory for these specifications.
- ④ CXU7-9E...23E with electronic coils are not interchangeable with non-electronic DC or AC coils.
- ⑤ KAIC Assembly Rating Index. See pages F73-F76 for Application Rating Guide.

- ⑥ One Pilot Device option must be selected. Blanks are not available. Plastic Bezel is standard. Pilot Device options include D7-BX Base Mounted contact blocks. Pilot Light option must match coil voltage 24V AC or DC, 120V AC or 240V AC only. See Section H for more information.
- ⑦ CPT not possible with KS7-COC4R. Refer to page F118 for wiring diagram and F119 for dimensional information.
- ⑧ A red and yellow handle may be selected instead of the standard gray and black handle. Change "PG" suffix to "PJ". Ex: Change CXU7-9-10-*AS0.16A-A10-PG▼ to CXU7-9-10-*AS0.16A-A10-PJ▼.

Enclosed Motor Circuit Controllers

CX7 Non-Reversing Controller Modifications

Pilot Device Options - required	
Select one option only ①②③	Replace ▼ in catalog number with
START-STOP Multi-function	3U
I-O Multi-function	4U
OFF-ON 2-Position Selector switch	6
HAND-OFF-AUTO 3-Position Selector switch	7
Run Pilot Light Green	1G
Run Pilot Light Red	1R
Overload Alarm Pilot Light	1Y
D7-N8 22mm Hole Plug	0
Additional KT7 Auxiliaries & Trip Contacts	
Front Mount 300V maximum	
1 NO + 1 NC Auxiliary	-A11
2 NO Auxiliaries	-A20
1 NO SC+OL + 1 NC Auxiliary	-T10A01
1 NO SC+OL + 1 NO Auxiliary	-T10A10

CX7 Non-Reversing Controller Additions

Addition	Add to end of catalog number
CA7 Contactor Accessories	
Electronic Interface ④	-JE
Surge Suppressor RC	-R
Surge Suppressor Varistor	-V
CA7 Auxiliary Contacts ⑤⑥	
1 NO Auxiliary	-S10
1 NC Auxiliary	-S01
1 NO + 1 NC Auxiliary	-S1
2 NO Auxiliaries	-S20
2 NC Auxiliaries	-S02
Alternate Aux. Contact Alternative (on CX7 only)	
1 NC in lieu of standard 1 NO	-SX10
2 NC in lieu of standard 2 NO (on CXU7 only)	-SX2
Unwired Terminal Blocks Specify quantity (▼)	-▼TB

CXU7 Reversing Controller Modifications

Pilot Device Options - required	
Select one option only ①②③	Replace ▼ in catalog number with
FOR-STOP-REV Multi-function	3U
UP-STOP-DOWN Multi-function	4U
OPEN-STOP-CLOSE Multi-function	5U
FOR-STOP-REV 3-Position Selector switch	6
UP-OFF-DOWN 3-Position Selector switch	7
OPEN-OFF-CLOSE 3-Position Selector switch	8
Overload Alarm Pilot Light	1Y
D7-N8 22mm Hole Plug	0
Additional KT7 Auxiliaries & Trip Contacts	
Front Mount 300V maximum	
1 NO + 1 NC Auxiliary	-A11
2 NO Auxiliaries	-A20
1 NO SC+OL + 1 NC Auxiliary	-T10A01
1 NO SC+OL + 1 NO Auxiliary	-T10A10

CXU7 Reversing Controller Additions

Addition	Add to end of catalog number
CA7 Contactor Accessories	
Electronic Interface ④	-JE
Surge Suppressor RC	-R
Surge Suppressor Varistor	-V

Section Obsolete
See pages F1.56 - F1.88

- ① KS7-C0C4R only has (1) 22mm hole to accommodate (1) pilot device.
- ② Currently supply D7 multi-function pushbuttons as standard which do not require protective boots to meet Type 4X. See Section H in this catalog for description (all suffix's ending in "U").
- ③ Pilot Lights may be applied with 24VAC/VDC, 120VAC or 240VAC Control Circuit. Pilot Lights with 380 VAC...575VAC require a control circuit



- transformer.
- ④ CRI7E-24 will be used. CRI7E-12 by special order only.
- ⑤ See page A47 for limitations on adding auxiliaries to Electronic DC Coil contactors.
- ⑥ Additional auxiliaries are per contactor. Number of auxiliaries is double for reversing applications.

F
Enclosed Motor Circuit Controllers



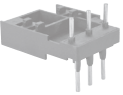

CX7 KWIKstarter Enclosures for use with KTA7 Type E Motor Controllers and CA7 Contactors ①③

Component	Description	For Use With		Environmental Approvals	Catalog Number
		Type E Controller	Contactors		
	Enclosure for Combo KWIKstarter ① CX7/CXU7-9...23 CX7/CXU7-9E...23E	KTA7-25S KTA7-25H	CA7-9...23 CA7-9E...23E CAU7-9...23 CAU7-9E...23E	cUL Type 1/12K IEC IP66	KS7-C0C4R

Handle Accessory for CX7/CXU7 KWIKstarters ①

Accessory	Description	For Use With	Color	Catalog Number
	Door Coupling Handle ① • Padlockable • NEMA Type 1/12K and IP66 • Includes handle coupling (shaft) • Requires KT7-KN1 Locking Knob	All KT7s	Gray/Black	KT7-SHB
			Red/Yellow	KT7-SHBY
	Lockable Twist Knob • for use with KT7-SHB	All KT7s	Gray/Black	KT7-KN1
	Universal Connector for CX7/CXU7 • Provides electrical interconnection of KTA7 and CA7 (with AC or Electronic DC coil) • Applies to FVNR and FVR versions • Allows for mounting the CA7 on a single DIN rail	All KT7s	Black	KT7-25S-1-23A ②

CX7 KWIKstarter Pilot Device Kits (for use with KS7-C0C4R Type 1/12K) ①②

Kits	Description	Contact Blocks Included		Catalog Number		
		NO	NC			
	Multi-Function Pushbutton kit Non-illuminated START-STOP I-O	1	1	KS7-P3U KS7-P4U	See page C29 for	
	FOR-STOP-REV UP-STOP-DOWN OPEN-STOP-CLOSE	2	1	KS7-P3U-REV KS7-P4U-REV KS7-P5U-REV		
	Selector switch kits Non-illuminated, includes legend plate					
	ON-OFF 2-Position	1	0	KS7-P6		
	HAND-OFF-AUTO 3-Position	2	0	KS7-P7		
	Run Pilot Light or Overload Alarm Pilot Light Plastic operator with diffuser lens in Red, Green or Yellow, with integrated LED power module			Replace ⑤ with color choice R = Red G = Green Y = Yellow		KS7-P1⑥24V ⑥ KS7-P1⑥120V KS7-P1⑥240V
	FOR-OFF-REV 3-Position UP-OFF-DOWN 3-Position OPEN-OFF-CLOSE 3-Position	2	0			
	Hole Plug used to plug 22.5mm holes.			Gray Plastic		D7-N8 See page H72

① KS7-C0C4R is supplied with the following holes:
• (1) one 22mm hole for a Pilot Device option, select one kit from this page.
• (1) one 22mm hole for KT7-SHB (or SHRY) Disconnect or Reset handle.

② Plastic bezel is standard. Pilot Device Kits include D7-BX_ Base Mounted contact blocks. See Section H for more information.

③ CPT not possible.

④ Standard KT7-25S-PEC23 does not work in CX7/CXU7 Kwikstarters.

⑤ KS7-P1⑥24V can be used with 24VAC or 24VDC.

F Enclosed Motor Circuit Controllers

Section Obsolete
See pages F1.56 - F1.88

Enclosed Non-Reversing Combination Controller, AC Operation - Type 4 / 12

Amp / Horsepower Rating					Painted Steel, Type 4 / 12 Enclosure			Dimension Code
Max. Horsepower ①②③				O/L Relay Ampere Range	Magnetic Response Current	Index ④	Catalog Number ⑤⑦	
Three Phase								
200V	230V	460V	575V					
KTA7-25S Standard Interrupting Capacity								
~	~	~	~	0.10...0.16	2.1	1	CX7-9-10-*-AS0.16A-A10-WG	W6
~	~	~	~	0.16...0.25	3.3	2	CX7-9-10-*-AS0.25A-A10-WG	W6
~	~	~	~	0.25...0.40	5.2	3	CX7-9-10-*-AS0.4A-A10-WG	W6
~	~	~	~	0.40...0.63	8.2	4	CX7-9-10-*-AS0.63A-A10-WG	W6
~	~	1/2	3/4	0.63...1.0	13	5	CX7-9-10-*-AS1A-A10-WG	W6
~	~	1	1	1.0...1.6	21	6	CX7-9-10-*-AS1.6A-A10-WG	W6
1/2	3/4	1-1/2	2	1.6...2.5	33	7	CX7-9-10-*-AS2.5A-A10-WG	W6
1	1	3	3	2.5...4	52	8	CX7-9-10-*-AS4A-A10-WG	W6
1-1/2	2	5	~	4...6.3	82	9	CX7-9-10-*-AS6.3A-A10-WG	W6
3	3	7-1/2	~	6.3...10	130	10	CX7-12-10-*-AS10A-A10-WG	W6
5	5	10	~	10...16	208	11	CX7-16-10-*-AS16A-A10-WG	W6
5	7-1/2	15	~	16...20	260	15	CX7-23-10-*-AS20A-A10-WG	W6
KTA7-25H High Interrupting Capacity								
1/2	3/4	1-1/2	2	1.6...2.5	33	17	CX7-9-10-*-AH2.5A-A10-WG	W6
1	1	3	3	2.5...4	52	18	CX7-9-10-*-AH4A-A10-WG	W6
1-1/2	2	5	5	4...6.3	82	22	CX7-9-10-*-AH6.3A-A10-WG	W6
3	3	7-1/2	10	6.3...10	130	24	CX7-12-10-*-AH10A-A10-WG	W6
5	5	10	15	10...16	208	28	CX7-16-10-*-AH16A-A10-WG	W6
5	7-1/2	15	~	14.5...20	260	31	CX7-23-10-*-AH20A-A10-WG	W6
5	7-1/2	15	~	18...25	325	33	CX7-23-10-*-AH25A-A10-WG	W6
KTA7-45H High Interrupting Capacity								
3	3	7-1/2	10	6.3...10	130	36	CX7-30-10-*-AH10A-A10-WG	W7
5	5	10	15	10...16	208	37	CX7-30-10-*-AH16A-A10-WG	W7
5	7-1/2	15	20	14.5...20	260	38	CX7-30-10-*-AH20A-A10-WG	W7
7-1/2	10	20	20	18...25	325	39	CX7-30-10-*-AH25A-A10-WG	W7
7-1/2	10	20	25	23...32	416	41	CX7-30-10-*-AH32A-A10-WG	W7
10	10	25	~	32...45	585	45	CX7-37-10-*-AH45A-A10-WG	W7
10	15	30	~	32...45	585	46	CX7-43-10-*-AH45A-A10-WG	W7

Painted Steel, Type 4 / 12 Enclosure

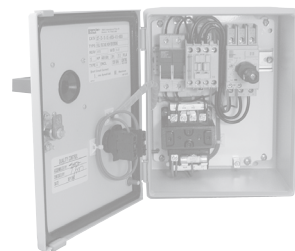

Includes:

- Type 4 / 12 enclosure - watertight, dustight
- KTA7 "Type E/F" Self-protected Combination Motor Controller with 1 NO front mount Auxiliary Contact (Cat #: KT7-PE1-10)
- Terminal Adaptor for Type E Applications (Cat.# KT7-25-TE1 or KT7-45-TE)
- CA7 contactor (for remote operation), AC coil
- Power wiring
- Gray and black Type 4/4X/12; IP66 handle (Cat.# KT7-HTN) ④
- Pilot device shown is factory installed option

See page F109 for factory installed modifications

Section Obsolete
See pages F1.56 - F1.88

Contactor AC Coil Codes (*) ⑤

AC Coil Code	Voltage Range	
	50 Hz	60 Hz
24Z	24V	24V
120	110V	120V
220W	200-220V	208-240V
277	240V	277V
415 ⑦	400-415V	~
480 ⑦	440V	480V
600 ⑦	550V	600V

- ① Horsepower ratings shown in the table above are for reference. The final selection of the controller depends on the actual motor full load current and service factor.
 - For motor with service factor less than 1.15. Use motor nameplate full load current times 0.9 and choose the motor starter with the appropriate current range. Example: Motor FLC = 4.2A; S.F. = 1.0. 4.2A x 0.9 = 3.78A. Select catalog number KTA7-25S-4A.
- ② Magnetic trip is fixed at 13x the maximum value of the current adjustment range.
- ③ CX7 may be applied to single phase loads. See footnote 1 for device selection criteria. To order single phase unit, change "CX7" in catalog number to "CBX7". Three pole series connection will be provided. Ex: Change CX7-9-10-*-0.16A-A10-WG to CBX7-9-10-*-0.16A-A10-WJ.

- ④ A red and yellow handle may be selected instead of the standard gray and black handle. Change "WG" suffix to "WJ". Ex: Change CX7-9-10-*-0.16A-A10-WG to CX7-9-10-*-0.16A-A10-WJ.
- ⑤ Other voltages available, see Section A in this catalog.
- ⑥ KAIC Assembly Rating Index. See pages F73-F76 for Application Rating Guide.
- ⑦ Catalog number (-A10) includes front-mounted auxiliary KT7-PE1-10 with 300 VAC maximum control circuit matching line voltage, or provided from separate source, used to de-energize contactor coil under fault condition (auxiliary not available for customer use). For control circuits greater than 300 VAC, which is common with line voltage, the auxiliary will not be wired into the control circuit since the contactor coil will be de-energized when KTA7 is tripped due to overload or short circuit; therefore, the KT7-PE1-10 auxiliary is available for customer use.

Enclosed Non-Reversing Combination Controller, Electronic DC Coil - Type 4 / 12

Amp / Horsepower Rating					Painted Steel, Type 4 / 12 Enclosure				
Max. Horsepower ①②③					O/L Relay Ampere Range	Mag-netic Re-sponse Current	Index ⑦	Catalog Number ④	Dimension Code
Three Phase									
200V	230V	460V	575V						
KTA7-25S Standard Interrupting Capacity									
~	~	~	~	0.10...0.16	2.1	1	CX7-9E-10-**-AS0.16A-A10-WG	W6	
~	~	~	~	0.16...0.25	3.3	2	CX7-9E-10-**-AS0.25A-A10-WG	W6	
~	~	~	~	0.25...0.40	5.2	3	CX7-9E-10-**-AS0.4A-A10-WG	W6	
~	~	~	~	0.40...0.63	8.2	4	CX7-9E-10-**-AS0.63A-A10-WG	W6	
~	~	1/2	3/4	0.63...1.0	13	5	CX7-9E-10-**-AS1A-A10-WG	W6	
~	~	1	1	1.0...1.6	21	6	CX7-9E-10-**-AS1.6A-A10-WG	W6	
1/2	3/4	1-1/2	2	1.6...2.5	33	7	CX7-9E-10-**-AS2.5A-A10-WG	W6	
1	1	3	3	2.5...4	52	8	CX7-9E-10-**-AS4A-A10-WG	W6	
1-1/2	2	5	~	4...6.3	82	9	CX7-9E-10-**-AS6.3A-A10-WG	W6	
3	3	7-1/2	~	6.3...10	130	11	CX7-12E-10-**-AS10A-A10-WG	W6	
5	5	10	~	10...16	208	12	CX7-16E-10-**-AS16A-A10-WG	W6	
5	7-1/2	15	~	14.5...20	260	15	CX7-23E-10-**-AS20A-A10-WG	W6	
KTA7-25H High Interrupting Capacity									
1/2	3/4	1-1/2	2	1.6...2.5	33	17	CX7-9E-10-**-AH2.5A-A10-WG	W6	
1	1	3	3	2.5...4	52	19	CX7-9E-10-**-AH4A-A10-WG	W6	
1-1/2	2	5	5	4...6.3	82	22	CX7-9E-10-**-AH6.3A-A10-WG	W6	
3	3	7-1/2	10	6.3...10	130	24	CX7-12E-10-**-AH10A-A10-WG	W6	
5	5	10	15	10...16	208	28	CX7-16E-10-**-AH16A-A10-WG	W6	
5	7-1/2	15	~	14.5...20	260	33	CX7-23E-10-**-AH20A-A10-WG	W6	
5	7-1/2	15	~	18...25	325	35	CX7-30E-10-**-AH25A-A10-WG	W6	
KTA7-45H High Interrupting Capacity									
3	3	7-1/2	10	6.3...10	130	36	CX7-30E-10-**-AH10A-A10-WG	W7	
5	5	10	15	10...16	208	37	CX7-30E-10-**-AH16A-A10-WG	W7	
5	7-1/2	15	20	14.5...20	260	38	CX7-30E-10-**-AH20A-A10-WG	W7	
7-1/2	10	20	20	18...25	325	39	CX7-30E-10-**-AH25A-A10-WG	W7	
7-1/2	10	20	25	23...32	416	41	CX7-37E-10-**-AH32A-A10-WG	W7	
10	10	25	~	32...45	585	45	CX7-37E-10-**-AH45A-A10-WG	W7	
10	15	30	~	32...45	585	46	CX7-43E-10-**-AH45A-A10-WG	W7	

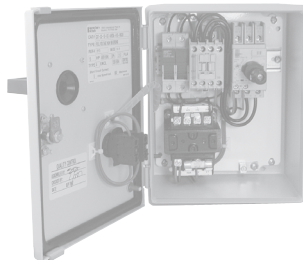

Includes:

- Type 4 / 12 enclosure - watertight, dusttight
- KT7 "Type E/F" Combination Motor Controller with 1 NO front mount Auxiliary Contact (Cat #: KT7-PE1-10)
- Terminal Adaptor for Type E Applications (Cat.# KT7-25-TE1 or KT7-45-TE)
- CA7 contactor (for remote operation), Electronic DC coil
- Power wiring
- Gray and black Type 4/4X/12; IP66 handle (Cat.# KT7-HTN) ④
- Pilot device shown is factory installed option

See page F109 for factory installed modifications

Section Obsolete
See pages F1.56 - F1.88

Contactors Electronic DC Coil Codes (*) ⑤

DC Coil Codes	Voltage
12E	12V
24E	24V
36E	36-48V
48E	48-72V
110E	110-125V
220E	220-250V

① Horsepower ratings shown in the table above are for reference. *The final selection of the controller depends on the actual motor full load current and service factor.*

- For motor with service factor less than 1.15. Use motor nameplate full load current times 0.9 and choose the motor starter with the appropriate current range. Example: Motor FLC = 4.2A; S.F. = 1.0. 4.2A x 0.9 = 3.78A. Select catalog number KTA7-25S-4A.

② Magnetic trip is fixed at 13x the maximum value of the current adjustment range.

③ CX7 may be applied to single phase loads. Contact factory for these specifications.

④ A red and yellow handle may be selected instead of the standard gray and black handle. Change "WG" suffix to "WJ". Ex: Change CX7-9E-10-**-0.16A-A10-WG to CX7-9E-10-**-0.16A-A10-WJ.

⑤ CX7-9E...43E with electronic coils are not interchangeable with non-electronic DC or AC coils.

⑦ KAIC Assembly Rating Index. See pages F73-F76 for Application Rating Guide.

Ordering Instructions

Specify Catalog Number	
Replace (*) with Coil Code	See Coil Code tables on this page for codes
Select modifications if required	

Enclosed Reversing Combination Controller, AC Operation - Type 4 / 12

Amp / Horsepower Rating					Painted Steel, Type 4 / 12 Enclosure				
Max. Horsepower ①②③				O/L Relay Ampere Range	Magnetic Response Current	Index ④	Catalog Number ⑤⑦	Dimension Code	
Three Phase									
200V	230V	460V	575V						
KTA7-25S Standard Interrupting Capacity									
~	~	~	~	0.10...0.16	2.1	1	CXU7-9-22-*AS0.16A-A10-WG	W6	
~	~	~	~	0.16...0.25	3.3	2	CXU7-9-22-*AS0.25A-A10-WG	W6	
~	~	~	~	0.25...0.40	5.2	3	CXU7-9-22-*AS0.4A-A10-WG	W6	
~	~	~	~	0.40...0.63	8.2	4	CXU7-9-22-*AS0.63A-A10-WG	W6	
~	~	1/2	3/4	0.63...1.0	13	5	CXU7-9-22-*AS1A-A10-WG	W6	
~	~	1	1	1.0...1.6	21	6	CXU7-9-22-*AS1.6A-A10-WG	W6	
1/2	3/4	1-1/2	2	1.6...2.5	33	7	CXU7-9-22-*AS2.5A-A10-WG	W6	
1	1	3	3	2.5...4	52	8	CXU7-9-22-*AS4A-A10-WG	W6	
1-1/2	2	5	~	4...6.3	82	9	CXU7-9-22-*AS6.3A-A10-WG	W6	
3	3	7-1/2	~	6.3...10	130	10	CXU7-12-22-*AS10A-A10-WG	W6	
5	5	10	~	10...16	208	11	CXU7-16-22-*AS16A-A10-WG	W6	
5	7-1/2	15	~	16...25	260	15	CXU7-23-22-*AS20A-A10-WG	W6	
KTA7-25H High Interrupting Capacity									
1/2	3/4	1-1/2	2	1.6...2.5	33	17	CXU7-9-22-*AH2.5A-A10-WG	W6	
1	1	3	3	2.5...4	52	18	CXU7-9-22-*AH4A-A10-WG	W6	
1/1/2	2	5	5	4...6.3	82	20	CXU7-9-22-*AH6.3A-A10-WG	W6	
3	3	7-1/2	10	6.3...10	130	24	CXU7-12-22-*AH10A-A10-WG	W6	
5	5	10	~	10...16	208	28	CXU7-16-22-*AH16A-A10-WG	W6	
5	7-1/2	15	~	16...25	260	31	CXU7-23-22-*AH20A-A10-WG	W6	
5	7-1/2	15	~	18...25	325	33	CXU7-23-22-*AH25A-A10-WG	W6	
KTA7-45H High Interrupting Capacity									
3	3	7-1/2	10	6.3...10	130	36	CXU7-30-22-*AH10A-A10-WG	W7	
5	5	10	15	10...16	208	37	CXU7-30-22-*AH16A-A10-WG	W7	
5	7-1/2	15	20	14.5...20	260	38	CXU7-30-22-*AH20A-A10-WG	W7	
7-1/2	10	20	20	18...25	325	39	CXU7-30-22-*AH25A-A10-WG	W7	
7-1/2	10	20	25	23...32	416	41	CXU7-37-22-*AH32A-A10-WG	W7	
10	10	25	~	32...45	585	45	CXU7-37-22-*AH45A-A10-WG	W7	
10	15	30	~	32...45	585	46	CXU7-43-22-*AH45A-A10-WG	W7	

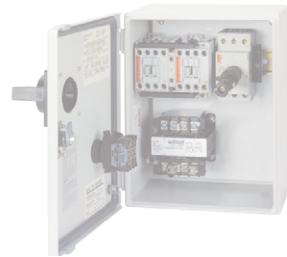

Includes:

- Type 4 / 12 enclosure - watertight, dustight
- KT7 "Type E/F" Combination Motor Controller with 1 NO front mount Auxiliary Contact (Cat #: KT7-PE1-10)
- Terminal Adaptor for Type E Applications (Cat.# KT7-25-TE1 or KT7-45-TE)
- CA7 contactors (for remote operation), AC coil
- Power wiring
- Gray and black Type 4/4X/12; IP66 handle (Cat.# KT7-HTN) ④
- Control power transformer, pilot device, terminals and other equipment shown are factory installed options

See page F109 for factory installed modifications

Section Obsolete
See pages F1.56 - F1.88

Contactor AC Coil Codes (*) ⑤

AC Coil Code	Voltage Range	
	50 Hz	60 Hz
24Z	24V	24V
120	110V	120V
220W	200-220V	208-240V
277	240V	277V
415 ⑦	400-415V	~
480 ⑦	440V	480V
600 ⑦	550V	600V

① Horsepower ratings shown in the table above are for reference. The final selection of the controller depends on the actual motor full load current and service factor.

- For motor with service factor less than 1.15. Use motor nameplate full load current times 0.9 and choose the motor starter with the appropriate current range. Example: Motor FLC = 4.2A; S.F. = 1.0. 4.2A x 0.9 = 3.78A. Select catalog number KTA7-25S-4A.

② Magnetic trip is fixed at 13x the maximum value of the current adjustment range.

③ CXU7 may be applied to single phase loads. Contact factory for these applications.

④ A red and yellow handle may be selected instead of the standard gray and black handle. Change "WG" suffix to "WJ". Ex: Change CXU7-9-10-*0.16A-A10-WG

to CXU7-9-10-*0.16A-A10-WJ.

⑤ Other voltages available, see Section A in this catalog.

⑥ KAIC Assembly Rating Index. See pages F73-F76 for Application Rating Guide.

⑦ Catalog number (-A10) includes front-mounted auxiliary KT7-PE1-10 with 300 VAC maximum control circuit matching line voltage, or provided from separate source, used to de-energize contactor coil under fault condition (auxiliary not available for customer use). For control circuits greater than 300 VAC, which is common with line voltage, the auxiliary will not be wired into the control circuit since the contactor coil will be de-energized when KTA7 is tripped due to overload or short circuit; therefore, the KT7-PE1-10 auxiliary is available for customer use.

Enclosed Reversing Combination Controller, Electronic DC Coil - Type 4 / 12

Amp / Horsepower Rating					Painted Steel, Type 4 / 12 Enclosure			Dimension Code
Max. Horsepower ①②③				O/L Relay Ampere Range	Magnetic Response Current	Index ④	Catalog Number ④	
Three Phase								
200V	230V	460V	575V					
KTA7-25S Standard Interrupting Capacity								
~	~	~	~	0.10...0.16	2.1	1	CXU7-9E-22-*AS0.16A-A10-WG	W6
~	~	~	~	0.16...0.25	3.3	2	CXU7-9E-22-*AS0.25A-A10-WG	W6
~	~	~	~	0.25...0.40	5.2	3	CXU7-9E-22-*AS0.4A-A10-WG	W6
~	~	~	~	0.40...0.63	8.2	4	CXU7-9E-22-*AS0.63A-A10-WG	W6
~	~	1/2	3/4	0.63...1.0	13	5	CXU7-9E-22-*AS1A-A10-WG	W6
~	~	1	1	1.0...1.6	21	6	CXU7-9E-22-*AS1.6A-A10-WG	W6
1/2	3/4	1-1/2	2	1.6...2.5	33	7	CXU7-9E-22-*AS2.5A-A10-WG	W6
1	1	3	3	2.5...4	52	8	CXU7-9E-22-*AS4A-A10-WG	W6
1-1/2	2	5	~	4...6.3	82	9	CXU7-9E-22-*AS6.3A-A10-WG	W6
3	3	7-1/2	~	6.3...10	130	11	CXU7-12E-22-*AS10A-A10-WG	W6
5	5	10	~	10...16	208	13	CXU7-16E-22-*AS16A-A10-WG	W6
5	7-1/2	15	~	14.5...20	260	15	CXU7-23E-22-*AS20A-A10-WG	W6
KTA7-25H High Interrupting Capacity								
1/2	3/4	1-1/2	2	1.6...2.5	33	17	CXU7-9E-22-*AH2.5A-A10-WG	W6
1	1	3	3	2.5...4	52	19	CXU7-9E-22-*AH4A-A10-WG	W6
1-1/2	2	5	5	4...6.3	82	22	CXU7-9E-22-*AH6.3A-A10-WG	W6
3	3	7-1/2	10	6.3...10	130	25	CXU7-12E-22-*AH10A-A10-WG	W6
5	5	10	15	10...16	208	28	CXU7-16E-22-*AH16A-A10-WG	W6
5	7-1/2	15	~	14.5...20	260	31	CXU7-23E-22-*AH20A-A10-WG	W6
5	7-1/2	15	~	18...25	325	33	CXU7-23E-22-*AH25A-A10-WG	W6
KTA7-45H High Interrupting Capacity								
3	3	7-1/2	10	6.3...10	130	36	CXU7-30E-22-*AH10A-A10-WG	W7
5	5	10	15	10...16	208	37	CXU7-30E-22-*AH16A-A10-WG	W7
5	7-1/2	15	20	14.5...20	260	38	CXU7-30E-22-*AH20A-A10-WG	W7
7-1/2	10	20	20	18...25	325	39	CXU7-30E-22-*AH25A-A10-WG	W7
7-1/2	10	20	25	23...32	416	41	CXU7-37E-22-*AH32A-A10-WG	W7
10	10	25	~	32...45	585	45	CXU7-37E-22-*AH45A-A10-WG	W7
10	15	30	~	32...45	585	46	CXU7-43E-22-*AH45A-A10-WG	W7



Includes:

- Type 4 / 12 enclosure - watertight, dusttight
- KT7 "Type E/F" Combination Motor Controller with 1 NO front mount Auxiliary Contact (Cat #: KT7-PE1-10)
- Terminal Adaptor for Type E Applications (Cat.# KT7-25-TE or KT7-45-TE)
- CA7 contactors (for remote operation), Electronic DC coil
- Power wiring
- Gray and black Type 4/4X/12; IP66 handle (Cat.# KT7-HTN) ④
- Control power transformer, pilot device, terminals and other equipment shown are factory installed options

See page F109 for factory installed modifications

Section Obsolete
See pages F1.56 - F1.88

Contactors Electronic DC Coil Codes (*) ⑤

DC Coil Codes	Voltage
12E	12V
24E	24V
36E	36-48V
48E	48-72V
110E	110-125V
220E	220-250V

- ① Horsepower ratings shown in the table above are for reference. *The final selection of the controller depends on the actual motor full load current and service factor.*
 - For motor with service factor less than 1.15. Use motor nameplate full load current times 0.9 and choose the motor starter with the appropriate current range. Example: Motor FLC = 4.2A; S.F. = 1.0. 4.2A x 0.9 = 3.78A. Select catalog number KTA7-25S-4A.
- ② Magnetic trip is fixed at 13x the maximum value of the current adjustment range.
- ③ CXU7 may be applied to single phase loads. Contact factory for these applications.
- ④ A red and yellow handle may be selected instead of the standard gray and black handle. Change "WG" suffix to "WJ". Ex: Change CXU7-9E-10-*0.16A-A10-WG to CXU7-9E-10-*0.16A-A10-WJ.
- ⑤ CXU7-9E...43E with electronic coils are not interchangeable with non-electronic DC or AC coils.
- ⑥ KAIC Assembly Rating Index. See pages F73-F76 for Application Rating Guide.

Ordering Instructions

Specify Catalog Number	
Replace (□) with Coil Code	See Coil Code tables on this page for codes
Select modifications if required	

Enclosed Motor Circuit Controllers

Non-Reversing and Reversing CX7 Combination Controller Modifications (Factory Assembled)

Description	Add Suffix to Catalog Number
Pilot Devices ①	
START-STOP multi-function pushbutton	3U
ON-OFF multi-function pushbutton	4U
FOR-STOP-REV multi-function pushbutton	3U
UP-STOP-DOWN multi-function pushbutton	4U
OPEN-STOP-CLOSE multi-function pushbutton	5U
HAND-AUTO selector switch	5
OFF-ON selector switch	6
HAND-OFF-AUTO selector switch	7
FOR-OFF-REV selector switch	6
UP-OFF-DOWN selector switch	7
OPEN-OFF-CLOSE selector switch	8
Pilot light only ③	1
Pilot lights only (2) ③	2
Pilot light w/ START-STOP multi-function pushbutton ③	13U
Pilot light w/ ON-OFF multi-function pushbutton ③	14U
Pilot light w/ HAND-AUTO selector switch ③	15
Pilot light w/ OFF-ON selector switch ③	16
Pilot light w/ HAND-OFF-AUTO selector switch ③	17
Control Power Transformer	
(with fused primary and secondary)	Replace (*) with the catalog # with the blue wire codes ②
Primary volts	Secondary volts
208	120
240	24
480	120
575	120
380	110
240	24
480	24
600	24
50 watt Standard Capacity	XB
	XC
	XD
	XE
	XF
	XJ
KT7 Auxiliaries & Trip Contacts ⑤	
	Change "-A10-" to ...
Front mount 300V maximum	
1 NO + 1 NC Auxiliary	-A11
2 NO Auxiliaries	-A20
1 NO SC+OL + 1 NC Auxiliary	-T10A01
1 NO SC+OL + 1 NO Auxiliary	-T10A10
Side Mount 600V maximum	
2 NC Auxiliaries	-AS02
2 NO Auxiliaries	-AS20
1 NO + 1 NC Auxiliary	-AS11
1 NC SC+OL + 1 NO Auxiliary	-R10
1 NC SC+OL + 1 NC Auxiliary	-R11

Description	Add Suffix to Catalog Number
Additional KT7 Trip Contacts - Side Mount (600V max)	
1 NO SC+OL + 1 NO SC	-R00
1 NO SC+OL + 1 NC SC	-R01
1 NC SC+OL + 1 NO SC	-R10
KT7 Accessories	
Undervoltage Release Module	Select coil voltage from table below
Shunt Release Module	-UA-* -AA-*
CA7 Auxiliary Contacts ⑥	
1 NO Auxiliary	-S10
1 NC Auxiliary	-S01
1 NO + 1 NC Auxiliary	-S11
2 NO Auxiliaries	-S20
2 NC Auxiliaries	-S02
1 NO + 2 NC Auxiliary	-S12
2 NO + 1 NC Auxiliary	-S21
3 NO Auxiliaries	-S30
3 NC Auxiliaries	-S03
1 NO + 3 NC Auxiliary	-S13
3 NO + 1 NC Auxiliary	-S31
2 NO + 1 NC Auxiliary	-S22
4 NO Auxiliaries	-S40
4 NC Auxiliaries	-S04
Alternate Aux. Contact Arrangements (7-9)	
1 NC in lieu of standard 1 NO	-SX10
2 NC in lieu of standard 2 NO (on CXU7 only)	-SX2
CA7 Contactor Accessories	
Encoder Interface	-JE ④
Surge Suppressor RC	-R
Surge Suppressor Varistor	-V
Unwired Terminal Blocks Specify quantity (▼)	-▼TB

Section Obsolete
See pages F1.56 - F1.88

-UA..-AA Coil Codes (*)

AC Coil Code	Voltage Range	
	50 Hz	60 Hz
24V	21V	24V
28V	24V	28V
120V	105V	120V
127V	110V	127V
230V	220...230V	~
240V	~	240...260V
277V	240V	277V
460V	380...400V	400...460V
480V	415V	480V
600V	550V	600V

① Currently supply D7 multi-function pushbuttons as standard which do not require protective boots to meet Type 4X. See Section H in this catalog for description (all suffix's ending in "U").
 ② Factory modifications often change the enclosure size. Refer to factory for dimensions when critical to the installation.

③ Pilot Lights may be applied with 24VAC/VDC, 120VAC or 240VAC Control Circuit. Pilot Lights with 277 VAC...575VAC require a control circuit transformer.
 ④ CRI7E-24 will be used. CRI7E-12 by special order only.
 ⑤ Additional auxiliaries are per contactor. Number of auxiliaries is double for reversing applications.

CX7 Explosion Proof Combination Controllers - NEMA Type 4/4X/7/9 with Type 4 Gaskets

Amp / Horsepower Rating					O/L Relay Ampere Range	Magnetic Response Current	Catalog Number ⑤	Dimension Code
Max. Horsepower ①②③								
Three Phase								
200V	230V	460V	575V					
KT A7-25S Standard Interrupting Capacity								
~	~	~	~	0.10...0.16	2.1	CX7-9-10*-AS0.16A-A10-EZ	EZ	
~	~	~	~	0.16...0.25	3.3	CX7-9-10*-AS0.25A-A10-EZ	EZ	
~	~	~	~	0.25...0.40	5.2	CX7-9-10*-AS0.4A-A10-EZ	EZ	
~	~	~	~	0.40...0.63	8.2	CX7-9-10*-AS0.63A-A10-EZ	EZ	
~	~	1/2	3/4	0.63...1.0	13	CX7-9-10*-AS1A-A10-EZ	EZ	
~	~	1	1	1.0...1.6	21	CX7-9-10*-AS1.6A-A10-EZ	EZ	
1/2	3/4	1-1/2	2	1.6...2.5	33	CX7-9-10*-AS2.5A-A10-EZ	EZ	
1	1	3	3	2.5...4	52	CX7-9-10*-AS4A-A10-EZ	EZ	
1-1/2	2	5	~	4...6.3	82	CX7-9-10*-AS6.3A-A10-EZ	EZ	
3	3	7-1/2	~	6.3...10	130	CX7-12-10*-AS10A-A10-EZ	EZ	
5	5	10	~	10...16	208	CX7-16-10*-AS16A-A10-EZ	EZ	
5	7-1/2	15	~	14.5...20	260	CX7-23-10*-AS20A-A10-EZ	EZ	
KT A7-25H High Interrupting Capacity								
1/2	3/4	1-1/2	2	1.6...2.5	33	CX7-9-10*-AH2.5A-A10-EZ	EZ	
1	1	3	3	2.5...4	52	CX7-9-10*-AH4A-A10-EZ	EZ	
1-1/2	2	5	5	4...6.3	82	CX7-9-10*-AH6.3A-A10-EZ	EZ	
3	3	7-1/2	10	6.3...10	130	CX7-12-10*-AH10A-A10-EZ	EZ	
5	5	10	15	10...16	208	CX7-16-10*-AH16A-A10-EZ	EZ	
5	7-1/2	15	~	14.5...20	260	CX7-23-10*-AH20A-A10-EZ	EZ	
5	7-1/2	15	~	18...25	325	CX7-30-10*-AH25A-A10-EZ	EZ	
KT A7-40 High Interrupting Capacity								
3	3	7-1/2	10	6.3...10	130	CX7-30-10*-AH10A-A10-EZ	EZ	
5	5	10	15	10...16	208	CX7-30-10*-AH16A-A10-EZ	EZ	
5	7-1/2	15	20	14.5...20	260	CX7-30-10*-AH20A-A10-EZ	EZ	
7-1/2	10	20	20	18...25	325	CX7-30-10*-AH25A-A10-EZ	EZ	
7-1/2	10	20	25	23...32	416	CX7-30-10*-AH32A-A10-EZ	EZ	
10	10	25	~	32...45	585	CX7-37-10*-AH45A-A10-EZ	EZ	
10	15	30	~	32...45	585	CX7-43-10*-AH45A-A10-EZ	EZ	



Includes:

- Class I, Div I, Group B, C & D – Class II, Div I, Group E, F & G enclosure Class III, Zone I, IIB & H2
- KT7 “Type E” Self-protected Combination Manual Motor Controller with 1 NO front mount auxiliary contact (Cat.# KT7-PE1-10)
- Terminal Adaptor for Combo Type E/F Applications (Cat.# KT7-25-TE or KT7-45-TE)
- CA7 contactor (for remote operation), AC coil
- Power wiring

Modifications (Factory Assembled)

KT7 Auxiliaries & Trip Contacts,	Change “A10” in Cat. # to...
Front Mount 300V max.	
1 NC Auxiliary	-A01
1 NO + 1 NC Auxiliary	-A11
2 NC Auxiliaries	-A20
1 NO + 1 NC + OL + 1 NC Auxiliary	-T10A01
1 NO SC + OL + 1 NO Auxiliary	-T10A10
Side Mount 600V max.	
2 NO Auxiliaries	-AS20
1 NO + 1 NC Auxiliary	-AS11
1 NC SC + OL + 1 NO Auxiliary	-R10
1 NC SC + OL + 1 NC Auxiliary	-R11
CA7 Contactor Accessories	Add Suffix to Cat. Number
1 NC Auxiliary	-S01
1 NO Auxiliary	-S10
Electronic Interface	-JE
Surge Suppressor RC	-R
Surge Suppressor Varistor	-V
Enclosure Modifications	
Dual START/STOP pushbutton	3
ON/OFF selector switch	6
H-O-A	7
Breather/Drain	-BD

Contactor AC Coil Codes (*) ④

AC Coil Code	Voltage Range	
	50 Hz	60 Hz
24Z	24V	24V
120	110V	120V
220W	200-220V	208-240V
277	240V	277V
415 ⑤	400-415V	~
480 ⑤	440V	480V
600 ⑤	550V	600V

- ① Horsepower ratings shown in the table above are for reference. *The final selection of the controller depends on the actual motor full load current and service factor.*
 - For motor with service factor less than 1.15. Use motor nameplate full load current times 0.9 and choose the motor starter with the appropriate current range. Example: Motor FLC = 4.2A; S.F. = 1.0. 4.2A x 0.9 = 3.78A. Select catalog number KTA7-25S-4A.
- ② Magnetic trip is fixed at 13x the maximum value of the current adjustment range.
- ③ CX7 may be applied to single phase loads. See footnote 1 for device selection criteria. To order single phase unit, change “CX7” in catalog number to “CBX7”. Three pole series connection will be provided. Ex: Change **CX7-9-10*-0.16A-A10-EZ** to **CBX7-9-10*-0.16A-A10-EZ**.
- ④ Other voltages available, see Section A in this catalog.
- ⑤ Catalog number (-A10) includes front-mounted auxiliary KT7-PE1-10 with 300 VAC maximum control circuit matching line voltage, or provided from separate source, used to de-energize contactor coil under fault condition (auxiliary not available for customer use). For control circuits greater than 300 VAC, which is common with line voltage, the auxiliary will not be wired into the control circuit since the contactor coil will be de-energized when KTA7 is tripped due to overload or short circuit; therefore, the KT7-PE1-10 auxiliary is available for customer use.

Ordering Instructions

Specify Catalog Number	
Replace (*) with Coil Code	See tables on this page for codes
Select modifications if required	

Section Obsolete - F1.88
see pages F1.56 - F1.88

Type E/F Simplex & Duplex Pump Controllers



Simplex Pump Controllers

A single KTA7 motor controller plus matching CA7 contactor can be combined in an enclosure as a Simplex Combination Controller for pumping applications. Additional space is provided for the customer to field addition of time clocks or float switches as required by the application. An environmentally approved thru-the-door handle provides for a required disconnect. These pump panels can be supplied with Suitable for Service Entrance (SUSE) label on demand. Type E/F pump panels are less expensive than the classic Cost-effective Type A (Fusible) or Cost-effective Type C (MCCB) versions shown in Section C of this catalog.

Type E/F Simplex Pump Controller Panels include:

- Contactor (with AC coil)
- Type E/F self-protected motor controller
- "START" Momentary Push Button
- "HOA" Selector Switch
- A minimum of 6" x 10" extra back pan space
- UL Type rated enclosure

Duplex Pump Controllers

Two starter duplex panels can be fed from one power source or two power sources and include lead/lag control circuitry to meet customers' need in pumping and many other applications. Two environmentally approved thru-the-door handle disconnect mechanisms means no main fender device is required and small footprint less expensive panel than a classic duplex panel as offered in Section C of this catalog. The following pages include a selection of duplex controllers and you can contact your Sprecher + Schuh representative to modify the selection.

Type E/F Duplex Pump Controller Panels include:

- (2) Contactors (AC coil) and (2) Type E/F self protected motor controllers
- (1) Electronic alternating relay
- (1) UL type rated enclosure
- Designed per alternation control diagram shown at bottom of page F117

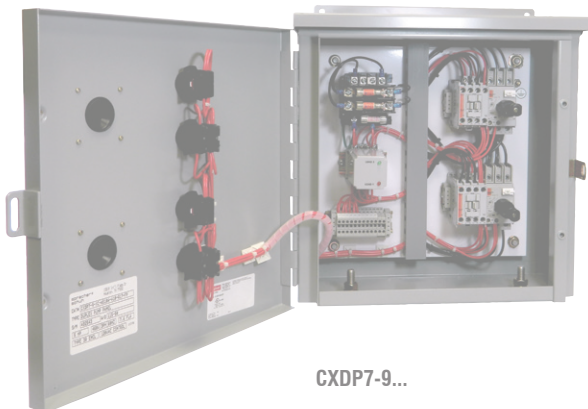

Section Obsolete
See pages F1.56 - F1.88

F
Enclosed Motor Circuit Controllers

Series CXP7 & Type E/F Combo Pump Panel

Max. Horsepower ①②③ Three Phase				Current Adjustment Range (A)	Magnetic Response Current	Type 3R Rainproof (Metal)	Dimension Code	Type 4X Watertight Corrosion Resistant Non-metallic	Dimension Code
200V	230V	460V	575V			Catalog Number ④⑥		Catalog Number ④⑥	
KTA7-25S Standard Interrupting Capacity									
~	~	~	~	0.10...0.16	2.1	CXP7-9-10-*-AS0.16A-A10-RG	0	CXP7-9-10-*-AS0.16A-A10-CG	R/F
~	~	~	~	0.16...0.25	3.3	CXP7-9-10-*-AS0.25A-A10-RG	0	CXP7-9-10-*-AS0.25A-A10-CG	R/F
~	~	~	~	0.25...0.40	5.2	CXP7-9-10-*-AS0.4A-A10-RG	0	CXP7-9-10-*-AS0.4A-A10-CG	R/F
~	~	~	~	0.40...0.63	8.2	CXP7-9-10-*-AS0.63A-A10-RG	0	CXP7-9-10-*-AS0.63A-A10-CG	R/F
~	~	1/2	3/4	0.63...1.0	13	CXP7-9-10-*-AS1A-A10-RG	0	CXP7-9-10-*-AS1A-A10-CG	R/F
~	~	1	1	1.0...1.6	21	CXP7-9-10-*-AS1.6A-A10-RG	0	CXP7-9-10-*-AS1.6A-A10-CG	R/F
1/2	3/4	1-1/2	2	1.6...2.5	33	CXP7-9-10-*-AS2.5A-A10-RG	0	CXP7-9-10-*-AS2.5A-A10-CG	R/F
1	1	3	3	2.5...4	52	CXP7-9-10-*-AS4A-A10-RG	0	CXP7-9-10-*-AS4A-A10-CG	R/F
1-1/2	2	5	~	4...6.3	82	CXP7-9-10-*-AS6.3A-A10-RG	0	CXP7-9-10-*-AS6.3A-A10-CG	R/F
3	3	7-1/2	~	6.3...10	130	CXP7-12-10-*-AS10A-A10-RG	0	CXP7-12-10-*-AS10A-A10-CG	R/F
5	5	10	~	10...16	208	CXP7-16-10-*-AS16A-A10-RG	0	CXP7-16-10-*-AS16A-A10-CG	R/F
5	7-1/2	15	~	14.5...20	260	CXP7-23-10-*-AS20A-A10-RG	0	CXP7-23-10-*-AS20A-A10-CG	R/F
KTA7-25H High Interrupting Capacity									
1/2	3/4	1-1/2	2	1.6...2.5	33	CXP7-9-10-*-AH2.5A-A10-RG	0	CXP7-9-10-*-AH2.5A-A10-CG	R/F
1	1	3	3	2.5...4	52	CXP7-9-10-*-AH4A-A10-RG	0	CXP7-9-10-*-AH4A-A10-CG	R/F
1-1/2	2	5	5	4...6.3	82	CXP7-9-10-*-AH6.3A-A10-RG	0	CXP7-9-10-*-AH6.3A-A10-CG	R/F
3	3	7-1/2	10	6.3...10	130	CXP7-12-10-*-AH10A-A10-RG	0	CXP7-12-10-*-AH10A-A10-CG	R/F
5	5	10	15	10...16	208	CXP7-16-10-*-AH16A-A10-RG	0	CXP7-16-10-*-AH16A-A10-CG	R/F
5	7-1/2	15	~	14.5...20	260	CXP7-23-10-*-AH20A-A10-RG	0	CXP7-23-10-*-AH20A-A10-CG	R/F
5	7-1/2	15	~	18...25	325	CXP7-23-10-*-AH25A-A10-RG	0	CXP7-23-10-*-AH25A-A10-CG	R/F
KTA7-45H High Interrupting Capacity									
3	3	7-1/2	10	6.3...10	130	CXP7-30-10-*-AH10A-A10-RG	Q	CXP7-30-10-*-AH10A-A10-CG	R/F
5	5	10	15	10...16	208	CXP7-30-10-*-AH16A-A10-RG	Q	CXP7-30-10-*-AH16A-A10-CG	R/F
5	7-1/2	15	20	14.5...20	260	CXP7-30-10-*-AH20A-A10-RG	Q	CXP7-30-10-*-AH20A-A10-CG	R/F
7-1/2	10	20	20	18...25	325	CXP7-30-10-*-AH25A-A10-RG	Q	CXP7-30-10-*-AH25A-A10-CG	R/F
7-1/2	10	20	25	23...32	416	CXP7-30-10-*-AH32A-A10-RG	Q	CXP7-30-10-*-AH32A-A10-CG	R/F
10	10	25	~	32...45	585	CXP7-37-10-*-AH45A-A10-RG	Q	CXP7-37-10-*-AH45A-A10-CG	R/F
10	15	30	~	32...45	585	CXP7-43-10-*-AH45A-A10-RG	Q	CXP7-43-10-*-AH45A-A10-CG	R/F

NOTE: Catalog Numbers, list Price and enclosure dimensions reflect contactors with AC coils. Contact factory for DC applications.

R/F - Experience has shown that applications using non-metallic enclosures often require customized pump panels (i.e. Door-in-Door or unique control circuit). Contact your Sprecher + Schuh representative for a customized price.

Section Obsolete
See pages F1.56 - F1.88

F Enclosed Motor Circuit Controllers

**Contactors
AC Coil Codes (*) ⑤**

AC Coil Code	Voltage Range	
	50 Hz	60 Hz
24Z	24V	24V
120	110V	120V
220W	200-220V	208-240V
277	240V	277V
415 ⑥	400-415V	~
480 ⑥	440V	480V
600 ⑥	550V	600V

- ① Horsepower ratings shown in the table above are for reference. *The final selection of the controller depends on the actual motor full load current and service factor.*
 - For motor with service factor less than 1.15. Use motor nameplate full load current times 0.9 and choose the motor starter with the appropriate current range. Example: Motor FLC = 4.2A; S.F. = 1.0. 4.2A x 0.9 = 3.78A. Select catalog number KTA7-25S-4A.
- ② Magnetic trip is fixed at 13x the maximum value of the current adjustment range.
- ③ CXP7 may be applied to single phase loads. See footnote 1 for device selection criteria. To order single phase unit, change "CXP7" in catalog number to "CBX7". Three pole series connection will be provided. Ex: Change CXP7-9-10-*-0.16A-A10-RG to CBXP7-9-10-*-0.16A-A10-RG.
- ④ A red and yellow handle may be selected instead of the standard gray and black handle. Change "RG" suffix to "RJ". Ex: Change CXP7-9-10-*-0.16A-A10-RG to CXP7-9-10-*-0.16A-A10-RJ.
- ⑤ Other voltages available, see Section A in this catalog.
- ⑥ Catalog number (-A10) includes front-mounted auxiliary KT7-PE1-10 with 300 VAC maximum control circuit matching line voltage, or provided from separate source, used to de-energize contactor coil under fault condition (auxiliary not available for customer use). For control circuits greater than 300 VAC, which is common with line voltage, the auxiliary will not be wired into the control circuit since the contactor coil will be de-energized when KTA7 is tripped due to overload or short circuit; therefore, the KT7-PE1-10 auxiliary is available for customer use.

Ordering Instructions

Specify Catalog Number	
Replace (*) with Coil Code Factory Modifications available	See this page Contact factory

Series CXDP7 with Type E/F Combination Controller

Max. Horsepower Three Phase				Current Adjustment Range (A)	Magnetic Response Current	Type 3R Rainproof (Metal)	Dimension Code	Type 4X Watertight Corrosion Resistant Non-metallic	Dimension Code
200V	230V	460V	575V			Catalog Number ②		Catalog Number ②	
KTA7-25S Standard Interrupting Capacity									
~	~	~	~	0.10...0.16	2.1	CXDP7-9-10-*AS0.16A-A10-RG	R/F	CXDP7-9-10-*AS0.16A-A10-CG	R/F
~	~	~	~	0.16...0.25	3.3	CXDP7-9-10-*AS0.25A-A10-RG	R/F	CXDP7-9-10-*AS0.25A-A10-CG	R/F
~	~	~	~	0.25...0.40	5.2	CXDP7-9-10-*AS0.4A-A10-RG	R/F	CXDP7-9-10-*AS0.4A-A10-CG	R/F
~	~	~	~	0.40...0.63	8.2	CXDP7-9-10-*AS0.63A-A10-RG	R/F	CXDP7-9-10-*AS0.63A-A10-CG	R/F
~	~	1/2	3/4	0.63...1.0	13	CXDP7-9-10-*AS1A-A10-RG	R/F	CXDP7-9-10-*AS1A-A10-CG	R/F
~	~	1	1	1.0...1.6	21	CXDP7-9-10-*AS1.6A-A10-RG	R/F	CXDP7-9-10-*AS1.6A-A10-CG	R/F
1/2	3/4	1-1/2	2	1.6...2.5	33	CXDP7-9-10-*AS2.5A-A10-RG	R/F	CXDP7-9-10-*AS2.5A-A10-CG	R/F
1	1	3	3	2.5...4	52	CXDP7-9-10-*AS4A-A10-RG	R/F	CXDP7-9-10-*AS4A-A10-CG	R/F
1-1/2	2	5	~	4...6.3	82	CXDP7-9-10-*AS6.3A-A10-RG	R/F	CXDP7-9-10-*AS6.3A-A10-CG	R/F
3	3	7-1/2	~	6.3...10	130	CXDP7-12-10-*AS10A-A10-RG	R/F	CXDP7-12-10-*AS10A-A10-CG	R/F
5	5	10	~	10...16	208	CXDP7-16-10-*AS16A-A10-RG	R/F	CXDP7-16-10-*AS16A-A10-CG	R/F
5	7-1/2	15	~	14.5...20	260	CXDP7-23-10-*AS20A-A10-RG	R/F	CXDP7-23-10-*AS20A-A10-CG	R/F
KTA7-25H High Interrupting Capacity									
1/2	3/4	1-1/2	2	1.6...2.5	33	CXDP7-9-10-*AH2.5A-A10-RG	R/F	CXDP7-9-10-*AH2.5A-A10-CG	R/F
1	1	3	3	2.5...4	52	CXDP7-9-10-*AH4A-A10-RG	R/F	CXDP7-9-10-*AH4A-A10-CG	R/F
1-1/2	2	5	5	4...6.3	82	CXDP7-9-10-*AH6.3A-A10-RG	R/F	CXDP7-9-10-*AH6.3A-A10-CG	R/F
3	3	7-1/2	10	6.3...10	130	CXDP7-12-10-*AH10A-A10-RG	R/F	CXDP7-12-10-*AH10A-A10-CG	R/F
5	5	10	15	10...16	208	CXDP7-16-10-*AH16A-A10-RG	R/F	CXDP7-16-10-*AH16A-A10-CG	R/F
5	7-1/2	15	~	14.5...20	260	CXDP7-23-10-*AH20A-A10-RG	R/F	CXDP7-23-10-*AH20A-A10-CG	R/F
5	7-1/2	15	~	18...25	325	CXDP7-30-10-*AH25A-A10-RG	R/F	CXDP7-30-10-*AH25A-A10-CG	R/F
KTA7-45H High Interrupting Capacity									
3	3	7-1/2	10	6.3...10	130	CXDP7-30-10-*AH10A-A10-RG	R/F	CXDP7-30-10-*AH10A-A10-CG	R/F
5	5	10	15	10...16	208	CXDP7-30-10-*AH16A-A10-RG	R/F	CXDP7-30-10-*AH16A-A10-CG	R/F
5	7-1/2	15	20	14...20	260	CXDP7-30-10-*AH20A-A10-RG	R/F	CXDP7-30-10-*AH20A-A10-CG	R/F
7-1/2	10	20	20	18...25	325	CXDP7-30-10-*AH25A-A10-RG	R/F	CXDP7-30-10-*AH25A-A10-CG	R/F
7-1/2	10	20	25	23...32	410	CXDP7-30-10-*AH32A-A10-RG	R/F	CXDP7-30-10-*AH32A-A10-CG	R/F
10	10	25	~	32...45	585	CXDP7-37-10-*AH45A-A10-RG	R/F	CXDP7-37-10-*AH45A-A10-CG	R/F
10	15	30	~	32...45	585	CXDP7-43-10-*AH45A-A10-RG	R/F	CXDP7-43-10-*AH45A-A10-CG	R/F

NOTE: Catalog Numbers, list prices and enclosure dimensions reflect contactors with AC coils. Contact factory for DC applications.

R/F - Experience has shown that applications using non-metallic enclosures often require customized pump panels (i.e. Door-in-Door or unique control circuit). Contact your Sprecher + Schuh representative for a customized price.

Contactors
AC Coil Codes (*) ①

AC Coil Code	Voltage Range	
	50 Hz	60 Hz
24Z	24V	24V
120	110V	120V
220W	200-220V	208-240V
277	240V	277V
415 ②	400-415V	~
480 ②	440V	480V
600 ②	550V	600V

Ordering Instructions

Specify Catalog Number	
Replace (*) with Coil Code	See this page
Factory Modifications available	Contact factory

- ① Other voltages available, see Section A in this catalog.
- ② Catalog number (-A10) includes front-mounted auxiliary KT7-PE1-10 with 300 VAC maximum control circuit matching line voltage, or provided from separate source, used to de-energize contactor coil under fault condition (auxiliary not available for customer use). For control circuits greater than 300 VAC, which is common with line voltage, the auxiliary will not be wired into the control circuit since the contactor coil will be de-energized when KTA7 is tripped due to overload or short circuit; therefore, the KT7-PE1-10 auxiliary is available for customer use.

Section Obsolete
See pages F1.56 - F1.88

Custom Multi-Starter Control Panels

From 10 to 100 or more, consult the experts

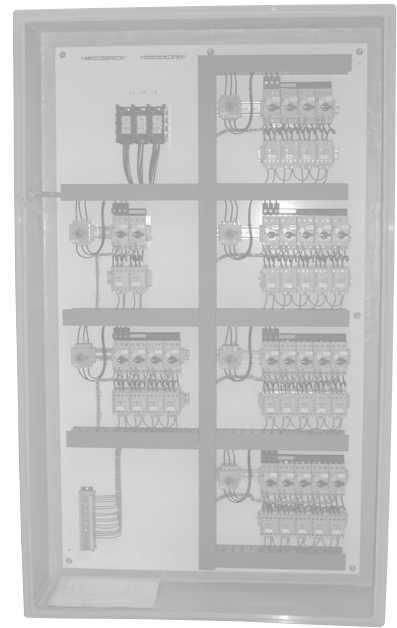
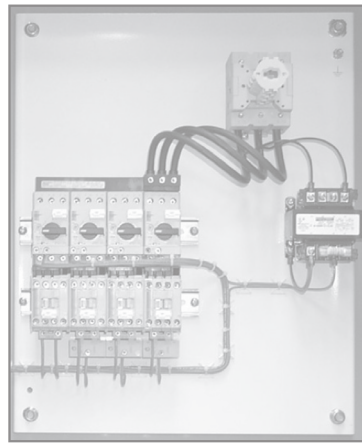

Your Motor Control + Protection Consultant

Sprecher + Schuh's slogan is "Motor control + protection consultant". This means part of our job is to be knowledgeable about these issues and to help customers choose components that not only comply with UL, NEC and CSA standards but also maximizes the SCCR rating of the assembled multi-starter panel, leading to increased protection of equipment and personnel.

Multiple KTU7, KTU7 or KTC7 motor controllers plus matching C75 contactors can be combined in a single assembly as a multi-motor starter custom control panel. Three, 5, 153 or more motor controllers and KTU7 molded case circuit breakers, as well as other power components and control circuits, can be designed and

assembled into a custom multi-motor starter by Sprecher + Schuh to meet customers' unique application requirements. These pages include a few pictures of custom multi-motor control panels built by Sprecher + Schuh. Contact your Sprecher + Schuh motor control and protection representative for consultation regarding design, quotations, or help explaining the complex UL, NEC and CSA codes that apply to a custom assembly.

Section Obsolete
See pages F1.56 - F1.88

Enclosed Motor Circuit Controllers

For your Custom application

contact
customquotes@sprecherschuh.com

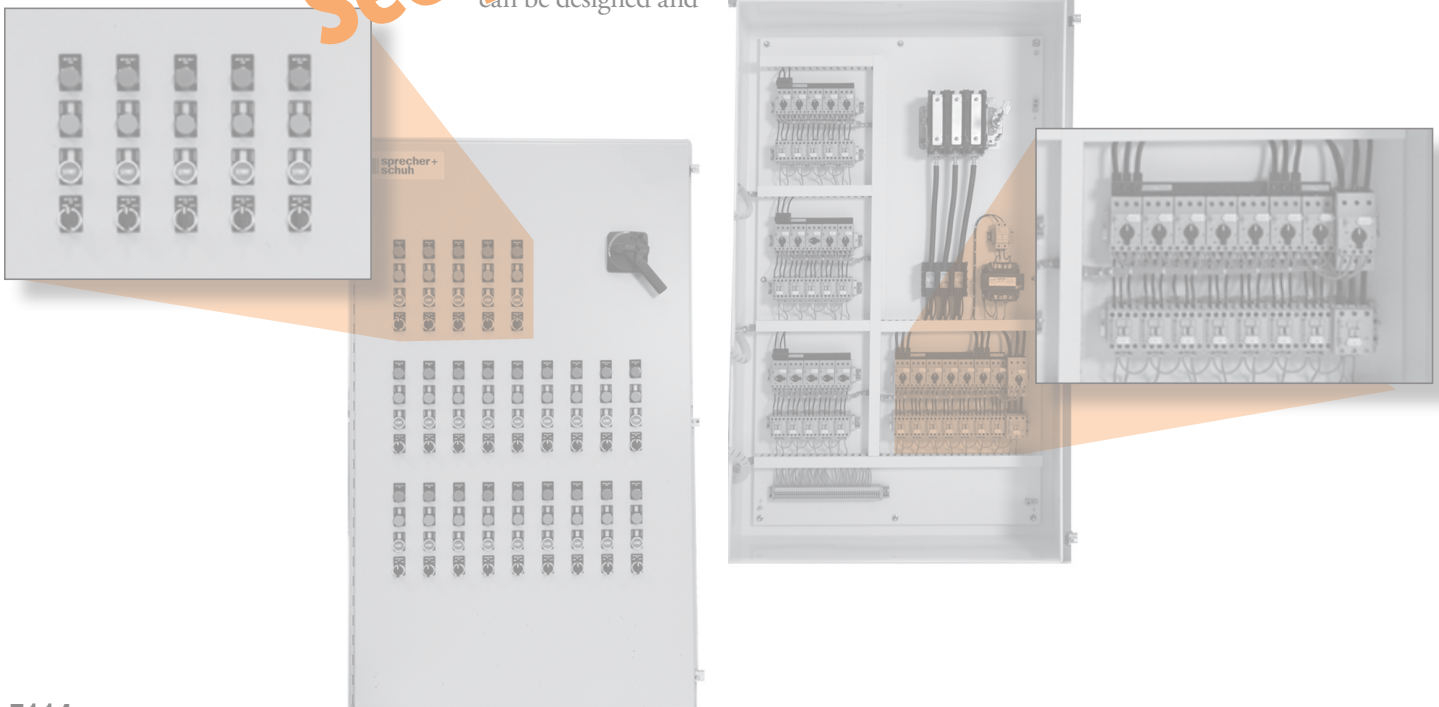

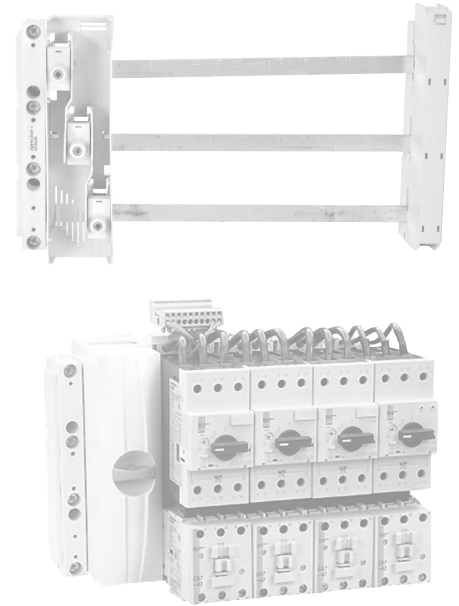
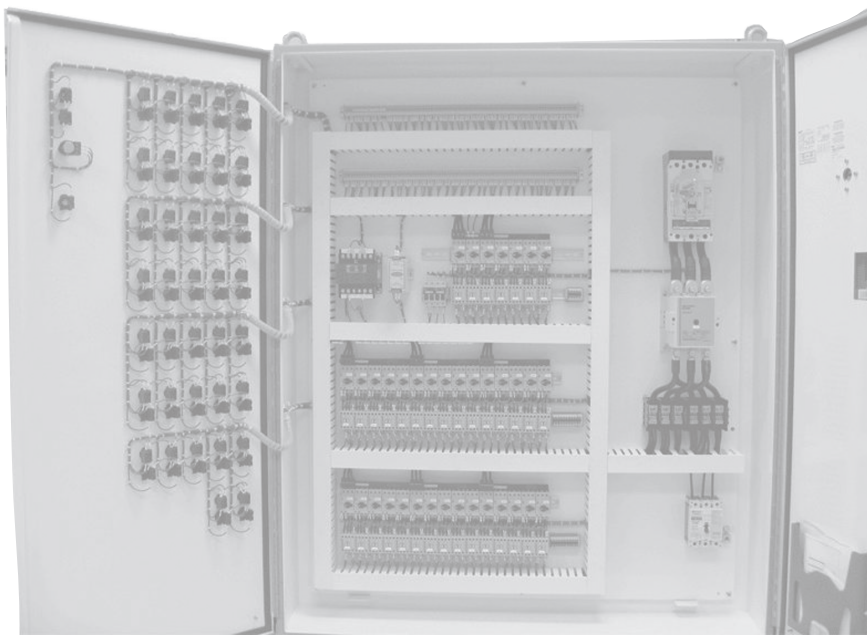

Short Circuit Current Ratings (SSCR)

Short Circuit Current Ratings as defined by UL is a hot topic of discussion within the controls marketplace.

UL 508A Industrial Control Panel specifications require every multiple motor starter panel assembly to be labeled with the Short-Circuit Current Rating (SCCR), which depends on the weakest component's KAIC rating. The SCCR rules are complicated and UL conducts classes around the country on this subject. Sprecher + Schuh conducted a survey of multi-starter panel builders which indicated an increased

concern on the part of panel builders to comply with the UL regulations; yet many do not truly understand the complexity of the rules. This is one reason to consult the experts at Sprecher + Schuh.

Section Obsolete
See pages F1.56 - F1.88

Custom Bus Bar Systems

Sprecher + Schuh has teamed-up with *Wöhner* to supply 3-phase 60 mm bus bar systems. Bus Bar systems offer more flexibility, and a smaller, more economic alternative to a Motor Control Center that uses 'bucket' design.

- Sprecher + Schuh can supply 3-phase 60 mm bus bar components for customer assembly into a control panel.
- We can help design a 3-phase 60 mm bus bar system and provide it with or without components and ship to the customer as open assembly.
- Sprecher + Schuh can help design a 3-phase 60 mm bus bar system and integrate that bus system into an enclosed assembly or multi-starter custom control panel to meet customers' unique specifications.

Please contact your local Sprecher + Schuh Representative or our Technical Support Team to help design our components to meet your needs, which can include building the custom control.



3-Phase 60mm Bus Bar System vertically arranged to maximize space

Single, Two and Three Phase Connection Diagram

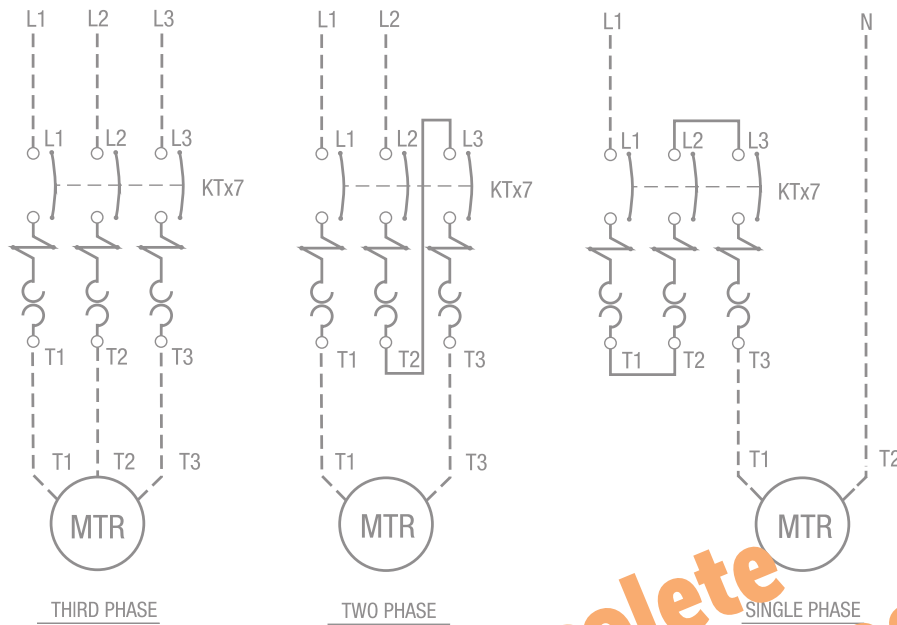

Type E/F Combination Controller, Full Voltage Non-Reversing AC Controller, Drives Pilot Devices

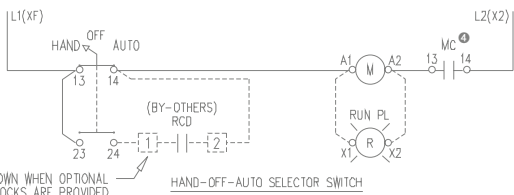
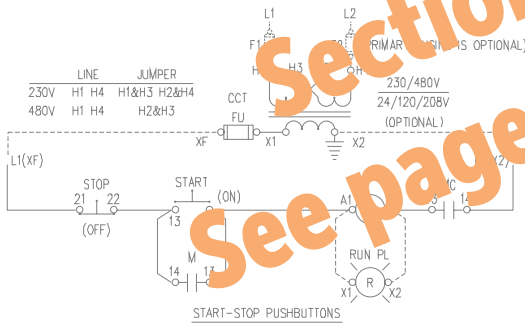

WIRE AS SHOWN WHEN OPTIONAL TERMINAL BLOCKS ARE PROVIDED

HAND-OFF-AUTO SELECTOR SWITCH

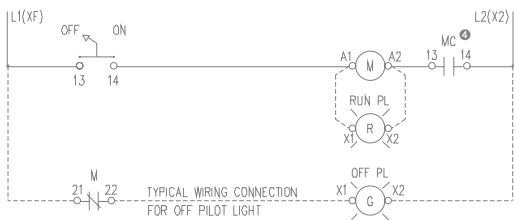

OFF-ON SELECTOR SWITCH

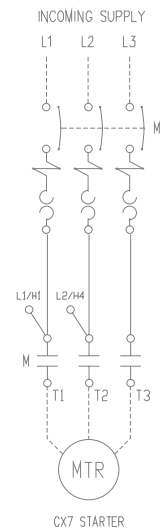

CX7 STARTER

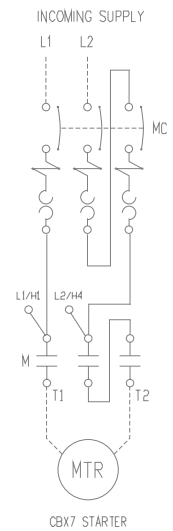

CBX7 STARTER

NOTES:

- 1) RCD: STANDS FOR REMOTE CONTROL DEVICE BY CUSTOMER
- 2) MC: KT7 "TYPE E" MOTOR CONTROLLER
- 3) X2 TERMINAL GROUNDED AS STANDARD, REMOVE GROUND IF NOT REQUIRED
- 4) TYPICAL FOR CONTROL CIRCUITS 300V AC OR LESS

F

Enclosed Motor Circuit Controllers

Section Obsolete
See pages F1.56 - F1.88

KTA7 Type E/F Combination 3-PH FVNR Duplex Alternating Panel with H-O-A, Lead, Lag and Stop 1-Pole Float Switches

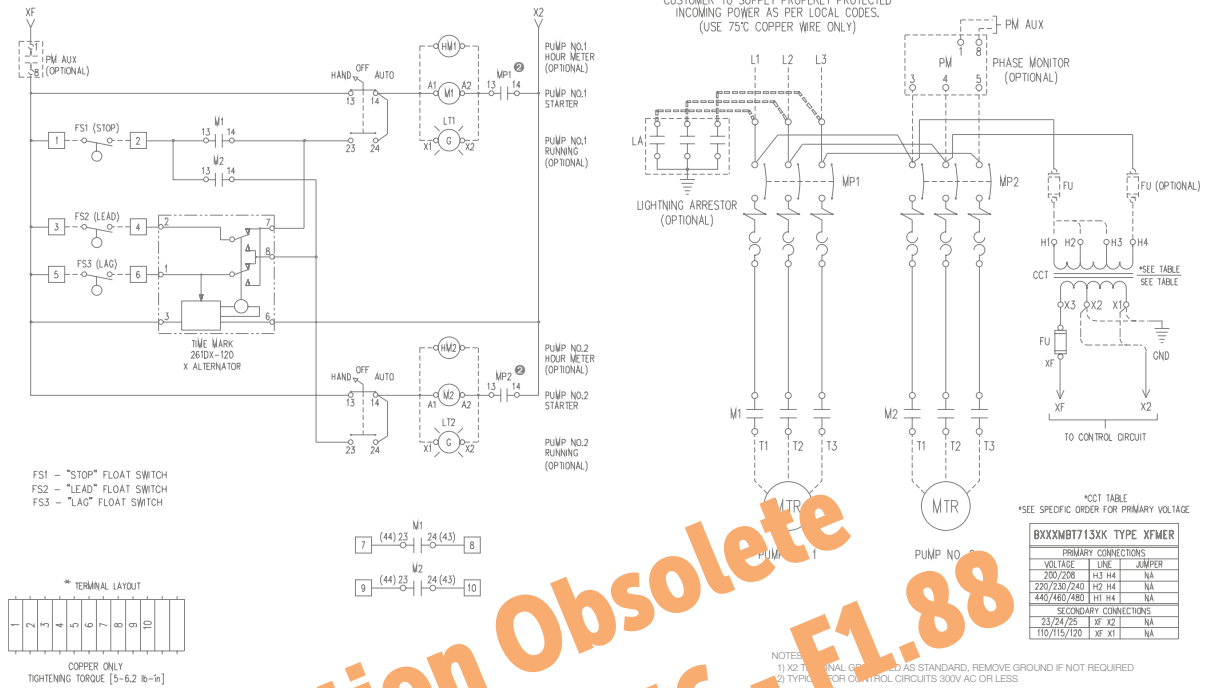

Section Obsolete
See pages F1.56 - F1.88

KTA7 Type E/F Combination 3-PH FVNR Duplex Alternating Panel with H-O-A, Alarm Circuit, Lead, Lag, Stop, 1-Pole Float Switches

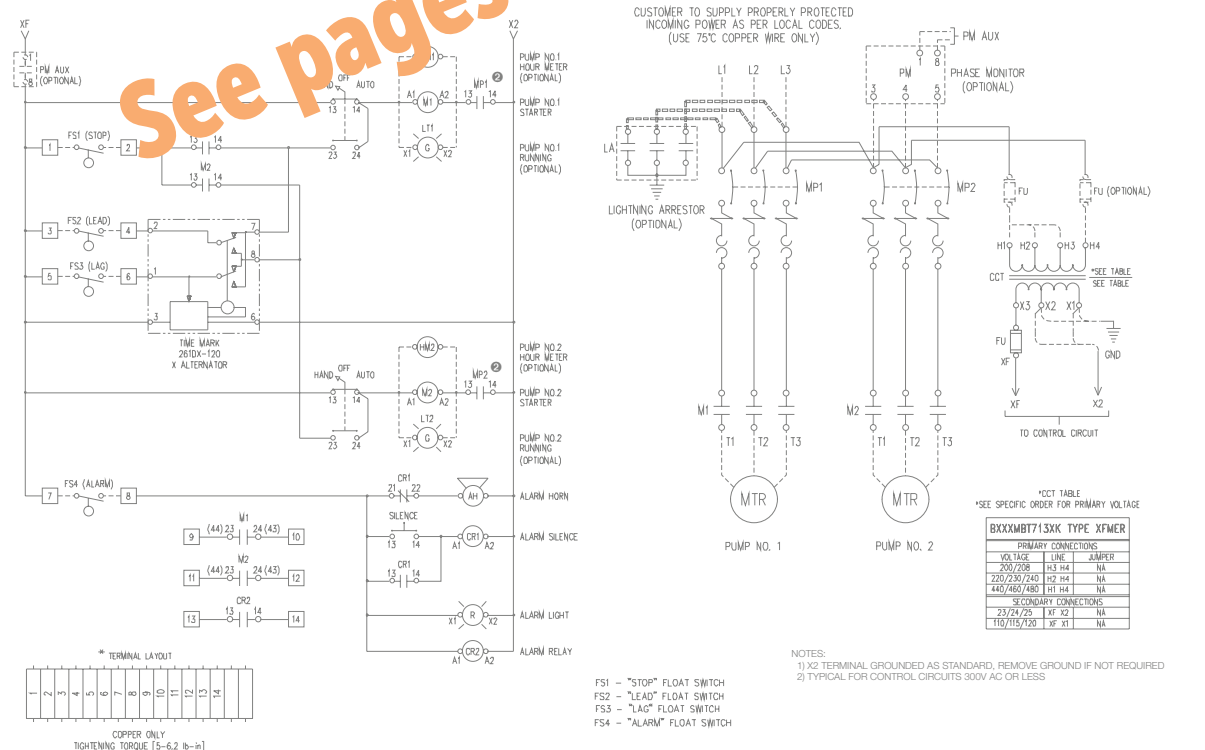

F
Enclosed Motor Circuit Controllers

ECombo/EComboPlus/CX7 KWIKstarters Non-Reversing

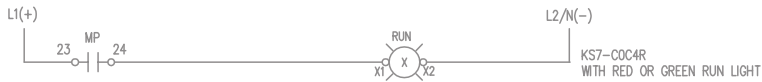
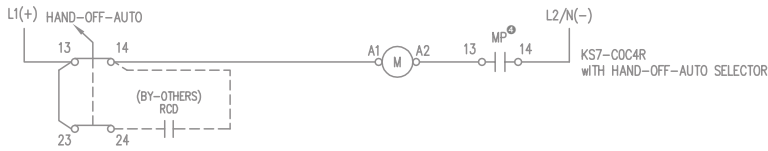
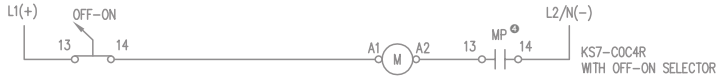
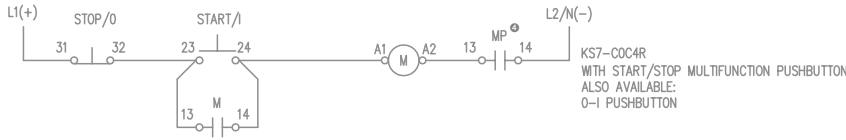

CUSTOMER TO SUPPLY PROPER BRANCH CIRCUIT PROTECTION AS PER LOCAL CODES. (USE 75°C COPPER WIRE ONLY)

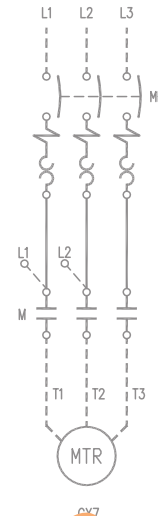

- NOTES:
- 1) MP: KT7 "TYPE E" MOTOR CONTROLLER
 - 2) DO NOT CONNECT A1-A2 TO L1-L2 UNLESS COIL VOLTAGE MATCHES LINE VOLTAGE
 - 3) OPTIONAL RUN LIGHT MAY BE RED OR GREEN
 - 4) TYPICAL FOR CONTROL CIRCUITS 300V AC OR LESS

ECombo/EComboPlus/CX7 KWIKstarters Reversing

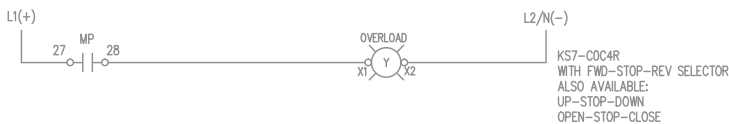
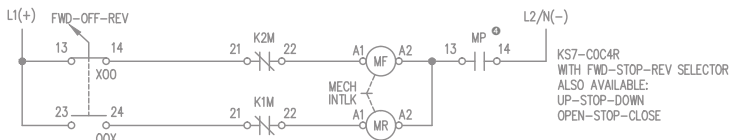
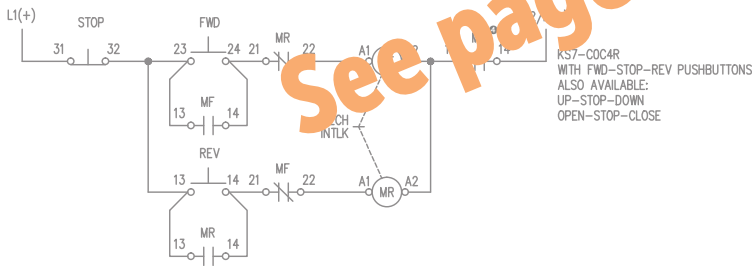

CUSTOMER WILL PROVIDE BRANCH CIRCUIT PROTECTION (F1) SEE THE APPLICATION INSTRUCTION SHEET - COMPONENT SELECTION TABLES FOR MAX. FUSE SIZE, CLASS, AND APPLICABLE SHORT CIRCUIT RATING (USE 75°C COPPER WIRE ONLY)

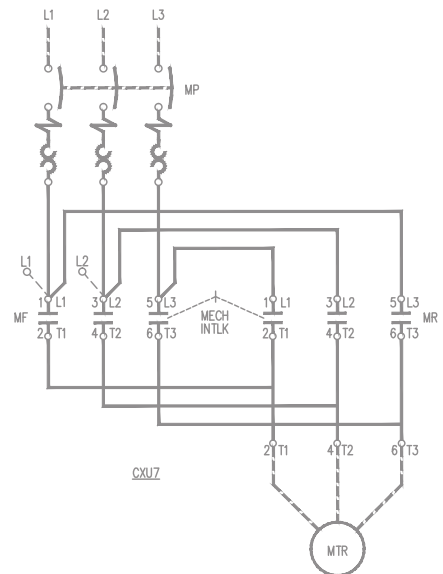

- NOTES:
- 1) MECHANICAL INTERLOCK
 - 2) MP: KT7 "TYPE E" MOTOR CONTROLLER
 - 3) DO NOT CONNECT A1-A2 TO L1-L2 UNLESS COIL VOLTAGE MATCHES LINE VOLTAGE
 - 4) TYPICAL FOR CONTROL CIRCUITS 300V AC OR LESS

F

Enclosed Motor Circuit Controllers

Section Obsolete See pages F1.56 - F1.88

CX7/CXU7 KWIKstarter Enclosure KS7-COC4R (Dimension Code Q4)

Dimensions are in decimal inches. Dimensions not intended for manufacturing purposes.

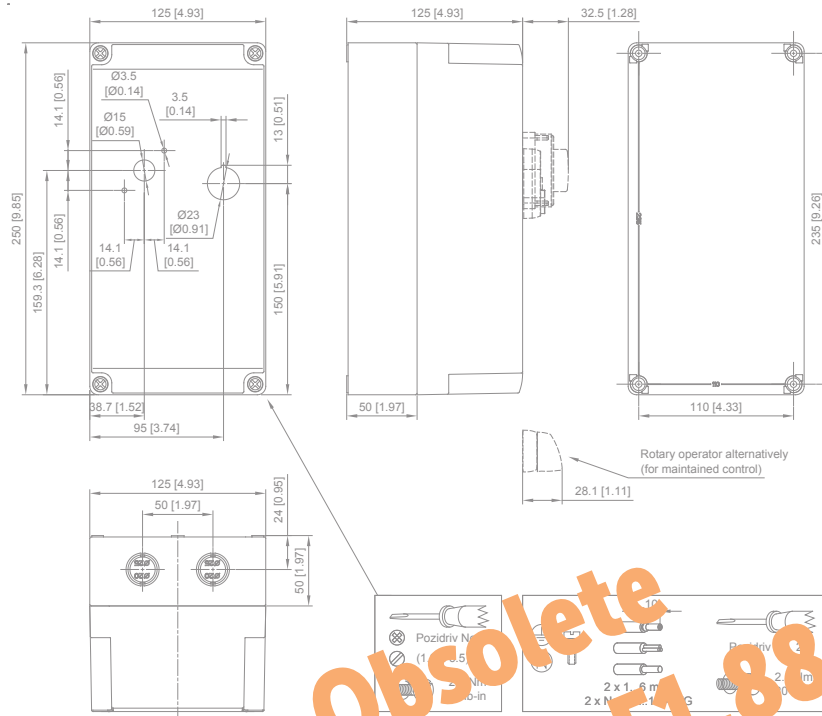

Section Obsolete
See pages F1.56 - F1.88

Enclosure Dimensions

Dimensions are in decimal inches. Dimensions not intended for manufacturing purposes. See dimension drawings on next page.

IP65 ENCLOSURE

Encl. ID Dim.	Figure No.	Enclosure Size			Mtg Depth	Mtg Centers			Panel Size Sub-Pan	
		A	B	C		D	E	F		
AY	1	5.9	9.4	5.12	N/A	N/A	5.32	N/A	N/A	

TYPE-4/4X/12 ENCLOSURE

Encl. ID Dim.	Figure No.	Enclosure Size			Mtg Depth	Mtg Centers			Panel Size Sub-Pan	
		A	B	C		D	E	F		
Q5	2	7.00	5.03	5.02	4.3	4.21	6.18	N/A	N/A	
Q6	3	7.00	7.00	6.02	5.3	6.18	6.18	N/A	N/A	
Q7	4	11.87	7.31	10.6	7.23	6.54	11.10	N/A	N/A	

TYPE-4/12 & 12 ENCLOSURES

Encl. ID Dim.	Figure No.	Enclosure Size			Mtg Depth	Mtg Centers			Panel Size Sub-Pan		H
		A	B	C		D	E	F			
W6	5	9.84	7.87	8.24	5.31	5.31	9.13	9.09	7.13	-	
W7	5	13.78	11.81	10.2	7.28	9.25	13.07	13.03	11.06	-	
L	6	8	6	6	5.53	4	8.75	6.75	4.88	9.5	

TYPE 4/7/9 ENCLOSURES

Encl. ID Dim.	Figure No.	Mtg. Dim.			Inside Dim.	Outside Dim.				Conduit Entry Top & Bot
		A	B	C		D	E	F	G	
EX	7	3.25	7.75	3.5	6.0	3.0	4.56	7.06	6.25	0.75
EY	7	5.50	8.50	5.50	5.50	6.0	7.0	7.0	8.84	1.0
EZ	8	9.13	4.50	6.0	8.0	6.63	9.25	11.25	9.34	1.50

Enclosures

See Enclosure Dimension Charts on Previous Page.

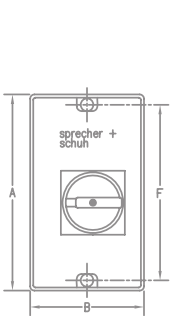

FIGURE NO. 1

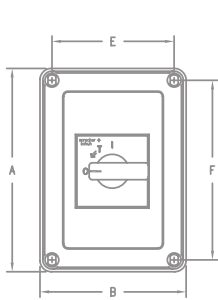

FIGURE NO. 2

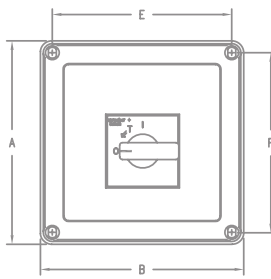

FIGURE NO. 3

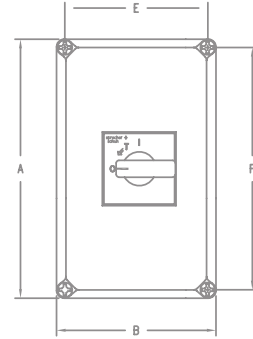
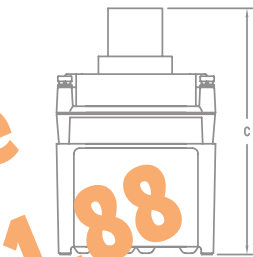
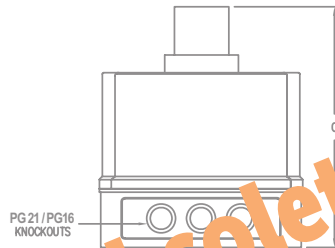
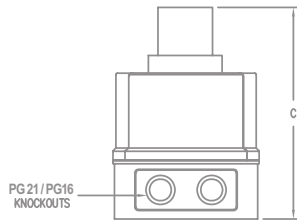
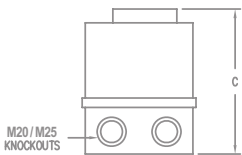
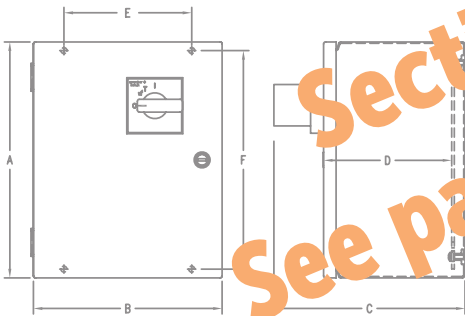

FIGURE NO. 4



Section Obsolete
See pages F1.56 - F1.88



TYPE 4/12
FIGURE NO. 5

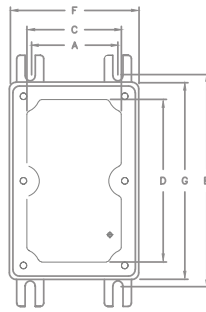

FIGURE NO. 7

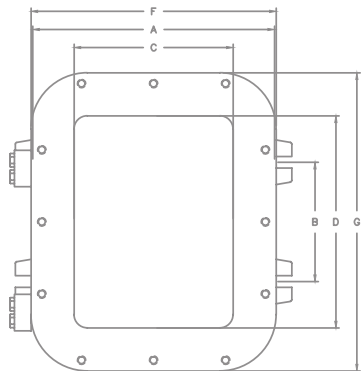
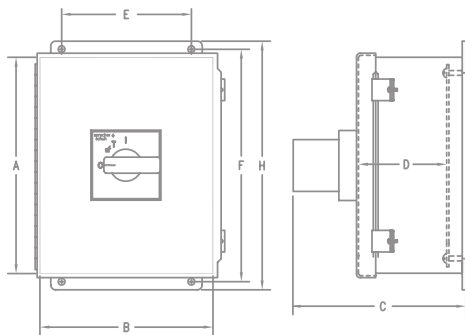
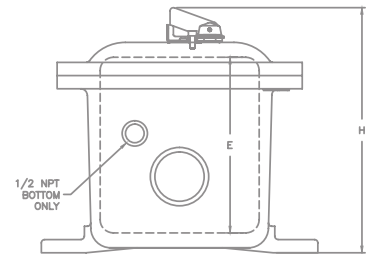
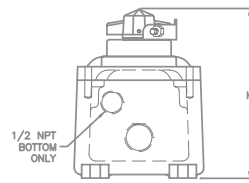

FIGURE NO. 8



TYPE 12
FIGURE NO. 6



F
Enclosed Motor Circuit Controllers

KT4 Manual Motor Starter

DISCONTINUED



Ideal for use as a manual starter

The KT4 is a manual motor starter that employs the features of power switching, thermal overload protection and control circuit signaling in one compact unit. This manual motor starter has the advantage of a high speed magnetic trip mechanism which limits the let-through current under short-circuit conditions. The KT4 can be supplied with field installable shunt trip or an under voltage trip unit which exceeds the capabilities of the classic manual motor starter. This manual motor starter is available in a variety of enclosures including general purpose, watertight and explosion proof (the most compact on the market today).

KT4 Reduces panel space and saves money in Group Motor Installations

The KT4 can eliminate the need for larger and more expensive fuse blocks and fused disconnects, or circuit breakers. The potential cost savings in group motor installations according to NEC 430-53c can be as much as 35% over conventional methods of branch circuit protection. And, because so many features are combined into one small unit, panel space can be slashed by as much as 60%.

In addition, the KT4 line offers a wide application range from 0.1 to 16 FLA in installations up to 600V. For group motor applications, the KT4 series has a 250A group installation rating, with a withstand rating as high as 42 KAIC.



Excellent short circuit and thermal overload protection

In the event of a short-circuit, the contacts are opened by magnetic, non-adjusting tripping elements in times approaching 2/1000 of a second. This results in the extremely rapid build-up of an arc voltage which limits the current of the short-circuit to a very low level. Because of this superb current limiting capability the let-through current is significantly reduced and the potential for damage is limited.

Because each KT4 is individually calibrated at the factory for the smallest and largest current, very accurate thermal overload protection is also obtained. In addition, the KT4 is a Class 10 device ... it trips within 10 seconds under a locked rotor condition (6 x FLA). Every KT4 Manual Motor Starter is equipped with automatic ambient temperature compensation, which continually adjusts to surrounding temperatures. As a result, trip times remain constant and accurate.

Accessories add versatility

Whether in group motor installations or as a manual motor starter, numerous field installable accessories are available to enhance the KT4's performance:

- **Auxiliary Contact Blocks** – are available for internal or external mounting providing signal switching capability for control circuits.
- **Shunt trip and Undervoltage Release Modules** – provides the ability to remotely actuate the KT4 in emergency situations or continuously monitor the line voltage.
- **Enclosures** – are available in general protection (IP41), or watertight (IP55), complete with lockable accessories.
- **Compact Bus Bar System** – reduces the task of line side wiring in multiple motor starter installations which reduces the labor cost of installation.

F

KT4 Manual Motor Starters

KT4 Manual Motor Starter ①

Maximum Horsepower ①②						O/L Relay Ampere Response ④	Magnetic Response Current	Ordering Information ①
Single Ø ②		Three Ø						Catalog Number
115V	230V	200V	230V	460V	575V			
~	~	~	~	~	~	0.1 - 0.16	1.8	KT4-C2A-A16
~	~	~	~	~	~	0.16 - 0.25	2.8	KT4-C2A-A25
~	~	~	~	~	~	0.25 - 0.4	4.4	KT4-C2A-A40
~	~	~	~	~	~	0.4 - 0.63	6.9	KT4-C2A-A63
~	~	~	~	~	1/2	0.63 - 1.0	11	KT4-C2A-B10
~	1/10	~	~	1/2	3/4	1.0 - 1.6	18	KT4-C2A-B16
1/10	1/6	1/2	1/2	1	1-1/2	1.6 - 2.5	28	KT4-C2A-B25
1/8	1/3	3/4	3/4	2	3	2.5 - 4.0	44	KT4-C2A-B40
1/4	1/2	1	1-1/2	3	5	4.0 - 6.3	69	KT4-C2A-B63
1/2	1-1/2	2	3	5	7-1/2	6.3 - 10	110	KT4-C2A-C10
1	2	3	5	10	10	10 - 16	176	KT4-C2A-C16

F

KT4 Manual Motor Starters

Short Circuit Ratings ⑤

Catalog Number	Manual Motor Starter / Group Installation Ratings		
	Short Circuit Rating (kA)		Maximum Branch Circuit Protection Rating ⑤
	480V	600V	Amperes
KT4-C2A-A16	42	42	250
KT4-C2A-A25	42	42	250
KT4-C2A-A40	42	42	250
KT4-C2A-A63	42	42	250
KT4-C2A-B10	42	42	250
KT4-C2A-B16	42	42	250
KT4-C2A-B25	42	10	250
KT4-C2A-B40	18	5	250
KT4-C2A-B63	18	5	250
KT4-C2A-C10	10	5	250
KT4-C2A-C16	10	5	250

① Horsepower ratings shown are the maximum rating of the switching capacity of the main contactors. **The final selection of the manual starter depends on the actual motor full load amps and service factor.**

Example #1:

For a motor with a service factor of 1.15 or greater, use the motor nameplate full load amps and choose the motor starter with the appropriate current range.

Motor F.L.A. 4.2A
Service Factor 1.15

Select catalog number **KT4-C2A-A63** (Range 4.0-6.3 Amps)

Example #2:





For a motor with a service factor less than 1.15, use the motor nameplate full load amps times 0.9 and choose the motor starter with the appropriate current range.



Motor F.L.A. 4.2A
Service Factor 1.0
Multiplier x 0.9
Effective Current = 3.78A

Select catalog number **KT4-C2A-A40** (Range 2.5-4.0 Amps)

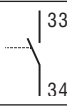
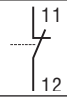
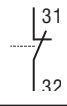
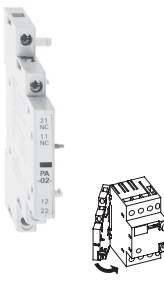

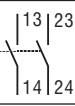
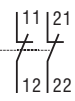
- ② Single phase horsepower ratings are based on wiring the 3 poles of the device in series.
- ③ The KT4 motor circuit controller is approved for use in group installation according to NEC 430-53C. Reference Sprecher+Schuh UL file #E54612.
- ④ The actual trip current is 120% of the dial setting.
- ⑤ Although UL Testing of Manual Motor Starters allows for Group Installation with upstream Branch Circuit Protection maximum ratings as high as 250 amperes; it should be noted that NEC 2002 contains new restrictions under NEC 430-53D "Single Motor Taps". KT4 should be applied as outlined in NEC 430-53D-1 or 430-53D-2 to be in compliance. KT4 does not qualify as "Tap Conductor Protection" as required under NEC 430-53D-3. Please refer to the Application notes located at the end of the KT7 section for more details on compliance.

Accessories for KT4

Accessory	Description	Wiring Diagram	Catalog Number
	Auxiliary Contact Block (NO) - mounts internally.		KT4-C-AEA10
	Auxiliary Contact Block (NO) - mounts internally, terminal markings appropriate when also using "PA" type auxiliary contact.		KT4-C-AEA210
	Auxiliary Contact Block (NC) - mounts internally.		KT4-C-AEA01
	Auxiliary Contact Block (NC) - mounts internally, terminal markings appropriate when also using "PA" type auxiliary contact.		KT4-C-AEA201
	Two pole Auxiliary Contact Block (NO/NC) - for side mounting. If using Compact Bus Bar System, choose bus bar with 54mm spacing		KT4-C-ASA11
	Two pole Auxiliary Contact Block (NO/NO) - for side mounting. If using Compact Bus Bar System, choose bus bar with 54mm spacing.		KT4-C-ASA20
	Two pole Auxiliary Contact Block (NC/NC) - for side mounting. If using Compact Bus Bar System, choose bus bar with 54mm spacing.		KT4-C-ASA02

Accessory	Description	Catalog Number
	Adaptor Plate Provides capability to base mount one KT4	KT4-C-N12
	Locking Fixture Padlocking attachment for one KT4-25. Locks in the OFF position only. Metal construction. Holds one to three padlocks with 6mm hasps.	KT4-C-M3

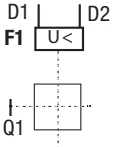
Accessories for KT4 (continued from previous page)

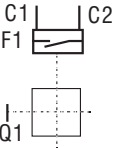



Accessory	Description	Wiring Diagram	AC Coil Voltage		Catalog Number
			50 HZ	60 HZ	
	Undervoltage Release Module - mounts on right hand side, Prevents KT4 from operating unless voltage is present.		24V	~	KT4-C-UXX
			~	24V	KT4-C-UXJ
			~	48V	KT4-C-UXX
			110V	110V	KT4-C-UXKD
			110V	120V	KT4-C-UXD
			220...230V	240...260V	KT4-C-UXF
			~	240...260V	KT4-C-UXA
			240V	277V	KT4-C-UXT
			400V	460V	KT4-C-UXN
			415V	480V	KT4-C-UXB
			500V	575V	KT4-C-UXM
				Shunt Release Module - mounts on right hand side. Remotely trips the KT4 .	
~	24V	KT4-C-SXJ			
~	48V	KT4-C-SXX			
110V	110V	KT4-C-SXKD			
110V	120V	KT4-C-SXD			
220...230V	240...260V	KT4-C-SXF			
~	240...260V	KT4-C-SXA			
240V	277V	KT4-C-SXT			
400V	460V	KT4-C-SXN			
415V	480V	KT4-C-SXB			
500V	575V	KT4-C-SXM			



F
KT4 Manual Motor Starters

Accessory	Description	Voltage / Rated Current	Catalog Number
	Connecting Module ①- Provides a solid "wireless" connection between a KT4 Motor Circuit Controller and a CA7 contactor. Connects CA7-9...23	20A	KT4-C-PNC23

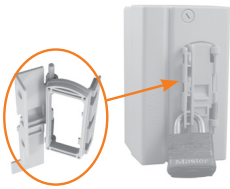
① cULus Approved (File E33916).



Accessories for KT4 (continued from previous page)

Accessory	Description	Enclosure Rating	Catalog No. ❶
 KT4-C-EA55	Enclosures for Surface Mounting - Includes ground and neutral terminals.	General Purpose (IP41)	KT4-C-EA41
		Watertight (IP55)	KT4-C-EA55
 KT4-C-EE55	Enclosure for Flush Mounting - includes protective earth and neutral wire terminals.	General Purpose (IP41)	KT4-C-EE41
		Watertight (IP55)	KT4-C-EE55
	Enclosure Locking Fixture - Holds one to three padlocks with 6mm hasps.	For use with KT4-C-EA41 and KT4-C-EA55 enclosures	KT4-C-M3E
	Enclosure Membrane - Replacement membrane. Includes 4 mounting screws (membrane only, does not include mounting frame).	For replacement on KT4-C-EA55 or -EE55 or to upgrade KT4-C-EA41 or -EE41 enclosures	KT4-C-N55

Accessory	Description	Kit Catalog No.	For Use With	Assembled Cat No. ❶
 KT4-C-MT-EA55	Emergency Stop Kit Twist-To-Release	KT4-C-MT	KT4-C-EA41	KT4-C-MT-EA41
			KT4-C-EE41	KT4-C-MT-EE41
			KT4-C-EA55	KT4-C-MT-EA55
			KT4-C-EE55	KT4-C-MT-EE55
 KT4-C-MK-EA55	Emergency Stop Kit Key Release	KT4-C-MK	KT4-C-EA41	KT4-C-MK-EA41
			KT4-C-EE41	KT4-C-MK-EE41
			KT4-C-EA55	KT4-C-MK-EA55
			KT4-C-EE55	KT4-C-MK-EE55

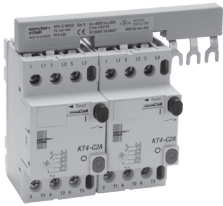
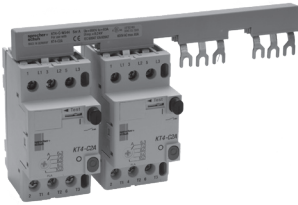
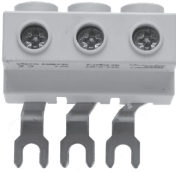

❶ KT4 Manual Motor Starter Not Included. Consult a Sprecher + Schuh representative for an assembly including a KT4.

Compact Bus Bar System for KT4

Accessory	Description	Catalog Number
	<p>Compact Bus Bar - 45mm spacing - Bus bar with 45mm spacing accepts KT4's with <i>or without</i> internally mounted auxiliary or trip signal contact. Rated to 65A (UL)/63A (IEC).</p> <p>Connects two KT4's Connects three KT4's Connects four KT4's Connects five KT4's</p>	<p>KT4-C-W452 KT4-C-W453 KT4-C-W454 KT4-C-W455</p>
	<p>Compact Bus Bar - 54mm spacing - Bus bar with 54mm spacing accepts KT4's with side mounted auxiliary contact (type PA-11). Rated to 65A (UL)/63A (IEC).</p> <p>Connects two KT4's Connects three KT4's Connects four KT4's Connects five KT4's</p>	<p>KT4-C-W542 KT4-C-W543 KT4-C-W544 KT4-C-W545</p>
	<p>Supply Block - Provides connection from bus bar to power.</p>	<p>KT4-C-WT</p>
	<p>Blank Space Cover - Covers bus bar connections where no KT4 is mounted.</p>	<p>KT4-C-WS</p>

F
KT4 Manual Motor Starters

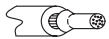
Technical Information

Standards Approvals	KT4... UL 508; CSA22.2; EN/IEC 60947-1/-2/-4/-5-1/ UL, CSA, CE, SEV, Germ. Lloyd, CEBC, PTB, DEMKO, SEMKO, SETI, NEMKO, Bureau Veritas, Lloyd's Register of Shipping, Maritime Register of Shipping, RINA, KEMA	
Approvals / Markings	CE, cULus Listed	
Rated Insulation Voltage		
IEC, SEV, VDE0660 [V]		690
UL, CSA [V]		600
Rated Impulse Withstand Voltage		
Main circuits		6 kV
Auxiliary circuits		6 kV
Rated Frequency [Hz]		40...60
Rated Operating Current [A]		0.1...16 (11 ranges)
Life		
Mechanical [operations]		100,000
Electrical [operations]		50,000
Switching Frequency		Max. 30 operating cycles/hour
Ambient Temperature		
Storage		-25°C to +80°C
Operation		-25°C to +60°C
Resistance to climatic change		
Humid heat		40°C, 92%, 56 days
Alternating climatic conditions		23°C, 83%/40°C, 93%, 56 cycles
Degree of Protection		IP20 (when wired)
Impact Resistance (shock)		50g, 11ms
Vibration Strength		
Frequency Range		10...150Hz
In all directions		>7.5g
Overload Protection		
Tripping Time		Class 10
Phase failure protection		See time/current curve
Temperature Compensation		-20°C... +60°C (70°C=15% current reduction of upper rated current)
Magnetic Response		11 x I _e max. (fixed setting) (I _e max. = max value of the setting range)
Total Power dissipation		
Manual motor starter at rated load [W]		7
Terminal Connections		
Type of terminals		
Screwdriver		Position No. 2/Blade No. 3
	1. conductor	1 to 4 mm ² / 16 to 12 AWG
	2. conductor	1 to 4 mm ² / 16 to 12 AWG
	1. conductor	1 to 6 mm ² / 16 to 12 AWG
	2. conductor	1 to 6 mm ² / 16 to 12 AWG
	1. conductor	1.5 to 6 mm ² / 16 to 12 AWG
	2. conductor	1.5 to 6 mm ² / 16 to 12 AWG
Tightening torque		2 to 2.5 Nm / 18 to 22 lb-in



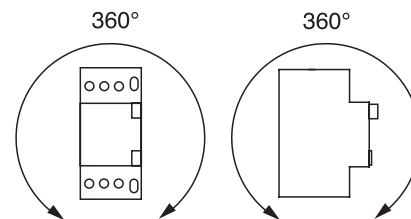

Mounting Position - KT4





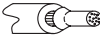

Weights

Description	Catalog Number	Weight
Manual Motor Starter	KT4-C2A...	290 g
Auxiliary Contact Blocks for Flush Mounting	KT4-C-AEA	12 g
Auxiliary Contact Blocks for Left-side Mounting	KT4-C-ASA	35 g
Undervoltage Release	KT4-C-UX	104 g
Shunt Release	KT4-C-SX	100 g
Bus Bar Feeder Terminal	KT4-C-WT	36 g
Compact Bus Bar	KT4-C-W452	42 g
	KT4-C-W453	69 g
	KT4-C-W454	94 g
	KT4-C-W455	119 g
	KT4-C-W542	45 g
	KT4-C-W543	76 g
KT4-C-W545	104 g	
KT4-C-W545	135 g	
Blank Space Cover	KT4-C-WS	3.3 g
Emergency-Stop Push Button	KT4-C-MT	g
	KT4-C-MK	g
Enclosure for Surface Mounting	KT4-C-EA41	250 g
Enclosure for Flush Mounting	KT4-C-EA55	258 g
Button Membrane	KT4-C-EE41	126 g
	KT4-C-EE55	134 g
Indicator Light	KT4-L...	10 g
Hut (DIN) rail Adapter	KT4-C-N12	16 g
	KT4-C-M3E	19 g
Locking Arrangement	KT4-C-M3	11 g

Technical Information

Specifications of Accessories		KT4-C-AEA... Auxiliary Contact Block for Flush Mounting				KT4-C-ASA... Auxiliary Contact Block for Left-side Mounting			
Rated Thermal Current / _{th} at 40°C ambient temperature [A] at 60°C ambient temperature [A]		6				10			
		4				6			
Contact Class Coordination According to NEMA (UL/CSA Standards)		B 600 Standard Pilot Duty R 300 Light Pilot Duty				B 600 Standard Pilot Duty R 300 Light Pilot Duty			
Back-Up Fuses gG, gL	[A]	16				16			
Rated Supply current	[V]	230/240	400/415	500	690	230/240	400/415	500	690
	AC-15 [A]	2	1	0.8	0.5	2	1	0.8	0.5
	DC-13 [V]	24	48	110	220	24	48	110	220
	[A]	2	0.6	0.2	0.1	2	0.6	0.2	0.1
Terminal Parts									
Type of terminals									
Screwdriver		Pozidrive No. 2 / Blade No. 3 							
	1. conductor	0.75 to 2.5 mm ² / 18 to 14 AWG				0.75 to 2.5 mm ² / 18 to 14 AWG			
	2. conductor	0.75 to 2.5 mm ² / 18 to 14 AWG				0.75 to 2.5 mm ² / 18 to 14 AWG			
	1. conductor	0.75 to 4 mm ² / 18 to 14 AWG				0.75 to 4 mm ² / 18 to 14 AWG			
	2. conductor	0.75 to 4 mm ² / 18 to 14 AWG				0.75 to 4 mm ² / 18 to 14 AWG			
	1. conductor	0.75 to 4 mm ² / 18 to 14 AWG				0.75 to 4 mm ² / 18 to 14 AWG			
	2. conductor	0.75 to 4 mm ² / 18 to 14 AWG				0.75 to 4 mm ² / 18 to 14 AWG			
Tightening torque		1 to 1.5 Nm / 9 to 13 lb-in				1 to 1.5 Nm / 9 to 13 lb-in			

		KT4-C-UX... Undervoltage Release Unit for Right-side Mounting	KT4-C-SX... Shunt Release for Right-side Mounting	KT4-C-WT Supply Block
Actuating Voltage	Pull-in	0.8 to 1.1 x U _s	0.7 to 1.1 x U _s	
	Drop-out	0.7 to 0.35 x U _s	~	
Rated Control Voltage	min.	12V 50 Hz, 14V 60 Hz	12V 50 Hz, 14V 60 Hz	
	max.	600V 50 Hz	600V 50 Hz	
On-Time		100 %	100 %	
Coil Rating	Pull-in	8.5 VA, 6 W	8.5 VA, 6 W	
	Hold	3 VA, 1.2 W	3 VA, 1.2 W	
Terminal Parts				
Type of terminals				
Screwdriver		Pozidrive No. 2/Blade No. 3 		
	1. conductor	0.75 to 2.5 mm ² / 18 to 14 AWG	0.75 to 2.5 mm ² / 18 to 14 AWG	4 to 16 mm ² / 14 to 6 AWG
	2. conductor	0.75 to 2.5 mm ² / 18 to 14 AWG	0.75 to 2.5 mm ² / 18 to 14 AWG	4 to 16 mm ² / 14 to 6 AWG
	1. conductor	0.75 to 4 mm ² / 18 to 14 AWG	0.75 to 4 mm ² / 18 to 14 AWG	4 to 16 mm ² / 14 to 6 AWG
	2. conductor	0.75 to 4 mm ² / 18 to 14 AWG	0.75 to 4 mm ² / 18 to 14 AWG	4 to 16 mm ² / 14 to 6 AWG
	1. conductor	0.75 to 4 mm ² / 18 to 14 AWG	0.75 to 4 mm ² / 18 to 14 AWG	4 to 16 mm ² / 14 to 6 AWG
	2. conductor	0.75 to 4 mm ² / 18 to 14 AWG	0.75 to 4 mm ² / 18 to 14 AWG	4 to 16 mm ² / 14 to 6 AWG
Tightening torque		1 to 1.5 Nm / 9 to 13 lb-in	1 to 1.5 Nm / 9 to 13 lb-in	4 Nm / 36 lb-in

		KT4-C-W45... Compact Bus Bar	KT4-C-W54... Compact Bus Bar
Rated Insulation Voltage U _i	[V]	690	690
Rated Thermal Current I _{th}	[A]	63	63

		KT4-C-EA41 / -EE41 Enclosure	KT4-C-EA55 / -EE55 Enclosure	KT4-C-L... Indicator Light
IP Protection		IP41	IP55 (with seal and protective membrane)	IP54
Ambient Temperature	[°C]	- 25...+ 40	- 25...+ 40	~
Rated Operating Voltage	[V]	~	~	120, 240, 415, 480

IEC Performance Data (KT4-C2A)

		-A16	-A25	-A40	-A63	-B10	-B16	-B25	-B40	-B63	-C10	-C16
Switching of standard three phase motors												
AC-2, AC-3												
230/240V	[kW]	~	~	~	0.06/0.09	0.12	0.18/0.25	0.37	0.55/0.75	1.1/1.5	2.2	3.0/4.0
400/415V	[kW]	0.02	0.06	0.09	0.18/.25	0.25	0.37/0.55	.75	1.1/1.5	2.2	3.0/4.0	5.5/7.5
500V	[kW]	~	~	~	0.18	0.25/0.37	0.55/0.75	1.1	1.5/2.2	2.5/3.0	4.0/6.3	7.5/10
690V	[kW]	~	~	~	0.25	0.37/0.55	0.75/1.1	1.8	2.2/3.0	~	~	~
Back-up fuses												
gG, aM, only if $I_{cc} > I_{cu}$												
230/240V	[A]	No Fuses Required						~	~	~	~	50
400/415V	[A]							~	~	~	63	50
500V	[A]							~	~	63	50	50
690V	[A]							25	35	~	~	~
Ultimate short-circuit breaking capacity I_{cu}												
230/240V	[kA]	65	65	65	65	65	65	50	50	50	50	3
400/415V	[kA]	65	65	65	65	65	65	50	10	10	8	6
500V	[kA]	50	50	50	50	50	50	50	3	10	4.5	4.5
690V	[kA]	50	50	50	50	50	50	4.5	2	~	~	~

CSA Performance Data (KT4-C2A)

		-A16	-A25	-A40	-A63	-B10	-B16	-B25	-B40	-B63	-C10	-C16
Maximum short-circuit current												
480V	[kA]	42	42	42	42	42	42	42	18	18	10	5
600V	[kA]	42	42	42	42	42	42	10	5	5	5	5
Motor load												
1-phase												
115V	[HP]	~	~	~	~	~	~	1/10	1/8	1/4	1/2	1
230V	[HP]	~	~	~	~	~	1/10	1/6	1/3	3/4	1 1/2	3
3-phase												
200V	[HP]	~	~	~	~	~	~	1/2	3/4	1 1/2	2	3
230V	[HP]	~	~	~	~	~	~	3/4	1	2	3	5
460V	[HP]	~	~	~	~	1/2	1	1 1/2	3	5	7 1/2	10
575V	[HP]	~	~	~	~	3/4	1	2	3	5	10	15

Auxiliary Contact & Trip Indicator Contact Development ①

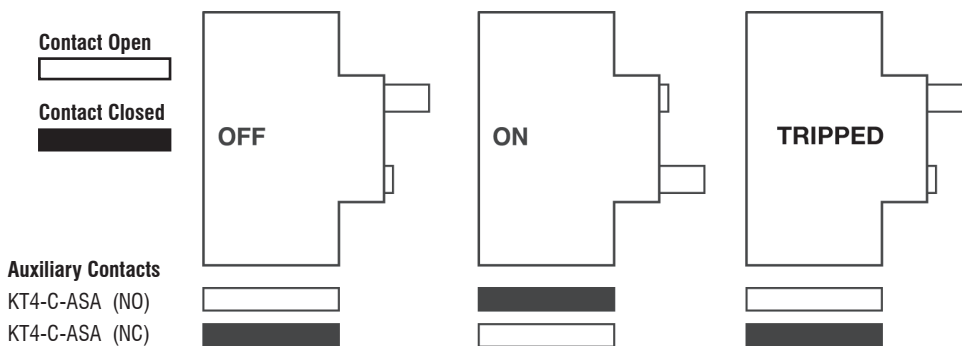

① KT4 leaves the factory in the Auto Reset mode. This means the Off and Trip positions are the same. If a true trip position is required, consult your Sprecher + Schuh representative.

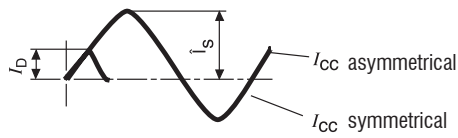

The KT4-C2A manual motor starter limits short-circuit current I_{cc} (prospective short-circuit current). I_D is the maximum cut-off current (highest instantaneous value of the limited short-circuit current). This value is indicated in the following diagram as a function of the system short-circuit current.

Correspondingly the maximum forward $i^2 dt$ energy is limited. This value is indicated in the following diagram as a function of the system short-circuited current.

KT4-C2A
Max. Let-Through (cut-off) Current, $U_e = 400...415V$

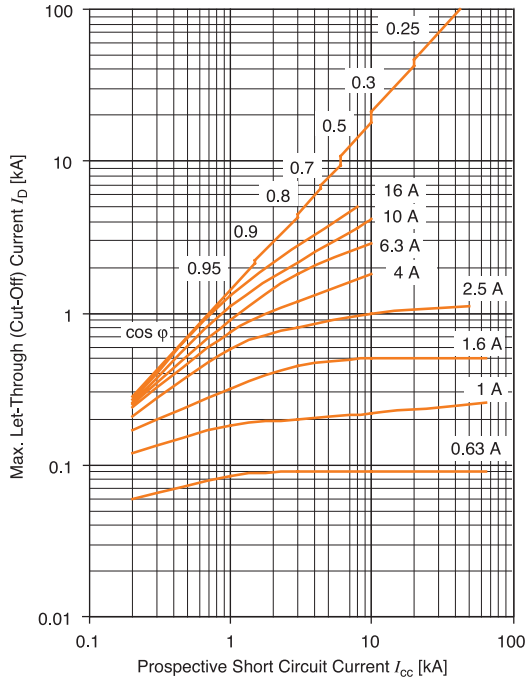

KT4-C2A
Max. Let-Through Energy, $U_e = 400...415V$

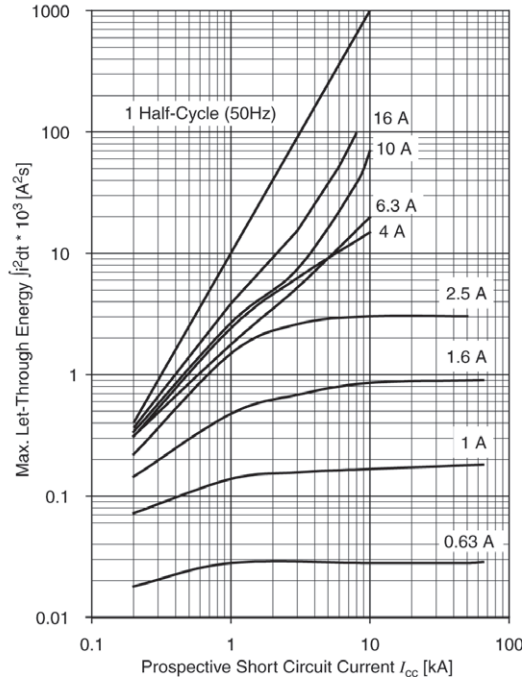

KT4-C2A
Time / current characteristics

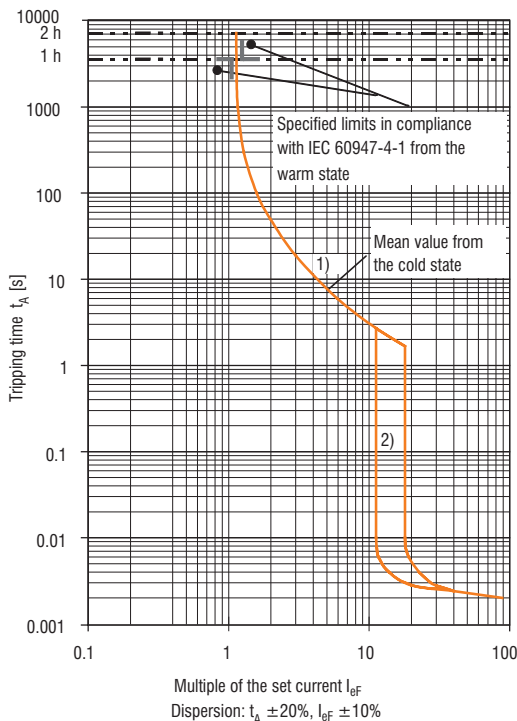

1) Operating Current of Thermal Releases:

The adjustable inverse bimetal trip reliability protects motors against overloads. The curve shows the mean operating current at an ambient temperature of 20°C starting from cold.

In equipment at operating temperature, release time is less than or equal to release time from the cold state.

2) Operating Current of Magnetic Releases:

Electromagnetic instantaneous releases react at a fixed tripping current.

At the upper thermal release setting, this tripping current is 11 times the set current.

Current To Be Set:

Thermal releases meet the requirements for a thermal release of a starter in accordance with IEC 60947-4-1 f. If a different value is specified (such as reduced I_e in motors with an ambient temperature higher than 40°C or a site altitude >2000 m above sea level), the rated operating current I_e must be adjusted.

F KT4 Manual Motor Starters

Single, Two and Three Phase Connection Diagram

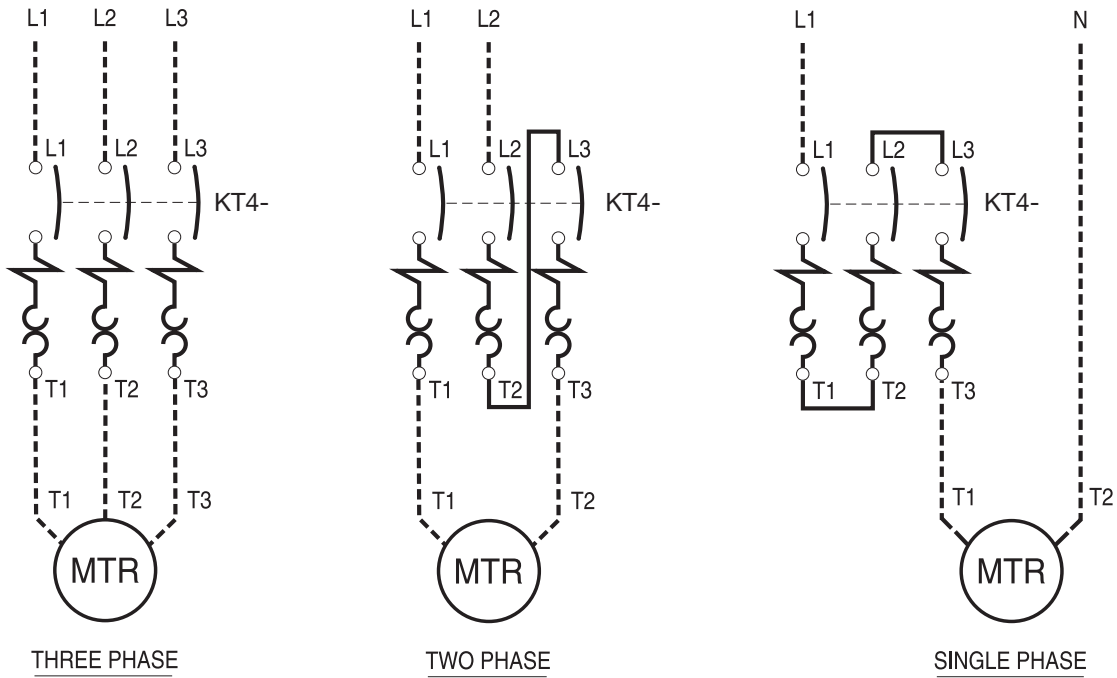

F
KT4 Manual Motor Starters

Dimensions are in millimeters (except where noted). Dimensions not intended for manufacturing purposes.

KT4 Motor Circuit Controller

KT4 with Compact Bus Bar

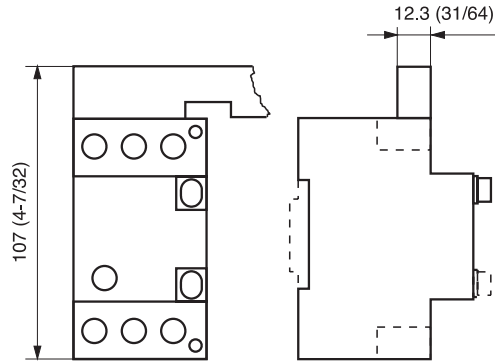
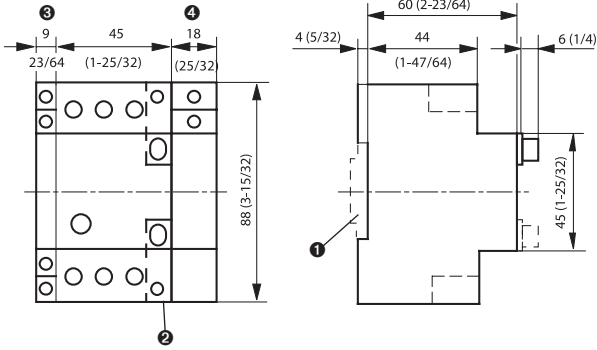

- ❶ DIN rail (EN 50022-35)
- ❷ KT4 w/KT4-C-AEA (no dimension change)
- ❸ KT4-C-ASA
- ❹ KT4-C-SXB or KT4-C-UXA

KT4-C-WT

KT4-C2A with KT4-C-WT

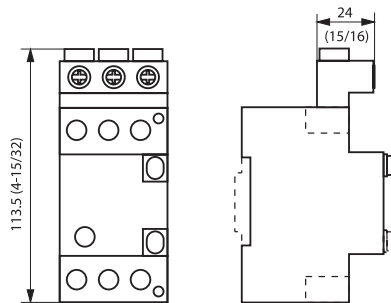
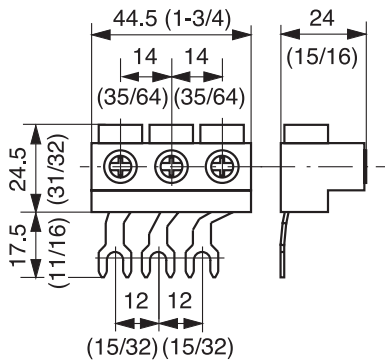

KT4-C-N12

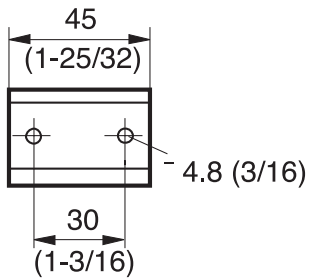

KT4-C-EA55 Enclosure

Dimensions are in millimeters (except where noted). Dimensions not intended for manufacturing purposes.

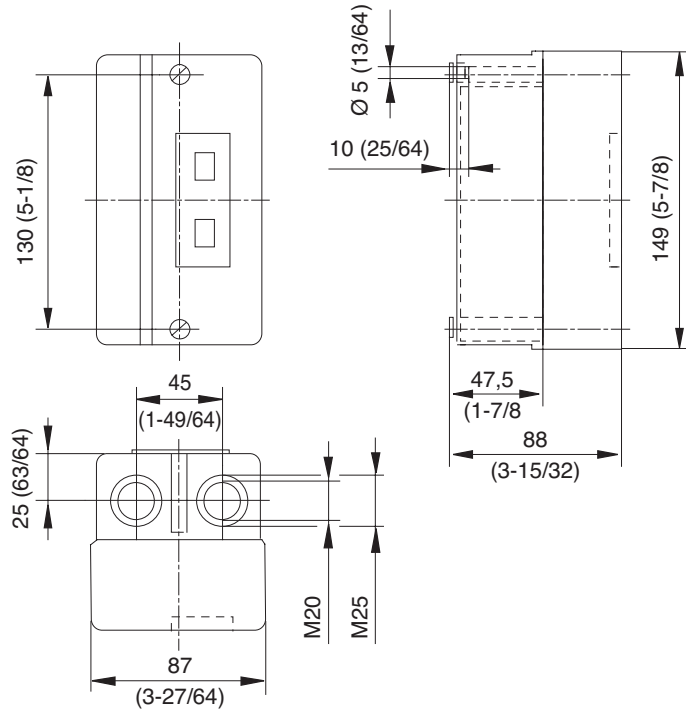

KT4-C-EE41 Enclosure

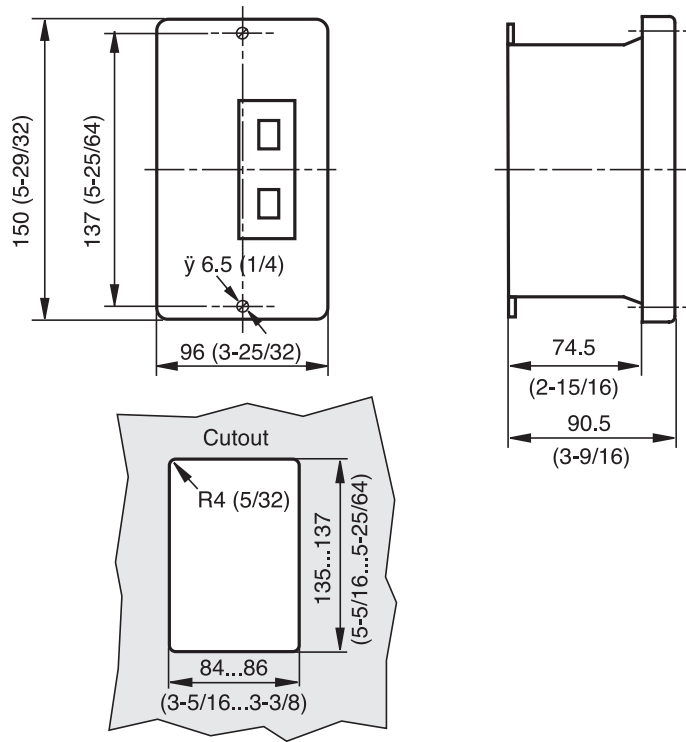

F
KT4 Manual Motor Starters

