

Electrical Data

			CA7-9	CA7-12	CA7-16	CA7-23	CA7-30	CA7-37	CA7-43	CA7-55	CA7-60	CA7-72	CA7-85	CA7-97	
Rated Insulation Voltage U_i	IEC, AS,BS,SEV, VDE 0660	[V]													
	UL; CSA	[V]							690V						
Rated Impulse Voltage U_{imp}		[kV]							600V						
Rated Voltage U_e -Main Contacts	AC 50/60Hz	[V]				115, 200, 208, 230, 240, 380, 400, 415, 460, 500, 575, 690V									
	DC	[V]				24, 48, 110, 115, 220, 230, 300, 440V									
Operating Frequency for AC Loads		[Hz]	50...60Hz												
Switching Motor Loads															
Standard IEC Ratings															
AC-2, AC-3, AC-4															
	230V	[A]	12	15	20	26.5	35	38	44	56	62	72	85	96	
	240V	[A]	12	15	20	26.5	35	38	44	56	62	72	85	95	
	400V	[A]	9	12	16	23	30	37	43	55	60	72	85	97	
	415V	[A]	9	12	16	23	30	37	43	55	60	72	85	97	
	500V	[A]	7	10	14	20	25	30	38	44	55	67	80	78	
	690V	[A]	5	7	9	12	18	21	25	25	34	42	49	57	
	230V	[kW]	3	4	5.5	7.5	10	11	13	15	18.5	22	25	30	
	240V	[kW]	3	4	5.5	7.5	10	11	13	15	18.5	22	25	30	
	400V	[kW]	4	5.5	7.5	11	15	18.5	22	30	32	40	45	55	
	415V	[kW]	4	5.5	7.5	11	15	20	22	30	32	40	45	55	
	500V	[kW]	4	5.5	7.5	13	15	20	25	30	37	45	55	55	
	690V	[kW]	4	5.5	7.5	10	15	18.5	22	22	32	40	45	55	
UL/CSA															
DOL Reversing 60Hz	10	115V	[A]	9.8	9.8	16	24	24	34	34	56	56	56	80	100
		230V	[A]	10	12	17	17	28	28	40	50	50	68	68	88
		115V	[HP]	1/2	1/2	1	2	2	3	3	5	5	5	7-1/2	10
		230V	[HP]	1 1/2	2	3	3	5	5	7-1/2	10	10	15	15	20
		200V	[A]	7.8	11	17.5	17.5	25.3	32.2	32.2	48.3	48.3	62.1	78.2	92
		230V	[A]	6.8	9.6	15.2	22	28	28	42	54	54	68	80	80
	30	460V	[A]	7.6	11	14	21	27	34	40	52	52	65	77	96
		575V	[A]	9	11	17	17	27	32	32	41	52	62	62	77
		200V	[HP]	2	3	5	5	7-1/2	10	10	15	15	20	25	30
		230V	[HP]	2	3	5	7-1/2	10	10	15	20	20	25	30	30
		460V	[HP]	5	7-1/2	10	15	20	25	30	40	40	50	60	75
		575V	[HP]	7-1/2	10	15	15	25	30	30	40	50	60	60	75
Maximum Operating Rate (at max. amps) ①	AC2	[ops/hr]	450	450	450	400	400	400	400	400	300	300	200	200	
	AC3	[ops/hr]	700	700	700	600	600	600	600	600	500	500	500	500	
	AC4	[ops/hr]	200	150	120	80	80	70	70	70	70	60	50	50	

① See page A82 for additional detail.

Electrical Data

			CA7-9	CA7-12	CA7-16	CA7-23	CA7-30	CA7-37	CA7-43	CA7-55	CA7-60	CA7-72	CA7-85	CA7-97		
Switching Motor Loads (continued)																
AC-4 200,000 Op. Cycles 50Hz	230V	[A]	4.3	6.6	9	9	12	14	16.5	22	25.5	31	38	44		
	240V	[A]	4.3	6.6	9	9	12	14	16.5	22	25.5	31	38	44		
	400V	[A]	4.3	6.6	9	9	12	14	16.5	22	25.5	31	38	44		
	415V	[A]	4.3	6.6	9	9	12	14	16.5	22	25.5	31	38	44		
	500V	[A]	4.3	6.6	9	9	12	14	16.5	22	25.5	31	38	44		
	690V	[A]	4.3	6.6	9	9	12	14	16.5	22	25.5	31	38	44		
	230V	[kW]	0.75	1.5	2.2	2.2	3	3.7	4	5.5	6.3	7.5	11	11		
	240V	[kW]	0.75	1.5	2.2	2.2	3	4	4	5.5	7.5	7.5	11	11		
	400V	[kW]	1.8	3	4	4	5.5	6.3	7.5	11	13	15	20	22		
	415V	[kW]	1.8	3	4	4	5.5	6.3	7.5	11	13	17	20	22		
	500V	[kW]	2.2	3.7	5.5	5.5	7.5	7.5	10	11	15	20	25	30		
	690V	[kW]	3	5.5	7.5	7.5	10	11	15	18.5	22	25	32	37		
	60Hz	1Ø	115V	[A]	4.3	6.6	9	10	12	14	16.5	22	25.5	31	38	44
			230V	[A]	4.3	6.6	9	10	12	14	16.5	22	25.5	31	38	44
115V			[HP]	1/8	1/4	1/3	1/2	1/2	3/4	1	1.5	2	2	3	3	
230V			[HP]	1/3	1/2	1	1-1/2	2	2	2	3	3	5	5	7-1/2	
3Ø		200V	[A]	4.3	6.6	9	10	12	14	16.5	22	25.5	31	38	44	
		230V	[A]	4.3	6.6	9	10	12	14	16.5	22	25.5	31	38	44	
		460V	[A]	4.3	6.6	9	10	12	14	16.5	22	25.5	31	38	44	
		575V	[A]	4.3	6.6	9	10	12	14	16.5	22	25.5	31	38	44	
		200V	[HP]	3/4	1	2	2	3	3	3	5	7-1/2	7-1/2	10	10	
		230V	[HP]	1	1-1/2	2	3	3	3	5	7-1/2	7-1/2	10	10	15	
		460V	[HP]	2	3	5	5	7-1/2	10	10	15	15	20	25	30	
		575V	[HP]	3	5	7-1/2	7-1/2	10	10	10	20	20	25	30	40	
		Maximum Operating Rate	[ops/hour]	250	250	220	200	200	200	200	200	200	120	120	120	120
		Wye-Delta (Star Delta) 50 Hz	230V	[kW]	5.5	7.5	10	13	17	20	22	30	32	37	45	50
240V	[kW]		5.5	7.5	10	13	18.5	20	22	30	32	40	50	50		
400V	[kW]		7.5	10	13	20	25	32	40	45	55	63	80	90		
415V	[kW]		7.5	11	15	22	25	37	40	45	55	63	80	90		
500V	[kW]		7.5	11	15	22	25	32	45	45	63	80	90	90		
690V	[kW]		7.5	10	13	18.5	25	32	40	45	55	63	80	90		
60 Hz	200V	[HP]	5	5	7-1/2	7-1/2	10	15	20	25	30	40	50	50		
	230V	[HP]	5	7-1/2	10	10	15	20	25	30	40	50	60	60		
	460V	[HP]	10	15	20	25	30	40	50	60	75	100	125	125		
	575V	[HP]	10	15	20	25	30	40	50	60	75	100	125	125		
UL/CSA Elevator Duty	200V	[A]	7.8	11.0	11.0	17.5	25.3	25.3	32.2	30.8	32.2	48.3	62.1	78.2		
	230V	[A]	6.8	9.6	15.2	15.2	22.0	28.0	28.0	42.0	42.0	54.0	68.0	80.0		
	460V	[A]	7.6	11.0	14.0	21.0	27.0	27.0	34.0	40.0	40.0	52.0	65.0	77.0		
	575V	[A]	6.1	9.0	11.0	17.0	22.0	27.0	32.0	41.0	41.0	52.0	62.0	77.0		
	200V	[HP]	2	3	3	5	7-1/2	7-1/2	10	10	10	15	20	25		
	230V	[HP]	2	3	5	5	7-1/2	10	10	15	15	20	25	30		
	460V	[HP]	5	7-1/2	10	15	20	20	25	30	30	40	50	60		
	575V	[HP]	5	7-1/2	10	15	20	25	30	40	40	50	60	75		

Electrical Data

			CA7-9	CA7-12	CA7-16	CA7-23	CA7-30	CA7-37	CA7-43	CA7-55	CA7-60	CA7-72	CA7-85	CA7-97	
AC-1 Load, 3Ø Switching Ambient Temperature 40° C	I_{th}	[A]	32	32	32	32	65	65	85	85	100	100	100	130	
	230V	[kW]	13	13	13	13	26	26	34	34	40	40	40	52	
	240V	[kW]	13	13	13	13	27	27	35	35	42	42	42	54	
	400V	[kW]	22	22	22	22	45	45	59	59	69	69	69	90	
	415V	[kW]	23	23	23	23	47	47	61	61	72	72	72	93	
	500V	[kW]	28	28	28	28	56	56	74	74	87	87	87	113	
	690V	[kW]	38	38	38	38	78	78	102	102	120	120	120	155	
Ambient Temperature 60° C	I_{th}	[A]	32	32	32	32	65	65	75	75	100	100	100	110	
	230V	[kW]	13	13	13	13	26	26	25	25	40	40	40	44	
	240V	[kW]	13	13	13	13	27	27	26	26	42	42	42	46	
	400V	[kW]	22	22	22	22	45	45	44	44	69	69	69	76	
	415V	[kW]	23	23	23	23	47	47	45	45	72	72	72	76	
	500V	[kW]	28	28	28	28	56	56	55	55	87	87	87	95	
	690V	[kW]	38	38	38	38	78	78	75	75	120	120	120	131	
Maximum Operating Rate		[ops/hour]	1,000	1,000	1,000	1,000	1,000	1,000	300	300	600	600	600	600	
Continuous Current (UL/CSA) General Purpose Rating (40°)	Open	[A]	25	25	30	30	55	60	75	75	90	90	100	120	
	Enclosed	[A]	25	25	30	30	55	60	75	75	90	90	100	120	
	Maximum Operating Rate		[ops/hour]	1,400	1,400	1,200	1,200	1,200	1,000	1000	1000	700	700	600	600
Lighting Loads ① Elec. Dischrg. Lamps-AC-5a, single compensated	Open	[A]	22.5	25	28	29	40.5	45	77	77	81	85	90	115	
	Enclosed	[A]	22.5	25	28	29	37	41	57	57	77	81	90	100	
	Max. capacitance at prospective short circuit current available at the contactor	10kA	[mf]	1,000	1,000	1,000	1,000	2,700	2,700	3,200	3,200	4,000	4,000	4,700	4,700
		20kA	[µf]	500	500	500	500	1,350	1,350	1,600	1,600	2,000	2,000	2,350	2,350
		50kA	[µf]	200	200	200	200	540	540	640	640	800	800	940	940
	Incandescent Lamps - AC -5b Electrical endurance ~ 100,000 operations		[A]	12	16	18	22	30	37	43	51	60	70	76	90
Switching power transformers AC-6a 50Hz															
Inrush	= n														
Rated transformer current		[A]	10.9	10.9	10.9	10.9	20	20	23	23	40.8	40.8	40.8	48.5	
n=30	230 VAC	[kVA]	4.3	4.3	4.3	4.3	8	8	9.2	9.2	16	16	16	19.3	
	240 VAC	[kVA]	4.5	4.5	4.5	4.5	8.3	8.3	10	10	17	17	17	20.2	
	380 VAC	[kVA]	7.2	7.2	7.2	7.2	13.2	13.2	15.4	15.4	26.9	26.9	26.9	31.9	
	400 VAC	[kVA]	7.5	7.5	7.5	7.5	14	14	16	16	28	28	28	33.6	
	415 VAC	[kVA]	7.8	7.8	7.8	7.8	14	14	17	17	29	29	29	34.9	
	500 VAC	[kVA]	9.4	9.4	9.4	9.4	17	17	20	20	35	35	35	42	
	690 VAC	[kVA]	13	13	13	13	24	24	27	27	49	49	49	58	
n=20		[A]	16.3	16.3	16.3	16.3	30	30	34.5	34.5	61.3	61.3	61.3	72.8	
	230 VAC	[kVA]	6.5	6.5	6.5	6.5	12	12	14	14	24.4	24.4	24.4	29.0	
	240 VAC	[kVA]	6.8	6.8	6.8	6.8	12.5	12.5	14.6	14.6	25.5	25.5	25.5	30.3	
	380 VAC	[kVA]	10.7	10.7	10.7	10.7	19.7	19.7	23.2	23.2	40.3	40.3	40.3	47.9	
	400 VAC	[kVA]	11.3	11.3	11.3	11.3	20.8	20.8	24.4	24.4	42.5	42.5	42.5	50.4	
	415 VAC	[kVA]	11.7	11.7	11.7	11.7	21.6	21.6	25.3	25.3	44.1	44.1	44.1	52.3	
	500 VAC	[kVA]	14.1	14.1	14.1	14.1	26	26	30.5	30.5	53.1	53.1	53.1	63.0	
690 VAC	[kVA]	19.5	19.5	19.5	19.5	35.9	35.9	42.1	42.1	73.3	73.3	73.3	86.9		
n=15		[A]	21.7	21.7	21.7	21.7	40	40	46	46	81.7	81.7	81.7	97.0	
	230 VAC	[kVA]	8.7	8.7	8.7	8.7	15.9	15.9	18.7	18.7	32.5	32.5	32.5	38.6	
	240 VAC	[kVA]	9	9	9	9	16.6	16.6	19.5	19.5	33.9	33.9	33.9	40.3	
	380 VAC	[kVA]	14.3	14.3	14.3	14.3	26.3	26.3	30.9	30.9	53.8	53.8	53.8	63.8	
	400 VAC	[kVA]	15.1	15.1	15.1	15.1	27.7	27.7	32.5	32.5	56.6	56.6	56.6	67.2	
	415 VAC	[kVA]	15.6	15.6	15.6	15.6	28.8	28.8	33.7	33.7	58.7	58.7	58.7	69.7	
	500 VAC	[kVA]	18.8	18.8	18.8	18.8	34.6	34.6	40.6	40.6	70.7	70.7	70.7	84.0	
690 VAC	[kVA]	26	26	26	26	47.8	47.8	56.1	56.1	97.6	97.6	97.6	115.9		

① CA7 ratings for lighting loads are provided for technical reference. For cUL rated and labeled devices, see CAL7 contactors listed in this section.

Electrical Data

AC-6a		CA7-9	CA7-12	CA7-16	CA7-23	CA7-30	CA7-37	CA7-43	CA7-55	CA7-60	CA7-72	CA7-85	CA7-97
Switching power transformers - 60Hz													
Inrush = n													
n=30	Rated transformer current [A]	10.9	10.9	10.9	10.9	20	20	23	23	40.8	40.8	40.8	48.5
	200 VAC [kVA]	3.8	3.8	3.8	3.8	6.9	6.9	8.0	8.0	14.1	14.1	14.1	16.8
	208 VAC [kVA]	3.9	3.9	3.9	3.9	7.2	7.2	8.3	8.3	14.7	14.7	14.7	17.5
	240 VAC [kVA]	4.5	4.5	4.5	4.5	8.3	8.3	9.6	9.6	17	17	17	20.2
	480 VAC [kVA]	9.1	9.1	9.1	9.1	16.6	16.6	19.1	19.1	33.9	33.9	33.9	40.3
	600 VAC [kVA]	11.3	11.3	11.3	11.3	20.8	20.8	23.9	23.9	42.4	42.4	42.4	50.4
	660 VAC [kVA]	12.5	12.5	12.5	12.5	22.9	22.9	26.3	26.3	46.6	46.6	46.6	55.4
n=20	[A]	16.3	16.3	16.3	16.3	30	30	34.5	34.5	61.3	61.3	61.3	72.8
	200 VAC [kVA]	5.6	5.6	5.6	5.6	10.4	10.4	12	12	21.2	21.2	21.2	25.2
	208 VAC [kVA]	5.9	5.9	5.9	5.9	10.8	10.8	12.4	12.4	22.1	22.1	22.1	26.2
	240 VAC [kVA]	6.8	6.8	6.8	6.8	12.5	12.5	14.3	14.3	25.5	25.5	25.5	30.3
	480 VAC [kVA]	13.6	13.6	13.6	13.6	24.9	24.9	28.7	28.7	51	51	51	60.5
	600 VAC [kVA]	16.9	16.9	16.9	16.9	31.2	31.2	35.9	35.9	63.7	63.7	63.7	75.7
	660 VAC [kVA]	18.6	18.6	18.6	18.6	34.3	34.3	39.4	39.4	70.1	70.1	70.1	83.2
n=15	[A]	22	22	22	22	40	40	46	46	82	82	82	97
	200 VAC [kVA]	7.5	7.5	7.5	7.5	13.9	13.9	15.9	15.9	28.4	28.4	28.4	33.6
	208 VAC [kVA]	7.8	7.8	7.8	7.8	14.4	14.4	16.6	16.6	29.5	29.5	29.5	34.9
	240 VAC [kVA]	9	9	9	9	16.6	16.6	19.1	19.1	34.1	34.1	34.1	40.3
	480 VAC [kVA]	18.1	18.1	18.1	18.1	33.3	33.3	38.2	38.2	68.2	68.2	68.2	80.6
	600 VAC [kVA]	22.6	22.6	22.6	22.6	41.6	41.6	47.8	47.8	85.2	85.2	85.2	100.8
	660 VAC [kVA]	24.9	24.9	24.9	24.9	45.7	45.7	52.6	52.6	93.7	93.7	93.7	110.9
AC-6b ①													
Capacitor Switching - 50Hz													
Single Capacitor - 40°C													
230 VAC [kVar]	8	8	8.5	9	14	14	24	24	28	28	28	28	28
240 VAC [kVar]	8	8	8.5	9	14	14	25	25	29	29	29	29	29
400 VAC [kVar]	8	8	10	12.5	20	24	35	35	48	48	48	48	48
415 VAC [kVar]	8	8	10	12.5	20	25	35	35	50	50	50	50	50
500 VAC [kVar]	8	8	10	12.5	20	25	35	35	50	55	60	60	60
690 VAC [kVar]	8	8	10	12.5	20	25	35	35	50	55	60	60	60
Single Capacitor - 60°C													
230 VAC [kVar]	8	8	8.5	9	12.5	12.5	18	18	28	28	28	28	28
240 VAC [kVar]	8	8	8.5	9	12.5	12.5	18	18	29	29	29	29	29
400 VAC [kVar]	8	8	10	12.5	20	21.5	30	30	42	48	48	48	48
415 VAC [kVar]	8	8	10	12.5	20	22	30	30	42	50	50	50	50
500 VAC [kVar]	8	8	10	12.5	20	25	30	30	42	50	55	55	55
690 VAC [kVar]	8	8	10	12.5	20	25	30	30	42	50	55	55	55
Capacitor Bank - 40°C													
230 VAC [kVar]	5	5	8	9	12.5	14	20	20	28	28	28	28	28
240 VAC [kVar]	5	5	8	9	12.5	14	20	20	29	29	29	29	29
400 VAC [kVar]	5	5	8	10	15	20	25	25	40	48	48	48	48
415 VAC [kVar]	5	5	8	10	15	20	25	25	40	50	50	50	50
500 VAC [kVar]	5	5	8	10	15	20	25	25	40	50	50	50	50
690 VAC [kVar]	5	5	8	10	15	20	25	25	40	50	50	50	50
Capacitor Bank - 60°C													
230 VAC [kVar]	5	5	8	9	12.5	12.5	18	18	28	28	28	28	28
240 VAC [kVar]	5	5	8	9	12.5	12.5	18	18	29	29	29	29	29
400 VAC [kVar]	5	5	8	10	15	20	25	25	40	48	48	48	48
415 VAC [kVar]	5	5	8	10	15	20	25	25	40	50	50	50	50
500 VAC [kVar]	5	5	8	10	15	20	25	25	40	50	50	50	50
690 VAC [kVar]	5	5	8	10	15	20	25	25	40	50	50	50	50
Capacitor Switching - 60Hz													
Single Capacitor - 40°C													
200 VAC [kVar]	5	5	8	9	12.5	14	20	20	28	28	28	28	28
230 VAC [kVar]	5	5	8	9	12.5	14	20	20	29	29	29	29	29
460 VAC [kVar]	5	5	8	10	15	20	25	25	40	50	50	50	50
600 VAC [kVar]	5	5	8	10	15	20	25	25	40	50	60	60	60
Capacitor Bank - 40°C													
200 VAC [kVar]	5	5	8	9	12.5	12.5	18	18	28	28	28	28	28
230 VAC [kVar]	5	5	8	9	12.5	12.5	18	18	29	29	29	29	29
460 VAC [kVar]	5	5	8	10	15	20	25	25	40	50	50	50	50
600 VAC [kVar]	5	5	8	10	15	20	25	25	40	50	50	50	50

① Inductance of leads between capacitors in parallel: min. 6 µH (CA7-9...CA7-30 = L min. 30 µH)

Electrical Data

		CA7-9	CA7-12	CA7-16	CA7-23	CA7-30	CA7-37	CA7-43	CA7-55	CA7-60	CA7-72	CA7-85	CA7-97	
Switching of Low Inductive Loads in Home Appliances and Similar Applications per IEC 61095 (50 Hz)														
AC-7a														
230 VAC	[A]	32	32	32	32	45	45	63	63	~	~	~	~	
400 VAC	[A]	32	32	32	32	45	45	63	63	~	~	~	~	
440 VAC	[A]	32	32	32	32	45	45	63	63	~	~	~	~	
Switching of Motor Load Home Appliances - 50 Hz														
AC-7b														
230 VAC	[A]	10.5	14	19	23	30	~	~	~	~	~	~	~	
400 VAC	[A]	9	12	16	20	30	~	~	~	~	~	~	~	
440 VAC	[A]	7.5	10	13.5	18	27	~	~	~	~	~	~	~	
Switching of Hermetically Sealed Cooling Compressor Motors - 50 Hz														
AC-8a manual reset of overload release														
400 VAC	[A]	12	16	22	32	38	45	63	63	72	85	100	115	
500 VAC	[A]	12	16	22	32	38	45	63	63	72	85	100	115	
690 VAC	[A]	8	10	14	20	28	35	42	42	56	67	80	90	
AC-8b automatic reset of overload release														
400 VAC	[A]	5.5	7	9.3	12	13	14	16	16	24	30	35	35	
500 VAC	[A]	5.5	7	9.3	12	13	14	16	16	24	30	35	35	
690 VAC	[A]	5.5	7	9.3	12	13	14	16	16	24	30	35	35	

Electrical Data

DC-1 Switching - 60°C			CA7-9	CA7-12	CA7-16	CA7-23	CA7-30	CA7-37	CA7-43	CA7-55	CA7-60	CA7-72	CA7-85	CA7-97
1 Pole	24VDC	[A]	25	25	32	32	45	45	50	50	70	80	80	80
	48VDC	[A]	20	20	20	20	25	25	30	30	40	40	40	40
	60VDC	[A]	20	20	20	20	25	25	30	30	40	40	40	40
	110VDC	[A]	6	6	6	6	8	8	9	9	11	11	11	11
	220VDC	[A]	1.5	1.5	1.5	1.5	1.5	1.5	1.5	1.5	2	2	2	2
	440VDC	[A]	0.4	0.4	0.4	0.4	0.4	0.4	0.5	0.5	0.5	0.5	0.5	0.5
2 Poles in Series	24VDC	[A]	25	25	32	32	45	45	50	50	70	80	80	80
	48VDC	[A]	25	25	32	32	45	45	50	50	70	80	80	80
	60VDC	[A]	25	25	32	32	45	45	50	50	70	80	80	80
	110VDC	[A]	25	25	32	32	45	45	50	50	70	80	80	80
	220VDC	[A]	8	8	8	8	10	10	10	10	15	15	15	15
	440VDC	[A]	1	1	1	1	1	1	1	1	1.5	1.5	1.5	1.5
3 Poles in Series	24VDC	[A]	25	25	32	32	45	45	63	63	90	90	100	100
	48VDC	[A]	25	25	32	32	45	45	63	63	90	90	100	100
	60VDC	[A]	25	25	32	32	45	45	63	63	90	90	100	100
	110VDC	[A]	25	25	32	32	45	45	63	63	90	90	100	100
	220VDC	[A]	25	25	32	32	45	45	50	50	70	80	80	80
	440VDC	[A]	3	3	3	3	3.5	3.5	4	4	5	5	5	5
DC-2, 3, 5 Switching - 60°C														
Starting, reverse current braking, reversing, DC-5, 60°C	24VDC	[A]	25	25	32	32	45	45	63	63	90	90	100	100
	48VDC	[A]	25	25	32	32	45	45	50	50	70	70	80	80
	60VDC	[A]	25	25	32	32	45	45	50	50	70	70	80	80
Shunt Wound 3 Poles in Series	110VDC	[A]	20	20	25	25	30	30	35	35	70	70	80	80
	220VDC	[A]	6	6	6	10	15	15	20	20	25	25	30	30
	440VDC	[A]	0.6	0.6	0.6	0.6	0.6	0.6	0.6	0.6	0.6	0.6	0.6	0.6
Series-wound Motors 3 Poles in Series	24VDC	[A]	25	25	32	32	45	45	63	63	90	90	100	100
	48VDC	[A]	25	25	32	32	45	45	50	50	70	70	80	80
	60VDC	[A]	25	25	32	32	45	45	50	50	70	70	80	80
	110VDC	[A]	20	20	25	25	30	30	35	35	70	70	80	80
	220VDC	[A]	6	6	6	10	15	15	20	20	25	25	30	30
440VDC	[A]	0.6	0.6	0.6	0.6	0.6	0.6	0.6	0.6	0.6	0.6	0.6	0.6	

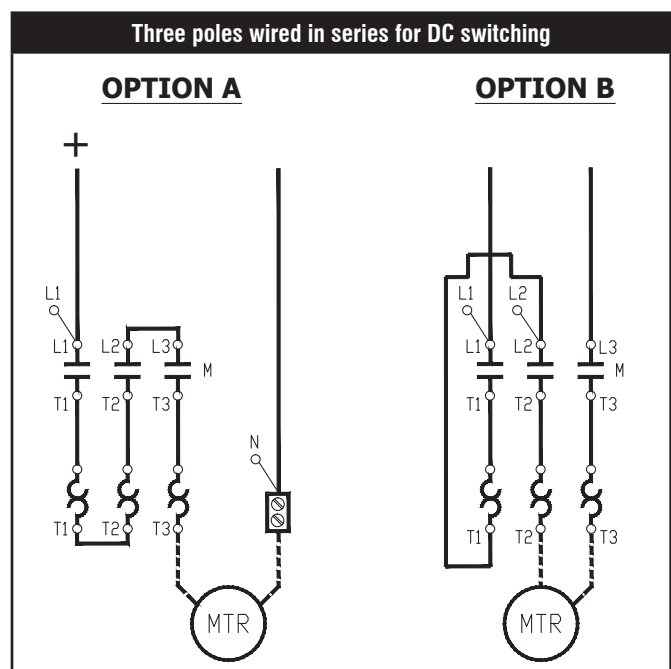

Electrical Data

	CA7-9	CA7-12	CA7-16	CA7-23	CA7-30	CA7-37	CA7-43	CA7-55	CA7-60	CA7-72	CA7-85	CA7-97
Resistance and Watt Loss I_c AC-3/ 400V												
Resistance per power pole [mΩ]	2.7	2.7	2.7	2.0	2.0	2.0	1.5	1.0	0.9	0.9	0.9	0.6
Watt Loss - 3 power poles [W]	0.66	1.2	2.1	3.2	5.4	8.2	8.3	9.1	9.7	14.0	19.5	17
Coil and 3 power poles												
AC (coil warm) [W]	3.4	3.9	4.8	6.3	8.5	11.3	11.6	12.4	16.2	18	23.5	26
DC (coil warm) [W]	2.4	2.9	3.8	4.9	7.1	9.9	10.8	11.6	13.7	18	23.5	22
Short-Circuit Coordination												
Max. Fuse or circuit breaker ratings												
DIN Fuses -gG, gL												
Available Fault Current [KA]	50	50	50	50	50	50	50	50	50	50	50	50
Type "1" (690V) Ⓢ	[A]	50	50	50	80	125	125	160	160	250	250	250
Type "2" (690V) Ⓢ	[A]	25	35	35	40	80	80	100	100	160	160	200
BS 88 Fuses												
Available Fault Current [KA]	65	65	65	65	65	65	65	Ⓢ	65	65	65	Ⓢ
Type "1" (415V) Ⓢ	[A]	25	32	40	50	63	80	Ⓢ	100	160	160	Ⓢ
Type "2" (415V) Ⓢ	[A]	20	25	32	50	63	80	Ⓢ	100	125	160	Ⓢ
cUL Short-Circuit Ratings												
Class K1, RK1, K5, and RK5 Fuses												
Available Fault Current [KA]	5	5	5	5	5	5	5	5	5	10	10	10
cUL Max. Rating (600V) Ⓢ Type 1 [A]	35	40	70	90	110	125	150	200	200	250	300	350
Class CC & CSA HRCI Fuses												
Available Fault Current [KA]	100	100	100	100	~	~	~	~	~	~	~	~
cUL Max. Rating (600V) Ⓢ Type 2 [A]	15	20	30	40	~	~	~	~	~	~	~	~
Class J CSA & HRCI-J Fuses												
Available Fault Current [KA]	100	100	100	100	100	100	100	100	100	100	100	100
cUL Max. Rating (600V) Type 2 [A]	15	20	30	40	50	50	70	70	80	100	150	175
Inverse-Time Circuit Breaker Ⓢ												
Available Fault Current [KA]	5	5	5	5	5	5	5	5	5	10	10	10
cUL Max. Rating 480V Ⓢ Type 1 [A]	30	30	50	50	125	125	125	150	250	250	250	250
cUL Max. Rating 600V Ⓢ Type 1 [A]	~	~	~	~	125	125	125	150	250	250	250	250
Short Time Current Withstand Ratings												
I _{cw} 60° C 10 s [A]	170	170	170	215	300	304	375	375	700	700	700	840
Off Time Between Operations [Min.]	20	20	20	20	20	20	20	20	20	20	20	20

Ⓢ When used as a Branch Circuit Protection device, NEC 430-152 defines the maximum rating of an Inverse-time circuit breaker to be sized at 250% of the motor nameplate FLA for most applications.

Ⓢ UL Listed Combination. (UL File E41850) Per UL508A, NEC409 abd CSA 22.2 No.14 for contactor and fuses or circuit breaker only.
 Ⓢ Per IEC 60947-1 for contactor and fuses only.
 Ⓢ To be determined - Test data not available at time of this printing.

Short Circuit Ratings

High Fault Short Circuit Ratings per UL508 and CSA 22.2 No.14

CEP7 Third Generation Cat. No.	Contactor Cat. No.	Max. starter FLC (A)	Fuse Ratings			UL Listed Circuit Breaker Ratings						
			Max. avail- able fault current (kA)	Max. voltage (V)	UL Class J/CC/ CSA HRCI-J fuse max. (A)	Short Circuit Rating (kA)	Max. voltage (V)	Max. CB Rating (A)				
CEP7	1EEAB, 1EFAB	CA7-9	100	600	3	5 ~	480 600	30 ~				
	1EEBB, 1EFBB				6							
	1EECB, 1EFCE, 1EEDB, 1EFDB, 1EEEB, 1EFEB	CA7-9			09				20			
		CA7-12 CAN7-12			12				20			
		CA7-16 CAN7-16			16				30	5 ~	480 600	50 ~
		CA7-23			23				30			
	1EEED, 1EFED, 1EEFD, 1EFFD	CA7-30	30	100	600	50	65 25	480 600	50			
		CA7-37 CAN7-37	37			50						
		CA7-43 CAN7-43	43			70			80			
		CA7-55	55			70			65 25	480 600	80	
	1EEGE, 1EFGE	CA7-60	60	100	600	80	65 25	480 600	125 125			
		CA7-72	72			100						
		CA7-85 CAN7-85	85			150						
		CA7-97	97			175			65 25	480 600	125 125	

Short Circuit Ratings

Standard Fault Short Circuit Ratings per UL508 and CSA 22.2 No.14

CEP7 Third Generation Cat. No.		Max. available fault current (kA)	Conditional S.C. current, Iq (kA)	S.C.P.D.
CEP7	1EEAB, 1EFAB, 1EEBB, 1EFBB	1	600V Max. Voltage	Suitable for use with fuses only
	1EECB, 1EFCB, 1EEDB, 1EFDB, 1EEEB, 1EFEB 1EEED, 1EFED, 1EEFD, 1EFFD	5		Not restricted to fusing only
	1EEGE, 1EFGE	10		







IEC Short Circuit Ratings per EN60947-4-1

CEP7 Third Generation Cat. No.		Prospective S.C. current, Ir (kA)	Conditional S.C. current, Iq (kA)	Max. voltage (V)	S.C.P.D.
CEP7	1EEAB, 1EFAB, 1EEBB, 1EFBB	1	100	690	Suitable for use with fuses only
	1EECB, 1EFCB, 1EEDB, 1EFDB, 1EEEB, 1EFEB	1			Not restricted to fusing only
	1EEED, 1EFED, 1EEFD, 1EFFD	3			
	1EEGE, 1EFGE	5			

IEC Type I and Type II Fuse Coordination with CA7 Series contactors per EN60947-4-1

CEP7 Third Generation Cat. No.	Contactors Cat. No.	Max. starter FLC (A)	Prospective S.C. current/ Ir (kA)	Conditional S.C. current/ Iq (kA)	Max. voltage (V)	Type I with Class J fuse max. (A)	Type II with Class J fuse max. (A)	
CEP7	1EEAB, 1EFAB 1EEBB, 1EFBB	0.5	1	100	600	3	3	
		1				6	6	
	1EECB, 1EFCB, 1EEDB, 1EFDB	CA7-9	9			1	20	15
		CA7-12	12				20	20
		CA7-16	16				30	30
		CA7-23	23				30	30
	1EEEB, 1EFEB	CA7-9	9			3	20	15
		CA7-12	12				20	20
		CA7-16	16				30	30
		CA7-23	23				30	30
	1EEED, 1EFED, 1EEFD, 1EFFD	CA7-30	30			3	50	50
		CA7-37	37				50	50
		CA7-43	43				70	70
		CA7-55	55				70	70
	1EEGE, 1EFGE	CA7-60	60			3	80	80
		CA7-72	72				100	100
		CA7-85	85				150	150
		CA7-60	60			5	80	80
		CA7-72	72				100	100
		CA7-85	85				150	150
CA7-97	97		175	175				

Electro-Mechanical Data

			CA7-9	CA7-12	CA7-16	CA7-23	CA7-30	CA7-37	CA7-43	CA7-55	CA7-60	CA7-72	CA7-85	CA7-97
Service Life														
Mechanical	AC	[Mil.]	13	13	13	13	13	13	12	12	6	6	6	6
	DC	[Mil.]	13	13	13	13	13	13	13	13	6	6	6	6
Electrical AC-3 (400V)	AC	[Mil.]	1.3	1.3	1.3	1.3	1.3	1.3	1.0	0.8	1.0	1.0	1.0	1.0
Shipping Weights														
AC - CA7		[kg]	0.39	0.39	0.39	0.39	0.48	0.49	0.51	0.51	1.45	1.45	1.45	1.45
		[Lbs.]	0.86	0.86	0.86	0.86	1.06	1.08	1.12	1.12	3.20	3.20	3.20	3.20
AC -CAU7		[kg]	0.85	0.85	0.85	0.85	1.08	1.08	1.15	1.15	3.14	3.14	3.14	3.14
		[Lbs.]	1.89	1.89	1.89	1.89	2.39	2.39	2.54	2.54	6.92	6.92	6.92	6.92
DC - CA7		[kg]	0.41	0.41	0.41	0.41	0.45	0.45	0.60	0.60	1.47	1.47	1.47	1.47
		[Lbs.]	0.90	0.90	0.90	0.91	1.00	1.00	1.32	1.32	3.24	3.24	3.24	3.24
DC - CAU7		[kg]	0.89	0.89	0.89	0.90	0.98	0.98	1.33	1.33	3.22	3.22	3.22	3.22
		[Lbs.]	1.97	1.97	1.97	1.99	2.17	2.17	3.93	2.93	7.10	7.10	7.10	7.10
Terminations - Power														
Description			 One saddleclamp per pole: cross, slotted or Pozidrive No. 2/blade No. 3 screw				 Dual connection; one saddleclamp and one box lug per pole; cross, slotted or Pozidrive No. 2/blade No. 4 screw				 Dual connection; two box lugs per pole Allen Head: 4mm, 5/32			
	1 Wire	[mm ²]	1...4				2.5...16				2.5...35			
	2 Wires	[mm ²]	1...4				2.5...10				2.5...25			
	1 Wire	[mm ²]	1.5...6				2.5...25				2.5...50			
	2 Wires	[mm ²]	1.5...6				2.5...16				2.5...35			
	1 Wire	[AWG]	16...10				14...4				14...1			
	2 Wires	[AWG]	16...10				14...4				14...1			
Torque Requirement		[Nm]	1.5...2.0				2.5...3.5				4.5...6			
		[Lb-in]	13.3...17.7				22...31				40...53			
Terminations - Control														
Description			 Combination Screw Head: Cross, Slotted, Pozidrive											
Coils	1 or 2	[mm ²]	1...2.5											
Wires		[AWG]	16...12											
Control Modules	1 or 2	[mm ²]	1...4											
Wires		[AWG]	16...12											
Torque Requirement		[Nm]	1...1.5											
		[Lb-in]	8.9...13											
Degree of Protection - contactor			CA7-9...23: IP2X from all directions CA7-30...55: IP2X from front with front (upper) terminal wired CA7-60...97: IP2X from front with front (upper) terminal wired (min. wire size 16mm ² or #6 AWG)											
Protection Against Accidental Contact			Safe from touch by fingers and back-of-hand per VDE 0106; Part 100											

Environmental and General Specifications

Ambient Temperature ①	
Storage	-55...+80° C (-67...176° F) - [CRI7E Electronic Interface -50...+80° C (-58...176° F)]
Operation	-25...+60° C (-13...140° F) (40° C per UL)
Conditioned 15% current reduction after AC-1 at >60° C	-25...+70° C (-13...158° F)
Altitude at installed site	2000 meters above sea level per IEC 60947-1
Resistance to Corrosion/Humidity	Damp-alternating climate: cyclic to IEC 68-2, 56 cycles Dry heat: IEC 68-2, +100° C (212° F), relative humidity <50%, 7 days. Damp tropical: IEC 68-2, +40° C (104° F), relative humidity <92%, 56 days.
Shock Resistance	IEC 60068-2-27: Half sinusoidal shock 11ms, 30g (in all three directions)
Vibration Resistance	IEC 60068-2-6: Static > 2g, in normal position no malfunction <5g
Pollution Degree	3
Operating Position	Refer to Dimension Pages
Standards	IEC/EN 60947-1/-4-1/-5-1; UL508; CSA 22.2 No. 14
Approvals	CE, cULus, CCC

① Ambient is the temperature outside the enclosure.

Lug Kit and Paralleling Link Specifications

			CA7-P-KN23 / KL23		CA7-P-K37	CA7-P-K43	CA7-P-K85	CA7-P-B23	CA7-P-B37
Approvals			UL Listed; CSA Certified; C						
Conformity to Standards			UL508; CSA 22.2 No. 14; IEC 60947-4						
Protection Against Accidental Contact			IP2LX Finger Protection						
Terminations									
Description			Cross, slotted or Pozidrive screw		Allen Head; 5mm, 3/16		Allen Head; 7 mm, 15/32		
Wire Size									
	1 Wire	[mm ²]	4...16	4..16	6...35	10...70	35...70	35...70	
	1 Wire	[mm ²]	4...25	4..25	6...50	10...95	35...95	35...95	
	1 Wire	[AWG]	10...4	10...4	8...2	8..2/0	0...2/0	0...2/0	
Torque Requirement			[Nm]	2...3	2...3	3..6	8...12	6...12	6...12
			[Lb-in]	18...27	18...27	27...54	72...108	54...108	54...108

Coil Data - AC / Two Winding DC

			CA7-9...12	CA7-16	CA7-23	CA7-30...37	CA7-43...55	CA7-60...85	CA7-97	
Voltage Range										
AC: 50Hz, 60Hz, 50/60 Hz	Pickup	[xU _s]							0.85...1.1	
	Dropout	[xU _s]							0.3...0.6	
DC: Two Winding (60D...97D)	Pickup	[xU _s]	0.8...1.1 (9V coils = 0.65...1.3; 24V coils = 0.7...1.25)							
	Dropout	[xU _s]	0.1...0.6							
Coil Consumption										
AC: 50Hz, 60Hz, 50/60 Hz	Pickup	[VA]	75	75	105	105	135	235	400VA/240W	
	Hold-in	[VA/W]	9.5/2.7	9.5/2.7	12.3/3.1	12.3/3.1	13.3/3.3	19/6.5	24/9	
DC: Two Winding (60D...97D)	Pickup	[W]	~						200	325
	Hold-in	[W]	~						4.5	5.5
Operating Times										
AC: 50Hz, 60Hz, 50/60 Hz	Pickup	[ms]	15...30	15...30	15...30	15...30	15...30	20...40	20...40	
	Dropout	[ms]	10...60	10...60	10...60	10...60	10...60	10...60	20...40	
with RC Suppressor	Dropout	[ms]	10...60	10...60	10...60	10...60	10...60	10...60	20...40	
DC: Two Winding (60D...97D)	Pickup	[ms]	~						20...40	15...25
	Dropout	[ms]	~						20...35 ❶	15...25 ❶

Coil Data - Electronic DC

Voltage Range			Coil Consumption & Operating Times ❷						
Voltage Code	Nominal Voltage US [VDC]	Ratings [xU _s]	Average/Peak Pickup [W]		Hold-in [W]		Dropout Voltage [xU _s]	Pickup [ms]	Dropout [ms]
			CA7-9E...37E	CA7-43E...55E	CA7-9E...37E	CA7-43E...55E			
12E	12	0.7...1.25	10/17	16/25	1.7	2.5	0.3...0.4	25...50	27...45
24E	24	0.7...1.25	10/17	16/25	1.7	2.5			
36E	36...48	0.7...1.25	10/17	16/25	1.7...1.9	2.5...2.7			
48E	48...72	0.8...1.25	10/17	16/25	1.7...1.9	2.5...2.7			
110E	110...125	0.7...1.12 ❸	12/19	16/26	2.0...2.1	2.7...2.8	0.3...0.4	25...50	23...33
220E	220...250	0.8...1.1	14/22	18/29	2.7...3.0	3.5...4.0			

❶ ≤ 220V.

❷ The hold-in demand of the CA7-9E...55E is very low but the pick-up demand is approximately 1 ampere at 24 VDC. When sizing (dimensioning) a power supply for applications involving parallel switched contactors then multiply the peak demand by the number of contactors to be simultaneously switched and add to the hold-in demand of all other control circuit burdens, including other contactors, pilot devices, solenoids, etc.

❸ At 110VDC, coil code 110E has an operating range of 0.7...1.25 xU_s.

Electrical Data

	CA7-9-M40 (31; 22)	CA7-12-M40 (31; 22)	CA7-16-M40 (31; 22)	CA7-23-M40 (31; 22)	CA7-40-M22	CA7-40-M40	CA7-90-M22	CA7-90-M40
Rated Insulation Voltage U_i								
IEC, AS, BS, SEV, VDE 0660					690V			
UL; CSA					600V			
Rated Impulse Voltage U_{imp}	8 kV							
Rated Voltage U_e - Main Contacts								
AC 50/60Hz	115, 200, 208, 230, 240, 380, 400, 415, 460, 500, 575, 690V							
DC	24, 48, 110, 115, 220, 230, 300, 440V							
Operating Frequency for AC Loads	50...60Hz							

Switching Motor Loads

Standard IEC Ratings

AC-2, AC-3, AC-4	V	[A]	12	15	20	26.5	38	38	85	85
DOL & Reversing	240v	[A]	12	15	20	26.5	38	38	85	85
50Hz/60°C	400V	[A]	9	12	16	23.	37	37	85	85
	415V	[A]	9	12	16	23	37	37	85	85
	500V	[A]	7	10	14	20	29	30	80	80
	690V	[A]	5	7	9	12	9	21	22	49
	230V	[kW]	3	4	5.5	7.5	11	11	25	25
	240V	[kW]	3	4	5.5	7.5	11	11	25	25
	400V	[kW]	4	5.5	7.5	11	18.5	18.5	45	45
	415V	[kW]	4	5.5	7.5	11	18.5	18.5	45	45
	500V	[kW]	4	5.5	7.5	13	18.5	20	55	55
	690V	[kW]	4	5.5	7.5	10	7.5	18.5	18.5	45

UL/CSA

DOL & Reversing	115V	[A]	7.2	9.8	16	24	34	34	80	80
60Hz/60°C	230V	[A]	18	12	17	17	28	28	68	68
	115V	[HP]	1/2	1/2	1	2	3	3	7-1/2	7-1/2
	230V	[HP]	1-1/2	2	3	3	5	5	15	15
	200V	[A]	7.8	11	17.5	17.5	32.2	32.2	78.2	78.2
	230V	[A]	6.8	9.6	15.2	22	28	28	80	80
	460V	[A]	7.6	11	14	21	34	34	65	77
	575V	[A]	9	11	17	17	17	32	22	52
	200V	[HP]	2	3	5	5	10	10	25	25
	230V	[HP]	2	3	5	7-1/2	10	10	30	30
	460V	[HP]	5	7-1/2	10	15	25	25	50	60
	575V	[HP]	7-1/2	10	15	15	15	30	20	50
Maximum Operating Rate	AC2	[ops/hr]	450	450	450	400	400	400	200	200
(at max. amps)	AC3	[ops/hr]	700	700	700	600	600	600	500	500
	AC4	[ops/hr]	200	150	120	80	70	70	50	50

Electrical Data

			CA7-9-M40 (31; 22)	CA7-12-M40 (31; 22)	CA7-16-M40 (31; 22)	CA7-23-M40 (31; 22)	CA7-40-M22	CA7-40-M40	CA7-90-M22	CA7-90-M40	
AC-1 Load, 3Ø Switching											
Ambient Temperature 40°C	I_{th}	[A]	32	32	32	32	75	75	130	130	
	230V	[kW]	13	13	13	13	30	30	52	52	
	240V	[kW]	13	13	13	13	31	31	54	54	
	400V	[kW]	22	22	22	22	52	52	90	90	
	415V	[kW]	23	23	23	23	54	54	93	93	
	500V	[kW]	28	28	28	28	65	65	113	113	
	690V	[kW]	38	38	38	38	90	90	155	155	
	I_{th}	[A]	32	32	32	32	60	60	110	110	
	230V	[kW]	13	13	13	13	24	24	44	44	
Ambient Temperature 60°	240V	[kW]	13	13	13	13	25	25	46	46	
	400V	[kW]	22	22	22	22	42	42	76	76	
	415V	[kW]	23	23	23	23	43	43	79	79	
	500V	[kW]	28	28	28	28	52	52	95	95	
	690V	[kW]	38	38	38	38	72	72	131	131	
Max Operating Rate	[ops/hour]		1,000	1,000	1,000	1,000	300	300	600	600	
Continuous Current (UL/CSA)											
General Purpose Rating (40°)	Open	[A]	25	25	30	30	60	60	125	130	
	Enclosed	[A]	25	25	30	30	60	60	125	130	
Max. Operating Rate	[ops/hour]		1,400	1,400	1,200	1,200	1,000	1,000	600	600	
Lighting Loads ①											
Elec. Dischrg.Lamps-AC-5a, single compensated	Open	[A]	22.5	25	28	29	65	65	115	115	
	Enclosed	[A]	22.5	25	28	29	54	54	95	95	
Incandescent Lamps AC-5b, Electrical endurance~100,000 operations			12	16	18	22	18	25	60	75	
DC-1 Switching - 60°C											
1 Pole	24VDC	[A]	25	25	32	32	45	45	80	80	
	48VDC	[A]	20	20	20	20	25	25	40	40	
	60VDC	[A]	20	20	20	20	25	30	40	40	
	110VDC	[A]	6	6	6	6	10	10	11	11	
	220VDC	[A]	1.5	1.5	1.5	1.5	1.5	1.5	1.8	1.8	
	440VDC	[A]	0.4	0.4	0.4	0.4	0.4	0.4	0.5	0.5	
2 Pole in Series	24VDC	[A]	25	25	32	32	45	45	80	80	
	48VDC	[A]	25	25	32	32	45	45	80	80	
	60VDC	[A]	25	25	32	32	45	45	80	80	
	110VDC	[A]	25	25	32	32	45	45	80	80	
	220VDC	[A]	8	8	8	8	10	10	15	15	
	440VDC	[A]	1	1	1	1	1	1	1.5	1.5	
3 Poles in Series ②	24VDC	[A]	25	25	32	32	~	48	~	100	
	48VDC	[A]	25	25	32	32	~	48	~	100	
	60VDC	[A]	25	25	32	32	~	48	~	100	
	110VDC	[A]	25	25	32	32	~	48	~	100	
	220VDC	[A]	25	25	32	32	~	48	~	80	
	440VDC	[A]	3	3	3	3	~	3.5	~	5	
4 Poles in Series	24VDC	[A]	25	25	32	32	~	60	~	110	
	48VDC	[A]	25	25	32	32	~	60	~	110	
	60VDC	[A]	25	25	32	32	~	60	~	110	
	110VDC	[A]	25	25	32	32	~	60	~	110	
	220VDC	[A]	25	25	32	32	~	60	~	100	
	440VDC	[A]	8	8	8	8	~	10	~	15	

① CA7 ratings for lighting loads are provided for technical reference. For cUL rated and labeled devices, see CAL7 contactors listed in this section.

② See page A64 for Three poles wired in series for DC switching

Electrical Data

		CA7-9-M40 (31; 22)	CA7-12-M40 (31; 22)	CA7-16-M40 (31; 22)	CA7-23-M40 (31;22)	CA7-40-M22	CA7-40-M40	CA7-90-M22	CA7-90-M40	
Resistance and Watt Loss I_e AC-3/ 400V										
Resistance per power pole	[mΩ]	2.7	2.7	2.7	2.0	2.0	1.5	0.8	0.7	
Watt Loss - 4 power poles	[W]	0.66	1.2	2.1	3.2	11.3	8.4	13.5	11.8	
Coil and 4 power poles	AC	[W]	3.4	3.9	4.8	6.3	8.8	9.5	36	56.3
	DC	[W]	2.4	2.9	3.8	4.9	8	8.7	32.5	52.8
Short Circuit Coordination										
DIN Fuses -gG, gL										
Available Fault Current	[A]	100 KA	100 KA	100 KA	100 KA	50 KA	50 KA	50 KA	50 KA	
Type "1" (690V) Ⓢ	[A]	50	50	50	80	160	160	250	250	
Type "2" (690V) Ⓢ	[A]	25	35	35	40	100	100	160	160	
BS 88 Fuses										
Available Fault Current	[A]	80 KA	80 KA	80 KA	80 KA	~	~	~	~	
Type "1" (690V) Ⓢ	[A]	25	32	35	50	~	~	~	~	
Type "2" (690V) Ⓢ	[A]	25	32	35	50	~	~	~	~	
Class K1, RK1 Fuses										
Available Fault Current	[A]	100 KA	100 KA	100 KA	100 KA	100 KA	100 KA	100 KA	100 KA	
Type "2" (600V) Ⓢ	[A]	15	20	20	30	70	70	100	100	
cUL Short-Circuit Ratings										
Class K1, RK1, K5, and RK5 Fuses										
Available Fault Current	[A]	5 KA	5 KA	5 KA	5 KA	5 KA	5 KA	10 KA	10 KA	
cUL Max. Rating (600V) Ⓢ Type 1	[A]	35	40	70	90	125	125	300	300	
Class CC & CSA HRCI Fuses										
Available Fault Current	[A]	100 KA	100 KA	100 KA	100 KA	~	~	~	~	
cUL Max. Rating (600V) Ⓢ Type 2	[A]	15	20	30	30	~	~	~	~	
Class J CSA & HRCI-J Fuses										
Available Fault Current	[A]	100 KA	100 KA	100 KA	100 KA	100 KA	100 KA	100 KA	100 KA	
cUL Max. Rating (600V) Ⓢ Type 2	[A]	15	20	30	30	70 Ⓢ	70 Ⓢ	150 Ⓢ	150 Ⓢ	
Inverse-Time Circuit Breaker Ⓢ										
Available Fault Current	[A]	5 KA	5 KA	5 KA	5 KA	5 KA	5 KA	10 KA	10 KA	
cUL Max. Rating 480V Ⓢ Type 1	[A]	30	30	50	50	125	125	250	250	
cUL Max. Rating 600V Ⓢ Type 1	[A]	~	~	~	~	125	125	250	250	
Short Time Current Withstand Ratings										
I _{cw} 60° C	[A]	170	170	170	215	304	304	700	700	
Off Time Between Operations	[Min.]	20	20	20	20	5	5	5	5	

Ⓢ When used as a Branch Circuit Protection device, NEC 430-152 defines the maximum rating of an Inverse-time circuit breaker to be sized at 250% of the motor nameplate FLA for most applications.

Ⓢ UL Listed Combination. (UL File E41850) Per UL508A, NEC409 abd CSA 22.2 No.14 for contactor and fuses or circuit breaker only.

Ⓢ Per IEC 60947-1 for contactor and fuses only.

Ⓢ UL Testing not complete a the time of printing this catalog.

Mechanical Data

			CA7-9-M40 (31; 22)	CA7-12-M40 (31; 22)	CA7-16-M40 (31; 22)	CA7-23-M40 (31; 22) CAL7-20	CA7-40-M22	CA7-40-M40 CAL7-30	CA7-90-M22	CA7-90-M40 CAL7-60	
Service Life											
Mechanical	AC	[Mil.]	13	13	13	13	10	10	10	10	
	DC	[Mil.]	13	13	13	13	10	10	10	10	
Shipping Weights											
AC - CA7		[kg]	0.39	0.39	0.39	0.39	0.51	0.51	1.45	1.45	
		[Lbs.]	0.86	0.86	0.86	0.86	1.12	1.12	3.20	3.20	
DC - CA7		[kg]	0.41	0.41	0.41	0.41	0.59	0.59	1.47	1.47	
		[Lbs.]	0.90	0.90	0.90	0.91	1.30	1.30	3.24	3.24	
Terminations - Power											
Description											
			One saddleclamp per pole: cross, slotted or Pozidrive No. 2/blade No. 3 screw				Dual connection; one saddleclamp and one box lug per pole; cross, slotted or Pozidrive No. 2/ blade No. 4 screw		Dual connection; two box lugs per pole Allen Head: 4mm, 5/32		
	1 Wire	[mm ²]	1...4	1...4	1...4	1...4	2.5...10	2.5...10	2.5...16	2.5...35	
	2 Wires	[mm ²]	1...4	1...4	1...4	1...4	2.5...10	2.5...10	2.5...10	2.5...25	
	1 Wire	[mm ²]	1.5...6	1.5...6	1.5...6	1.5...6	2.5...16	2.5...16	2.5...25	2.5...50	
	2 Wires	[mm ²]	1.5...6	1.5...6	1.5...6	1.5...6	2.5...16	2.5...16	2.5...16	2.5...35	
	1 Wire	[AWG]	16...10	16...10	16...10	16...10	14...6	14...6	14...4	14...1	
	2 Wires	[AWG]	16...10	16...10	16...10	16...10	14...6	14...6	14...4	14...1	
Torque Requirement		[Nm]	1.5...2.0	1.5...2.0	1.5...2.0	1.5...2.0	2.5...3.5	2.5...3.5	3.5...6	3.5...6	
		[Lb-in]	13.3...17.7	13.3...17.7	13.3...17.7	13.3...17.7	22...31	22...31	31...52	31...52	
Terminations - Control											
Description											
			Combination Screw Head: Cross, Slotted, Pozidrive								
Coils	1 or 2	[mm ²]	1...2.5								
Wires		[AWG]	16...12								
Control Modules	1 or 2	[mm ²]	1...4								
Wires		[AWG]	16...12								
Torque Requirement		[Nm]	1...1.5								
		[Lb-in]	8.9...13								
Degree of Protection - contactor			CA7-9...23: IP2X from all directions CA7-30...55: IP2X from front with front (upper) terminal wired CA7-60...97: IP2X from front with front (upper) terminal wired (min. wire size 16mm ² or #6 AWG)								
Protection Against Accidental Contact			Safe from touch by fingers and back-of-hand per VDE 0106; Part 100								

Environmental and General Specifications

Ambient Temperature ①		-55...+80° C (-67...176° F) - [CRI7E Electronic Interface -50...+80° C (-58...176° F)]
Storage		
Operation		-25...+60° C (-13...140° F) (40° C per UL)
Conditioned 15% current reduction after AC-1 at >60° C		-25...+70° C (-13...158° F)
Altitude at installed site		2000 meters above sea level per IEC 60947-1
Resistance to Corrosion/Humidity		Damp-alternating climate: cyclic to IEC 68-2, 56 cycles Dry heat: IEC 68-2, +100° C (212° F), relative humidity <50%, 7 days. Damp tropical: IEC 68-2, +40° C (104° F), relative humidity <92%, 56 days. IEC 60068-2-27: Half sinusoidal shock 11ms, 30g (in all three directions) IEC 60068-2-6: Static > 2g, in normal position no malfunction <5g
Shock Resistance		
Vibration Resistance		
Pollution Degree		3
Operating Position		Refer to Dimension Pages
Standards		IEC/EN 60947-1/-4-1/-5-1; UL508; CSA 22.2 No. 14
Approvals		CE, cULus, CCC

① Ambient is the temperature outside the enclosure.

Coil Data - AC / Two Winding DC

			CA7-9-M40 (31; 22)	CA7-12-M40 (31; 22)	CA7-16-M40 (31; 22)	CA7-23-M40 (31; 22)	CA7-40-M22 CAL7-20	CA7-40-M40 CAL7-30	CA7-90-M22	CA7-90-M40 CAL7-60
Voltage Range										
AC: 50Hz, 60Hz, 50/60 Hz	Pickup	[xU _s]							0.85...1.1	
	Dropout	[xU _s]							0.3...0.6	
DC, Two Winding (90D)	Pickup	[xU _s]	0.8...1.1 (9V coils = 0.65...1.3; 24V coils = 0.7...1.25)							
	Dropout	[xU _s]	0.1...0.6							
Coil Consumption										
AC: 50Hz, 60Hz, 50/60 Hz	Pickup	[VA]	75	75	75	105	135	135	400VA/240W	400VA/240W
	Hold-in	[VA/W]	9.5/2.7	9.5/2.7	9.5/2.7	12.3/3.1	13.3/3.3	13.3/3.3	24/9	24/9
DC: Two Winding (90D)	Pickup	[W]	~	~	~	~	~	~	325	325
	Hold-in	[W]	~	~	~	~	~	~	5.5	5.5
Operating Times										
AC: 50Hz, 60Hz, 50/60 Hz	Pickup	[ms]	15...30	15...30	15...30	15...30	15...30	15...30	20...30	20...40
	Dropout	[ms]	10...60	10...60	10...60	10...60	10...60	10...60	20...40	20...40
with RC Suppressor	Dropout	[ms]	10...60	10...60	10...60	10...60	10...60	10...60	20...40	20...40
DC: Two Winding (90D)	Pickup	[ms]	~	~	~	~	~	~	15...20	15...25
	Dropout	[ms]	~	~	~	~	~	~	20...25	15...25

Coil Data - Electronic DC

Voltage Range			Coil Consumption & Operating Times ①						
Voltage Code	Nominal Voltage US [VDC]	Ratings [xU _s]	Average/Peak Pickup [W]		Hold-in [W]		Dropout Voltage [xU _s]	Pickup [ms]	Dropout [ms]
			CA7-9E...37E	CA7-40E	CA7-9E...37E	CA7-40E			
12E	12	0.7...1.25	10/17	16/25	1.7	2.5	0.3...0.4	25...50	27...45
24E	24	0.7...1.25	10/17	16/25	1.7	2.5			
36E	36...48	0.7...1.25	10/17	16/25	1.7...1.9	2.5...2.7			
48E	48...72	0.8...1.25	10/17	16/25	1.7...1.9	2.5...2.7			
110E	110...125	0.7...1.25	12/19	16/26	2.0...2.1	2.7...2.8	0.3...0.4	25...50	23...33
220E	220...250	0.7...1.1	14/22	18/29	2.7...3.0	3.5...4.0			

① The hold-in demand of the CA7-9E...55E is very low but the pick-up demand is approximately 1 ampere at 24 VDC. When sizing (dimensioning) a power supply for applications involving parallel switched contactors then multiply the peak demand by the number of contactors to be simultaneously switched and add to the hold-in demand of all other control circuit burdens, including other contactors, pilot devices, solenoids, etc.

Technical Information – Auxiliary Contact Data

			Built-in Auxiliary Contacts in Contactor CA7-9...CA7-23	Front Mounted Auxiliary Contacts CA7-PV, CS7-PV, CZE/A7, CV7	Front Mounted Bifurcated Auxiliary Contacts	Side Mounted Auxiliary Contacts CA-PA, CM7
Electrical Contact Ratings - NEMA			A600, P600	A600, Q600		A600, Q600
Min. Contact Rating			17V, 10 mA	17V, 5 mA	5V, 3 mA	17V, 10 mA
Contact Ratings - IEC AC-15 (solenoids, contactors) rated voltage IEC 60947-5-1		24V	10 A	6 A	3 A	6 A
		48V	10 A	6 A	3 A	6 A
		120V	10 A	6 A	3 A	6 A
		240V	10 A	5 A	3 A	5 A
		400V	6 A	3 A	2 A	3 A
		480V/500V	2.5 A	1.6 A	1.2 A	1.6 A
		600V	1 A	1 A	0.7 A	1 A
AC-12 (Control of resistive loads) IEC 60947-5-1	40 °C	I_{th}	20 A	10 A	10 A	10 A
		230V	8 kW			
		400V	14 kW			
		690V	24 kW			
	60 °C	I_{th}	20 A	6 A	6 A	6 A
		230V	8 kW			
400V		14 kW				
690V		24 kW				
DC-12 Switching DC Loads $t_{\text{off}} < 1 \text{ ms}$, Resistive Loads IEC 60947-5-1		24V	12 A	12 A	6 A	6 A
		48V	9 A	9 A	3.2 A	3.2 A
		110V	3.5 A	3.5 A	0.45 A	0.45 A
		220V	0.55 A	0.55 A	0.18 A	0.18 A
		440V	0.2 A	0.2 A	0.1 A	0.1 A
DC-13 IEC 60947-5-1, Solenoids and contactors		24V	5 A	5 A	2.5 A	5 A
		48V	3 A	3 A	1.5 A	3 A
		110V	1.2 A	1.2 A	0.6 A	1.2 A
		220V	0.6 A	0.6 A	0.3 A	0.6 A
		440V	0.3 A	0.15 A	0.15 A	0.15 A

Terminal Marking Information for Built In Auxiliary Contacts

CA7-9...23-10 Typical

CA7-9...23-01 Typical



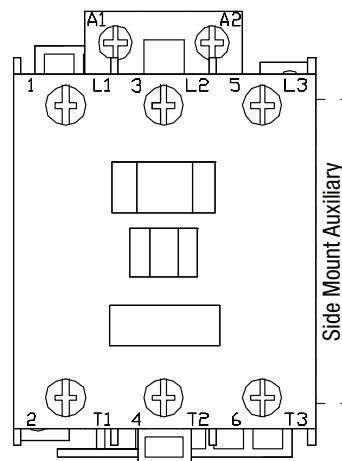
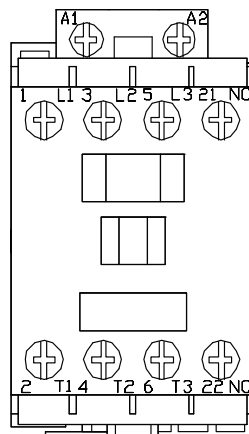
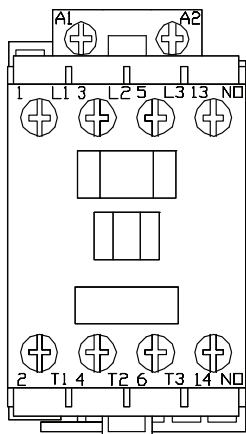



CA7-30...97 Typical



Auxiliary Contacts

			Built-in Auxiliary Contacts in Contactor CA7-9...CA7-23	Front Mounted Auxiliary Contacts CA7-PV, CS7-PV, CZE/A7, CV7	Side Mounted Auxiliary Contacts CA-PA, CM7
Continuous Current Rating per UL/CSA					
Rated Voltage	AC	[V]	600 max.	600 max.	600 max.
Continuous Rating	40°C	[A]	10 A general purpose Heavy pilot duty (A600)	10 A general purpose Heavy pilot duty (A600)	10 A general purpose Heavy pilot duty (A600)
Continuous Rating	DC	[A]	5A, 600 max. Standard pilot duty (P600)	2.5A, 600 max. Standard pilot duty (Q600)	2.5A, 600 max. Standard pilot duty (Q600)
Short-Circuit Protection -gGFuse					
Type 2 Coordination		[A]	20	10	10
Rated Impulse Voltage U_{imp}					
		[kV]	8	8	6
Insulation Voltage (between control and load circuit) per DIN < VDE 0103, Part 101 (NAMUR recommendation)					
		[V]	380	440	440
Mechanically Linked Contacts (per IEC60947-5-1 ● Annex L (SUVA Third-party certified))					
			Mutually unrestricted between all NO and NC contacts	Mutually unrestricted between all NO & NC contacts. CZE & CV7 not mechanically linked with contactor main contacts	Mutually unrestricted between all NO and NC contacts

Terminals

Terminal Type				
Maximum Wire Size per IEC 947-1		2xA4	2xA4	2xA4
 Flexible with Wire-End	1 conductor [mm ²]	1...4	0.5...2.5	0.5...2.5
 Fernule	2 conductor [mm ²]	1...4	0.75...2.6	0.75...2.6
 Solid/Stranded-Conductor	1 conductor [mm ²]	1.5...6	0.5...2.5	0.5...2.5
	2 conductor [mm ²]	1.5...6	0.75...2.6	0.75...2.6
Recommended Tightening Torque	[Nm]	1.5...2.5	1...1.5	1...1.5
Max. Wire Size per UL/CSA	[AWG]	16...10	16...12	16...12
Recommended Tightening Torque	[lb-in]	13...22	8.9...13	8.9...13

Accessories

Latch Attachment Release, CV7-11		
Coil Consumption	[VA/W]	AC 45/40
	[W]	DC 25W
Contact Signal Duration	[min/max]	0.03...15s
Time Attachment, CRZE7, CRZA7		
Reset Time		
at min. time setting	[ms]	10
at max. time setting	[ms]	70
Repeat Accuracy		±10%

Contact Ratings (Per NEMA/UL A600 & Q600)

Standard	Circuit Voltage	Make (Amps/VA)	Break (Amps/VA)	Continuous Amps
A600	120AC	60A/7200VA	6A/720VA	10
	240AC	30A/7200VA	3A/720VA	
	480AC	15A/7200VA	1.5A/720VA	
	600AC	12A/7200VA	1.2A/720VA	
Q600	125DC	0.55A/69VA	0.55A/69VA	25
	250DC	0.27A/69VA	0.27A/69VA	
	301-600DC	0.1A/69VA	0.1A/69VA	

Positively-Guided Contacts (Mechanically-linked)

SUVA Certified

- Restricted guidance guarantees without restrictions from contactor to auxiliary contact and auxiliary contact to contactor.●

● See Section G for additional details.

Life-Load Curves

- Locate the Rated Operational Current (I_g) along the bottom of the chart and follow the graph lines up to the intersection of the appropriate contactor's life-load curve.
- Read the estimated contact life along the vertical axis.

Instructions on *How to* read Life Curves can be found on page A8

AC-1
(to 690V)

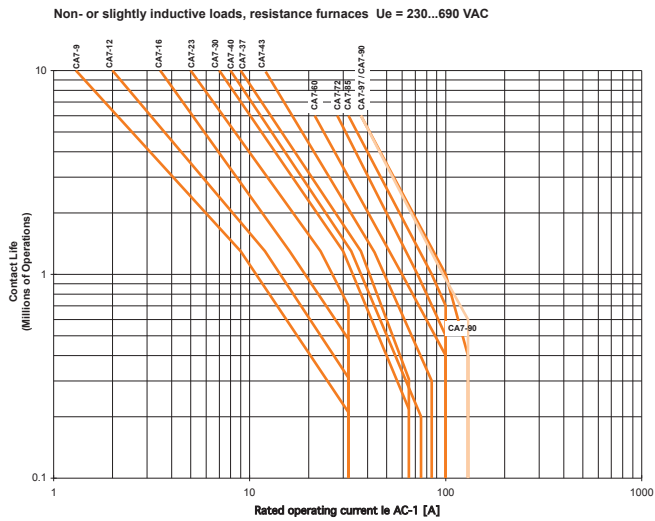

AC-2
(to 460V)

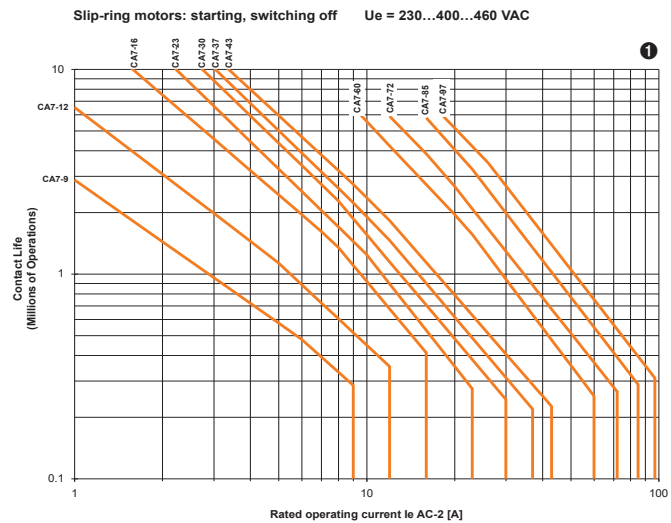

AC-3
(to 460V)

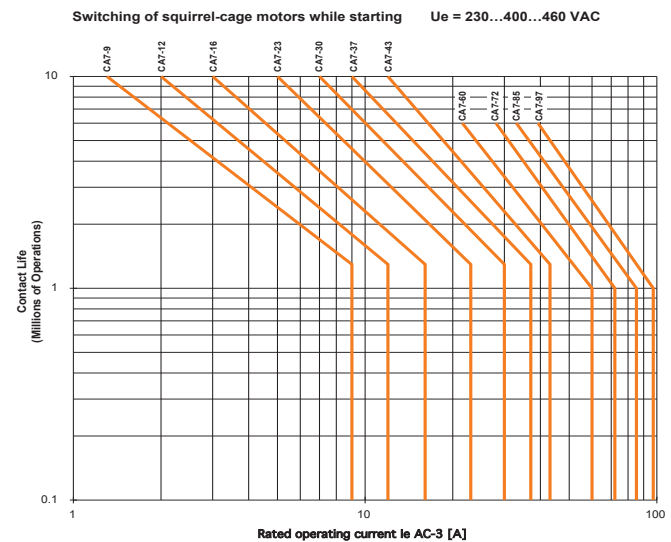

NOTE: The life-load curves shown here are based on Sprecher+Schuh tests according to the requirements defined in IEC 60947-4-1. Since contact life in any given application is dependent on environmental conditions and duty cycle, actual application contact life may vary from that indicated by the curves shown here.

① 575V applications use 90% of curve value.

Life-Load Curves

- Locate the Rated Operational Current (I_B) along the bottom of the chart and follow the graph lines up to the intersection of the appropriate contactor's life-load curve.
- Read the estimated contact life along the vertical axis.

AC-3
(to 575V)

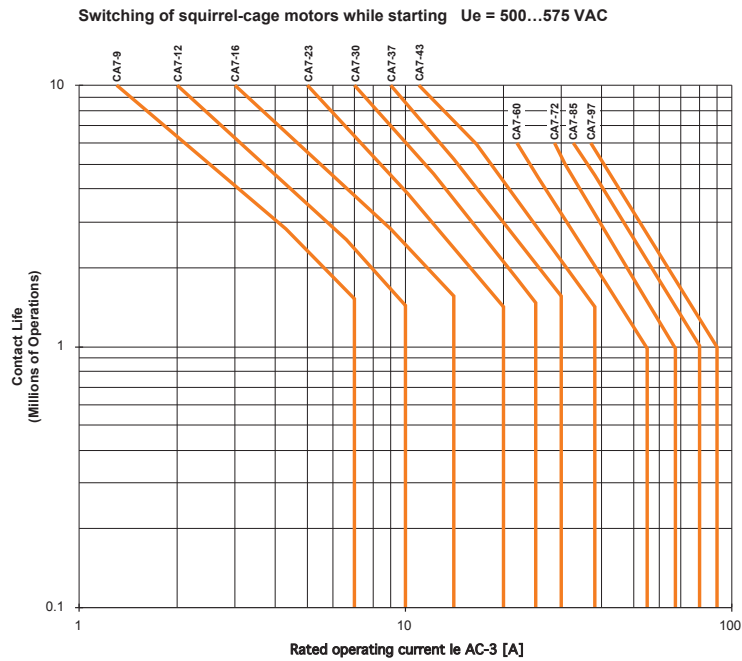

AC-3
(to 690V)

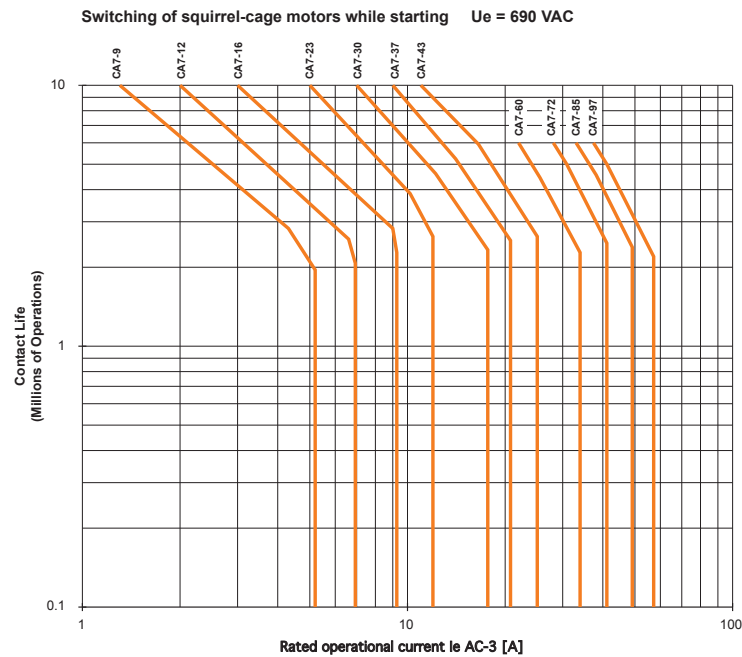

NOTE: The life-load curves shown here are based on Sprecher+Schuh tests according to the requirements defined in IEC 60947-4-1. Since contact life in any given application is dependent on environmental conditions and duty cycle, actual application contact life may vary from that indicated by the curves shown here.

Life-Load Curves

- Locate the Rated Operational Current (I_g) along the bottom of the chart and follow the graph lines up to the intersection of the appropriate contactor's life-load curve.
- Read the estimated contact life along the vertical axis.

AC-4
(to 460V)

Squirrel-cage motors: starting, plugging, inching $U_e = 230...460$ VAC

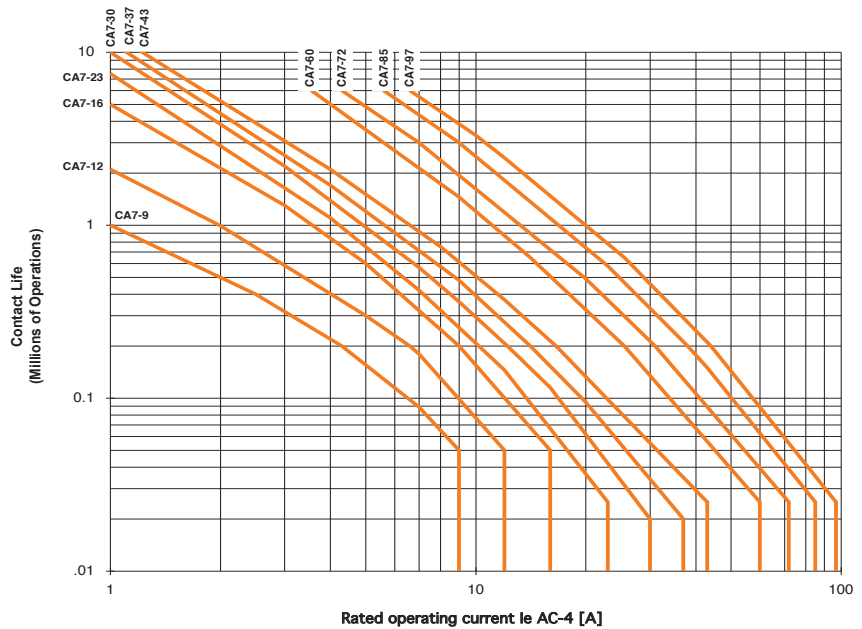

AC-4
(to 690V)

Squirrel-cage motors: starting, plugging, inching $U_e = 230...690$ VAC

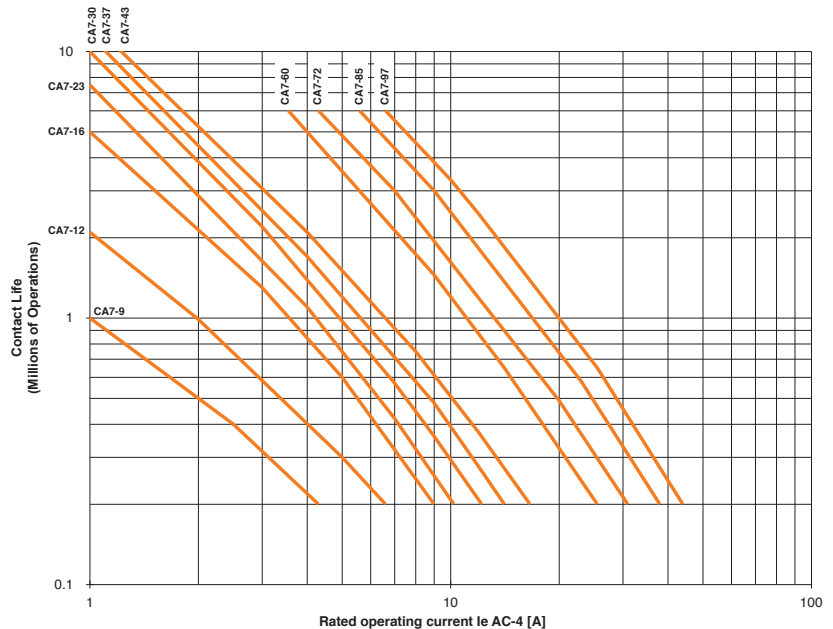

NOTE: The life-load curves shown here are based on Sprecher+Schuh tests according to the requirements defined in IEC 60947-4-1. Since contact life in any given application is dependent on environmental conditions and duty cycle, actual application contact life may vary from that indicated by the curves shown here.

Contact Life for Mixed Utilization Categories AC-3 and AC-4

In many applications, the utilization category cannot be defined as either purely AC-3 or AC-4. In those applications, the electrical life of the contactor can be estimated with the following equation:

$$L_{mixed} = L_{ac3} / [1 + P_{ac4} \times (L_{ac3} / L_{ac4} - 1)], \text{ where:}$$

L_{mixed} Approximate contact life in operations for a mixed AC-3/AC-4 utilization category application.

L_{ac3} Approximate contact life in operations for a pure AC-3 utilization category (from the AC-3 life-load curve).

L_{ac4} Approximate contact life in operations for a pure AC-4 utilization category (from the AC-4 life-load curve).

P_{ac4} Percentage of AC-4 operations

**AC-3 (90%),
AC-4 (10%)**

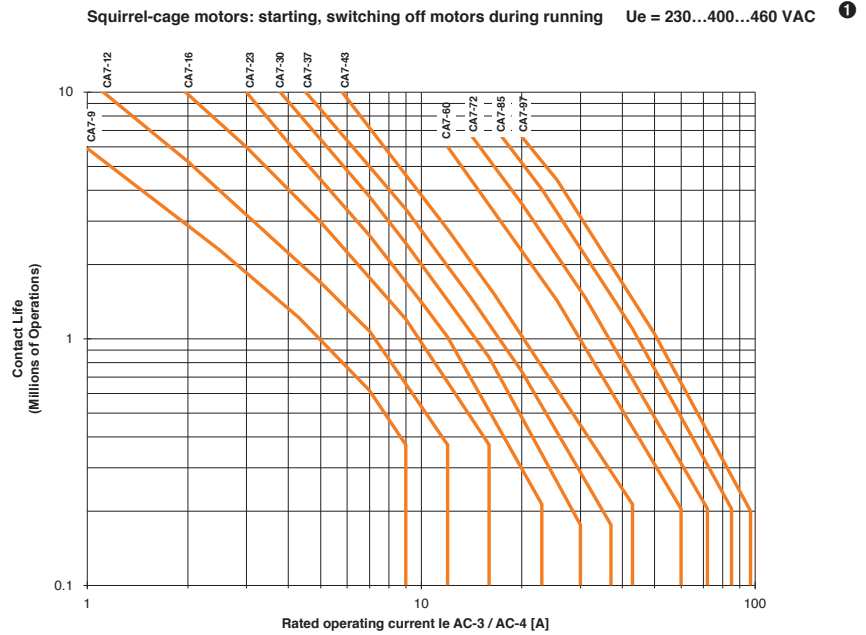

**AC-3 (75%),
AC-4 (25%)**

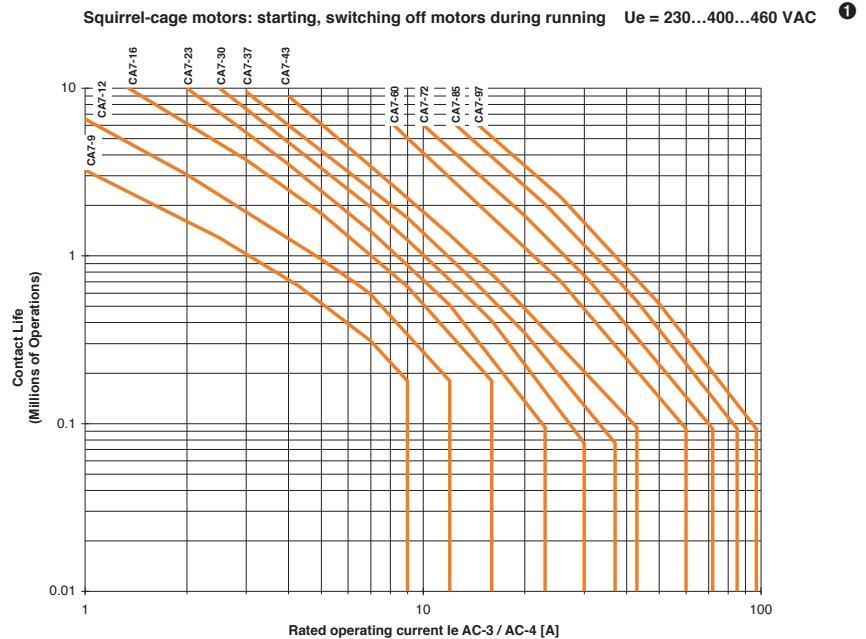

① 575V applications use 85% of curve value.

Contact Life for Special Applications

Heavy duty Starting and Regular Short-time Operation

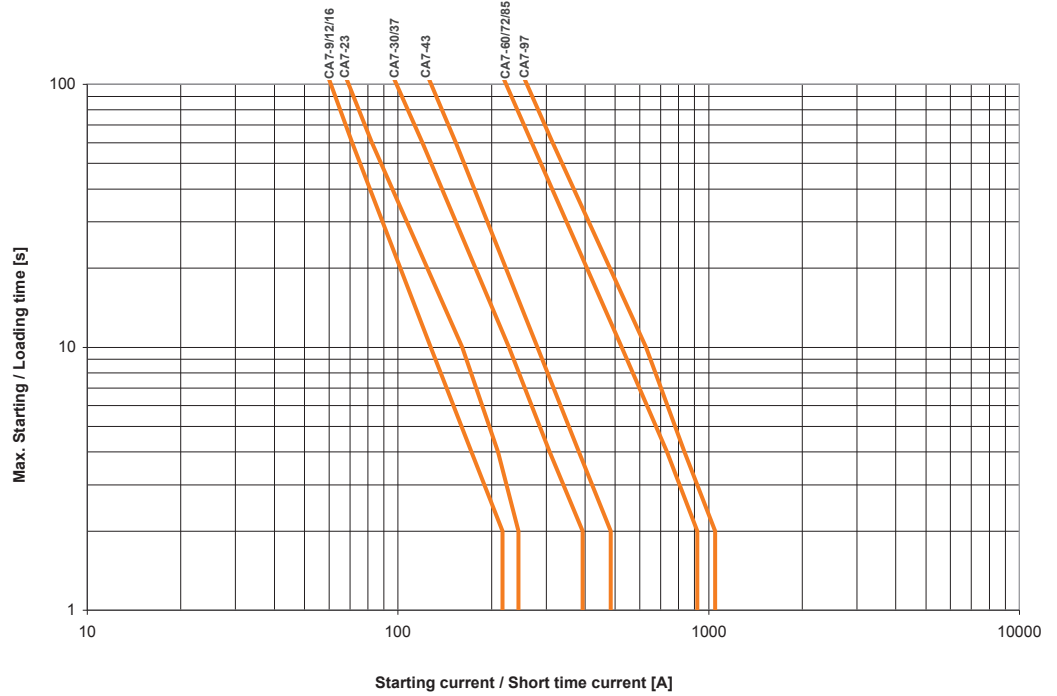

Short-time withstand current I_{cw} at 60°

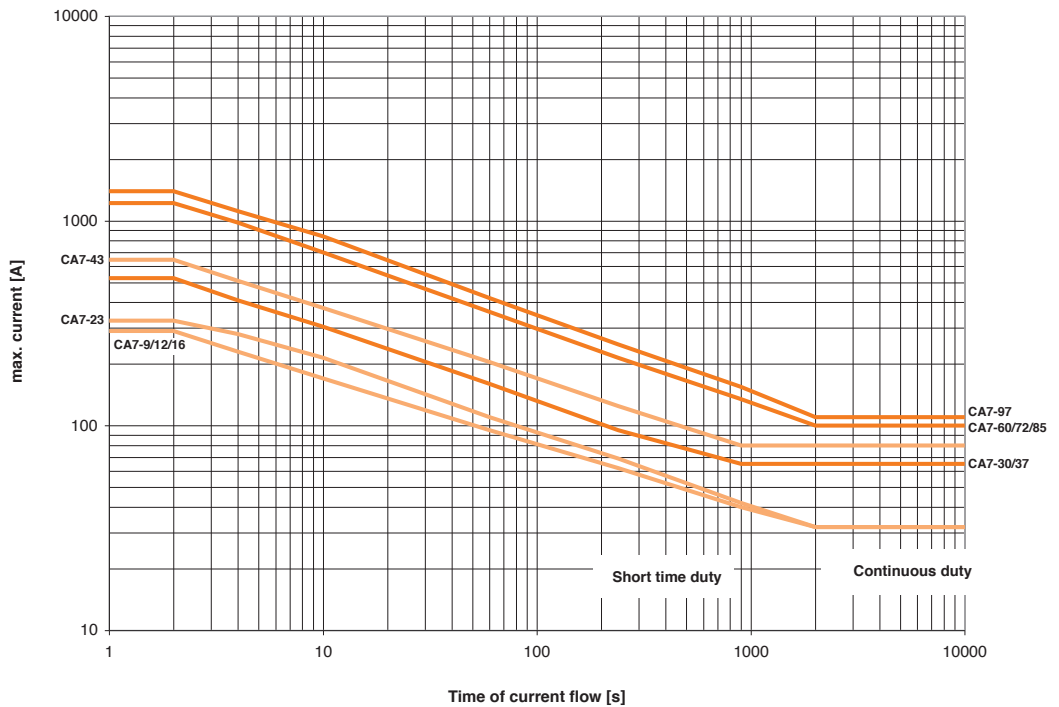

Operating Rates

The estimated contact life shown in the life-load curves is based on the standard operating rates shown in Table B below. For applications requiring a higher operating frequency, the maximum operating power (Pn in kW or HP) for a given contactor must be reduced to maintain the same contact life.

To find a contactor’s maximum operating power, for an operating rate greater than shown in Table B, follow these guidelines:

1. Identify the appropriate curve for the contactor and utilization category from Table B.
2. Locate the appropriate Maximum Operating Rate curve on the following pages.
3. Locate the intersection of the curve with the application’s operating rate (ops/hr.) found on the vertical axis.

4. Read the percent of maximum operating power (Pn) of the contactor from the horizontal axis.
 5. Multiply the % maximum power by the standard power rating.
- Example: The contactor selected for an AC-4 utilization category application is a CA7-16 (10HP at 460V), however, the application requires an operating rate of 200 ops/hr., compared to the standard operating rate of 120 ops/hr. as shown in Table B.
1. Locate the AC-4 Maximum Operating Rate curve on the following pages.
 2. Locate the intersection of 200 ops/hr on the CA7-16 curve. The data shows that the maximum operating power of the CA7-16 contactor in this application is 60%.
 3. Therefore, the maximum horsepower that can be switched by the CA7-16 contactor in this application is 6 HP (0.60 x 10HP).

Table B – Standard Operating Rates by Contactor and Utilization Category

Contactor	AC-1	AC-2	AC-3	AC-4	AC-4 @ I _e for
	Max. ops/hr.	Max. ops/hr.	Max. ops/hr.	Max. ops/hr.	200K ops.
	Max. ops/hr.				
Operating Parameters and Start Time					
			40% Duty Cycle 250ms ❶	250ms	250ms
CA7-9	1000	500	700	200	400
CA7-12	1000	500	700	150	300
CA7-16	1000	500	700	120	240
CA7-23	1000	400	600	80	160
CA7-30	400	400	600	80	160
CA7-37	400	400	600	70	140
CA7-43	300	400	600	70	140
CA7-55	300	400	600	70	140
CA7-60	600	300	500	70	140
CA7-72	600	300	500	60	120
CA7-85	600	200	500	50	140
CA7-97	250	200	500	50	140

❶ Duty Cycle or Load Factor – Defined as the “on” time for a given operating cycle per hour including the “start time.” A 40% Duty Cycle is calculated in the following manner:

Contactor switches six (6) times per minute (tpm), 250ms start time; 40% duty cycle.

To determine the “on” time and “off” time:

- Operations per hour = 360; [60 min x 6 tpm = 360]
- One operating cycle = 10 sec; [60 min ÷ 6 tpm = 10 sec]
- “On” time at 40% duty cycle = 4 sec; [10 sec x 0.4 (40%) = 4 sec]
- 4 sec “on” time includes the start time of 250ms
- “Off” time at 40% duty cycle = 6 sec; [10 sec – 4 sec = 6 sec]

Operating Rate Curves

AC-1

Non- or slightly inductive loads, resistance furnaces Ue = 230...690 VAC

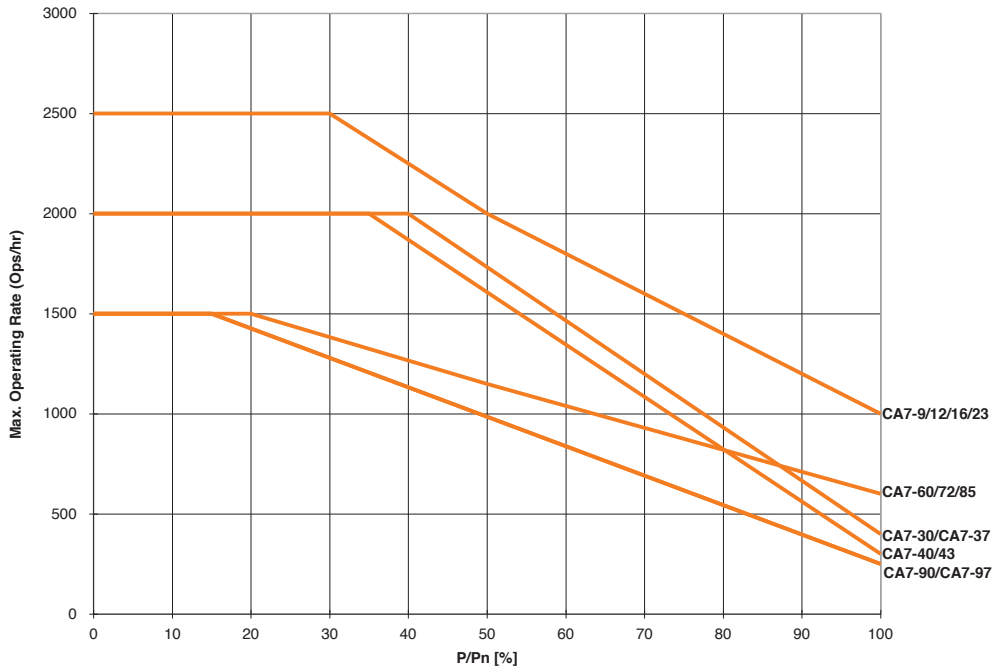

AC-2

Slip-ring motors: starting, switching off Ue = 230...460 VAC

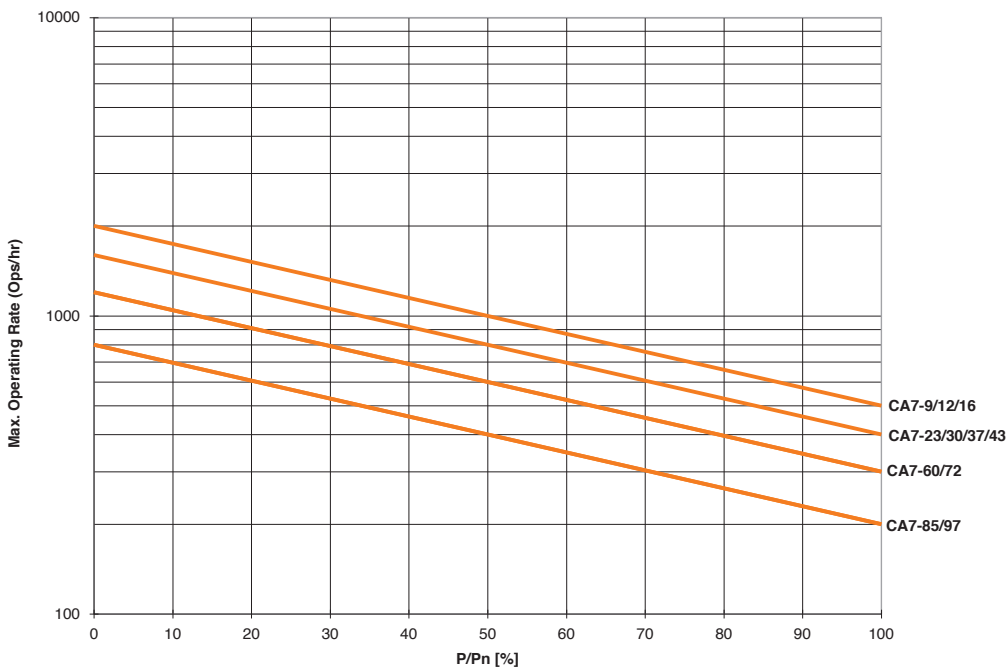

A

Operating Rate Curves

CA7 Contactors

AC-3

Squirrel-cage motors: starting, switching off motors during running
250ms Start-up, 40% Duty Cycle
Ue = 230...460VAC

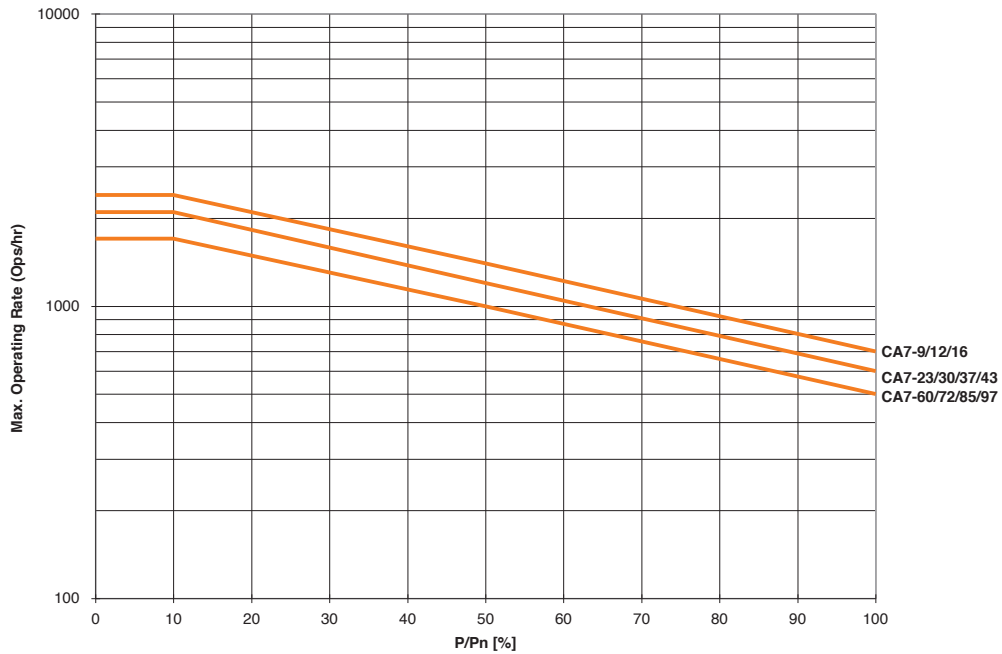

AC-4

Squirrel-cage motors: starting, plugging, inching
250ms Start-up
Ue=230...460VAC

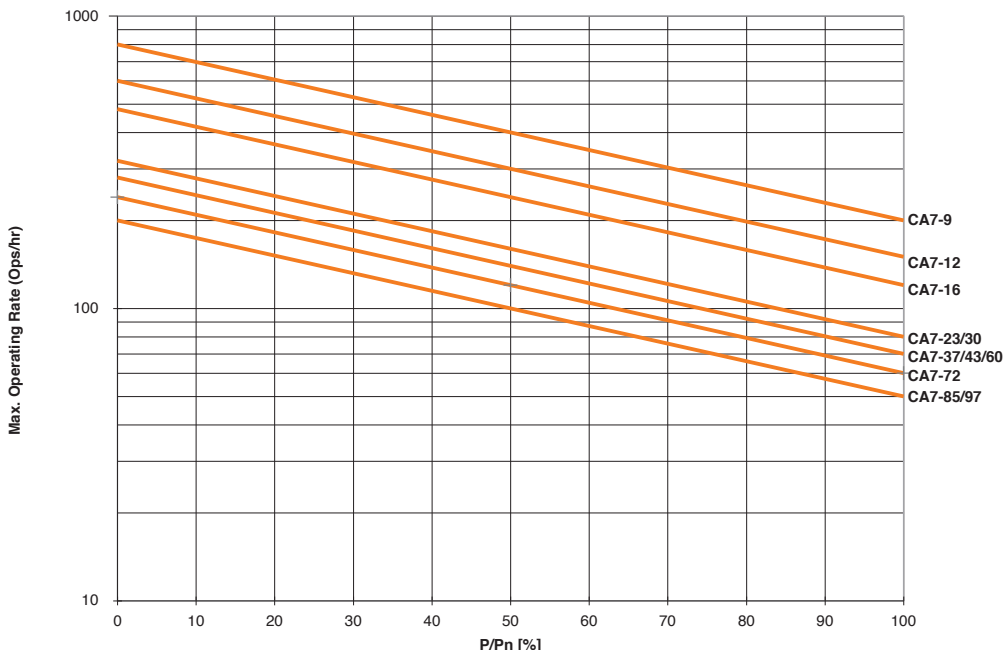

Series CA7, CAU7, CNX, CAN7 and CAL7 (Contactors, Reversing Contactors & Special Use Contactors)

Dimensions are in millimeters (inches). Dimensions not intended for manufacturing purposes.

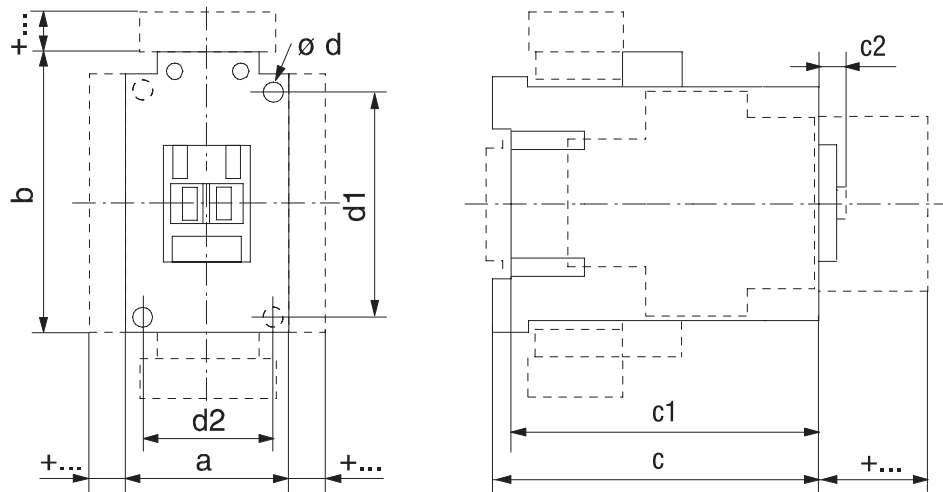

	Catalog Number	a	b	c	c1	c2	ød	d1	d2
AC Contactors	CA7-9...CA7-23; CAN7-12, CAN7-16, CNX-205...208; CA(V)L7-20	45 (1-25/32)	81 (3-3/16)	80.5 (3-11/64)	75.5 (3-3/32)	6 (1/4)	① 4.5 (3/16)	60 (2-23/64)	35 (1-25/64)
	CA7-30...CA7-37; CNX-209; CAN7-37	45 (1-25/32)	81 (3-3/16)	97.5 (4)	92.6 (3-49/64)	6.5 (17/64)	① 4.5 (3/16)	60 (2-23/64)	35 (1-25/64)
	CA7-40-M... CAL7-30-M40	59 (2-21/64)	81 (3-3/16)	100.5 (4-7/64)	95.5 (3-49/64)	6.5 (17/64)	① 4.5 (3/16)	60 (2-23/64)	45 (1-25/32)
	CA7-43...CA7-55, CAN7-43, CNX-212	54 (2-1/8)	81 (3-3/16)	100.5 (4-7/64)	95.5 (3-49/64)	6.5 (17/64)	① 4.5 (3/16)	60 (2-23/64)	45 (1-25/32)
	CA7-60...CA7-97, CAN7-85 CNX-218	72 (2-53/64)	122 (4-51/64)	117 (4-49/64)	111.5 (4-35/64)	8.5 (21/64)	② 5.4 (7/32)	100 (3-15/16)	55 (2-11/64)
	CA7-90-M... CAL7-60-M40	95 (3-3/4)	122 (4-51/64)	117 (4-49/64)	111.5 (4-35/64)	8.5 (21/64)	② 5.4 (7/32)	100 (3-15/16)	55 (2-11/64)

Reversing Contactors, Capacitor Contactors & Accessories (+ ...)

Contactors with...		Dim. [mm]	Dim. [inches]
auxiliary contact block-front mounting	2-, or 4-pole	c/c1 + 39	c/c1 + 1-37/64
auxiliary contact block-side mounting	1-, or 2-pole	a + 9	a + 23/64
pneumatic timing module		c/c1 + 58	c/c1 + 2-23/64
electronic timing module	on coil terminal side	b + 24	b + 15/16
reversing contactor w-mech.interlock	on side of contactor	a+9+a	a + 23/64+a
mechanical latch		c/c1 + 61	c/c1 + 2-31/64
interface module	on coil terminal side	b + 9	b + 23/64
surge suppressor	on coil terminal side	b + 3	b + 1/8
Labeling with...	label sheet	+0	+0
	marking tag sheet with clear cover	+0	+0
	marking tag adapter for V7 Terminals	+5.5	+7/32

Mounting Position

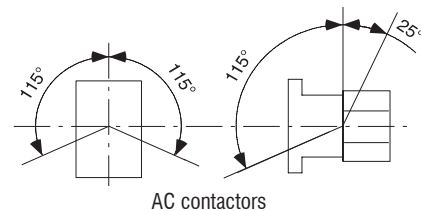

① 2 mounting holes.
② 4 mounting holes.

Series CA7 with Electronic DC Coil

Dimensions are in millimeters (inches). Dimensions not intended for manufacturing purposes.

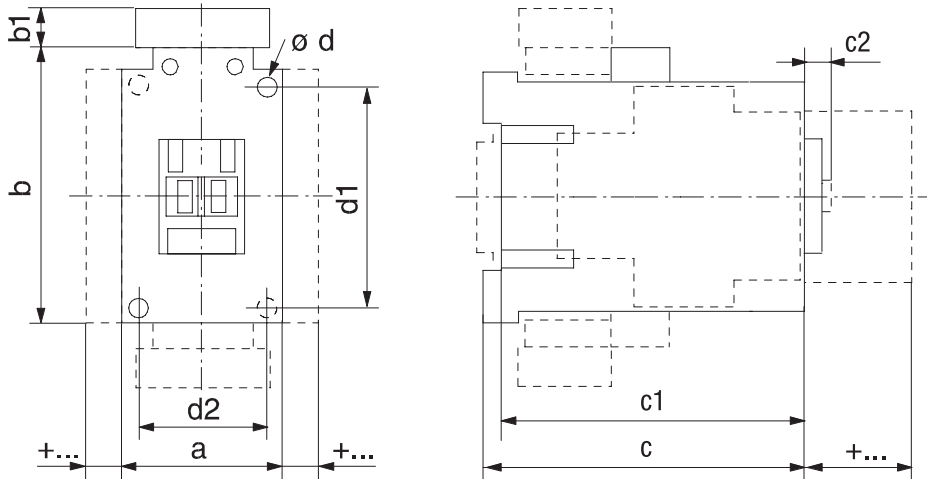

Catalog Number	Coil Code	a	b	b1	c	c1	c2	$\varnothing d$	d1	d2
CA7-9E...CA7-23E, CAN7-12E...CAN7-16E	12E...24E	45 (1-25/32)	81 (3-3/16)	~	80.5 (3-11/64)	75.5 (2-31/32)	6 (15/64)	① 4.5 (3/16)	60 (2-23/64)	35 (1-3/8)
	36E...220E	45 (1-25/32)	81 (3-3/16)	24 (15/16)	80.5 (3-11/64)	75.5 (2-31/32)	6 (15/64)	① 4.5 (3/16)	60 (2-23/64)	35 (1-3/8)
CA7-30E...CA7-37E, CAN7-37E	12E...24E	45 (1-25/32)	81 (3-3/16)	~	97.5 (4)	92.5 (3-41/64)	6.5 (1/4)	① 4.5 (3/16)	60 (2-23/64)	35 (1-3/8)
	36E...220E	45 (1-25/32)	81 (3-3/16)	24 (15/16)	97.5 (4)	92.5 (3-41/64)	6.5 (1/4)	① 4.5 (3/16)	60 (2-23/64)	35 (1-3/8)
CA7-40E	12E...24E	59 (2-21/64)	81 (3-3/16)	~	100.5 (3-61/64)	95.5 (3-49/64)	6.5 (1/4)	① 4.5 (3/16)	60 (2-23/64)	45 (1-25/32)
	36E...220E	59 (2-21/64)	81 (3-3/16)	24 (15/16)	100.5 (3-61/64)	95.5 (3-49/64)	6.5 (1/4)	① 4.5 (3/16)	60 (2-23/64)	45 (1-25/32)
CA7-43E...55E, CAN7-43E	12E...24E	54 (2-1/8)	81 (3-3/16)	~	100.5 (3-61/64)	95.5 (3-49/64)	6.5 (1/4)	① 4.5 (3/16)	60 (2-23/64)	45 (1-25/32)
	36E...220E	54 (2-1/8)	81 (3-3/16)	24 (15/16)	100.5 (3-61/64)	95.5 (3-49/64)	6.5 (1/4)	① 4.5 (3/16)	60 (2-23/64)	45 (1-25/32)

Reversing Contactors, Capacitor Contactors & Accessories (+...)

	Contactors with...	Dim. [mm]	Dim. [inches]
auxiliary contact block- front mounting	2-, or 4-pole	c/c1 + 39	c/c1 + 1-37/64
auxiliary contact block- left side mounting	1-, or 2 pole	a + 9	a + 23/64
pneumatic timing module		c/c1 + 58	c/c1 + 2-23/64
electronic timing module	on coil terminal side	b + 24	b + 15/16
mechanical latch		c/c1 + 61	c/c1 + 61
interface module	on coil terminal side	b + 9	c/c1 + 2-31/64
Labeling with...	label sheet	+0	+0
	marking tag sheet with clear cover	+0	+0
	marking tag adapter for V7 Terminals	+5.5	+7/32

Mounting Position

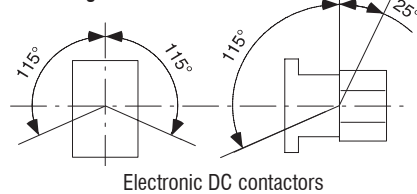

Electronic DC contactors

① 2 mounting holes.

Series CA7 with Two Winding DC Coils

Dimensions are in millimeters (inches). Dimensions not intended for manufacturing purposes.

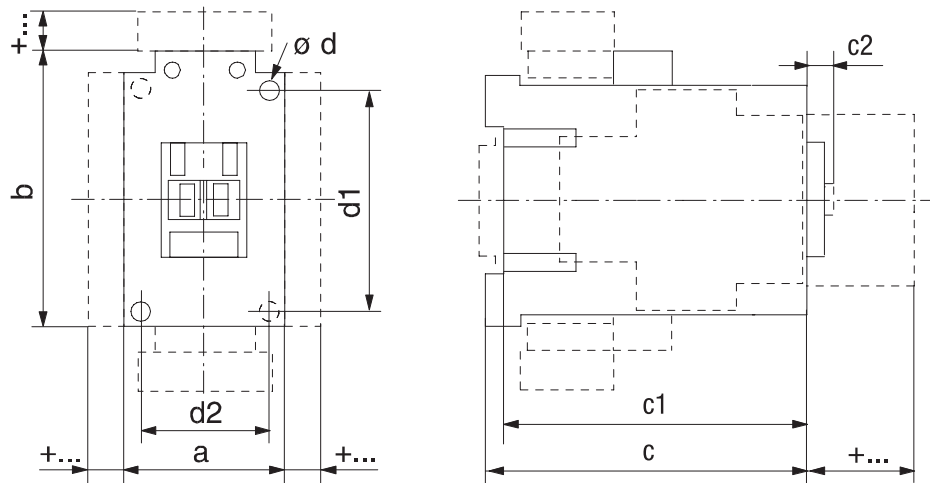

	Catalog Number	a	b	c	c1	c2	ød	d1	d2
Two Winding DC Contactors	CA7-60D...CA7-97D	72	122	117	111.5	8.5	① 5.4 (7/32)	100	55
	CAN7-85D	(2-53/64)	(4-51/64)	(4-49/64)	(4-35/64)	(21/64)		(3-15/16)	(2-11/64)
	CA7-90D	95	122	117	111.5	8.5	① 5.4 (7/32)	100	55
		(3-3/4)	(4-51/64)	(4-49/64)	(4-35/64)	(21/64)		(3-15/16)	(2-11/64)

Reversing Contactors, Capacitor Contactors & Accessories (+...)

	Contactors with...	Dim. [mm]	Dim. [inches]
	auxiliary contact block-front mounting	2-, or 4-pole	c/c1 + 39 c/c1 + 1-37/64
	auxiliary contact block- left side mounting	1-, or 2 pole	a + 9 a + 23/64
	pneumatic timing module		c/c1 + 58 c/c1 + 2-23/64
	electronic timing module	on coil terminal side	b + 24 b + 15/16
	mechanical latch		c/c1 + 61 c/c1 + 61
	interface module	on coil terminal side	b + 9 c/c1 + 2-31/64
Labeling with...	label sheet	+0	+0
	marking tag sheet with clear cover	+0	+0
	marking tag adapter for V7 Terminals	+5.5	+7/32

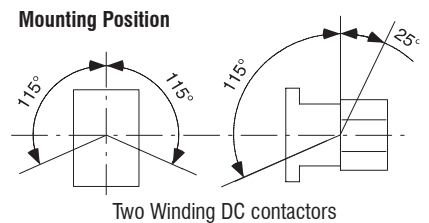

① 4 mounting holes.

CA7 Contactors with Terminal Lugs

Dimensions are in millimeters (inches). Dimensions not intended for manufacturing purposes.

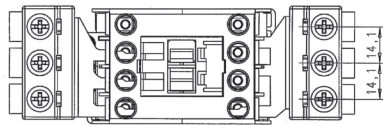
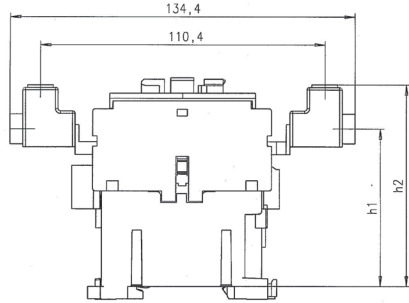

CA7-P-KN23 / KL23

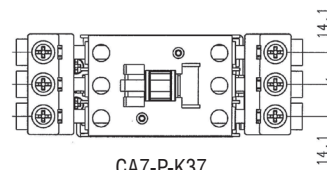
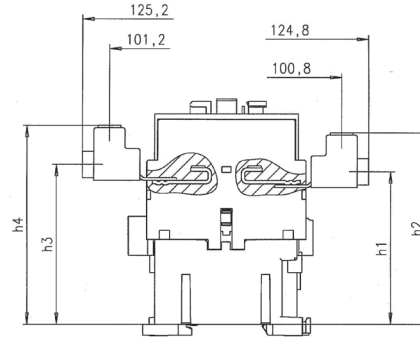

CA7-P-K37

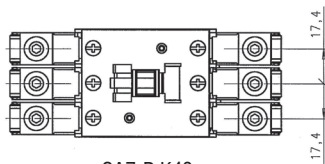
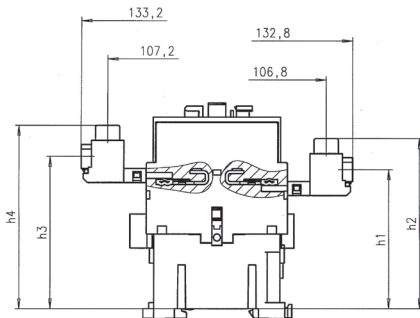

CA7-P-K43

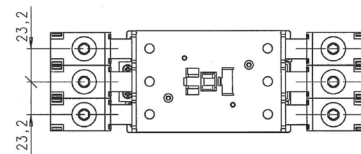
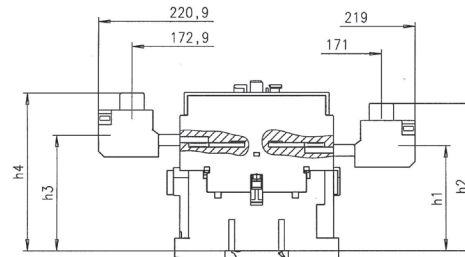

CA7-P-K85

Catalog Number	With Contactor	AC Operated Contactor				DC Operated Contactor			
		h1	h2	h3	h4	h1	h2	h3	h4
CA7-P-KN23 / KL23	CA7-9...16	61.6 (2-27/64)	78.6 (3-3/32)	~	~	87.2 (3-7/16)	104.2 (4-3/32)	~	~
	CA7-23	61.6 (2-27/64)	78.6 (3-3/32)	~	~	105.2 (4-9/64)	122.2 (4-13/16)	~	~
CA7-P-K37	CA7-30...37	67.6 (2-21/32)	84.6 (3-21/64)	71.5 (2-13/16)	88.5 (3-31/64)	111.2 (4-3/8)	128.2 (5-3/64)	115.1 (4-17/32)	132.1 (5-13/64)
CA7-P-K43	CA7-43...55	69.0 (2-23/32)	85.0 (3-11/32)	74.5 (2-15/16)	90.5 (3-9/16)	112.6 (4-7/16)	128.6 (5-1/16)	118.1 (4-21/32)	134.1 (5-9/32)
CA7-P-K85	CA7-60...97	79.7 (3-1/8)	104.7 (4-1/8)	86.7 (3-13/64)	111.7 (4-3/8)	79.7 (3-1/8)	104.7 (4-1/8)	86.7 (3-13/64)	111.7 (4-3/8)

CA7 Contactors with Paralleling Links

Dimensions are in millimeters (inches). Dimensions not intended for manufacturing purposes.

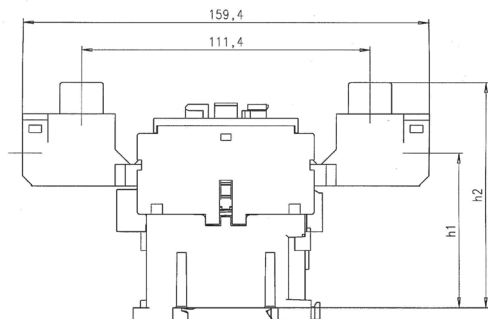

CA7-P-B23

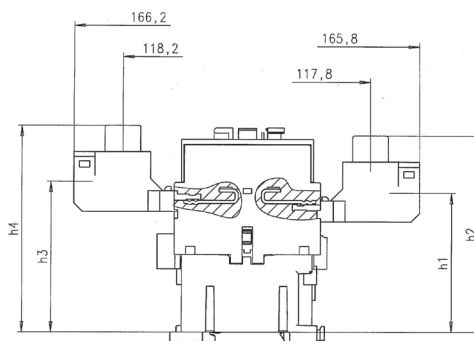

CA7-P-B37

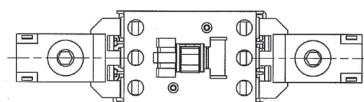
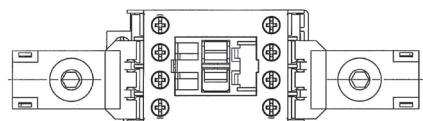

Catalog Number	With Contactor	AC Operated Contactor				DC Operated Contactor			
		h1	h2	h3	h4	h1	h2	h3	h4
CA7-P-B23	CA7-9...16	65.1 (2-9/16)	90.1 (3-9/16)	~	~	90.7 (1/4)	104.2 (2-3/16)	~	~
	CA7-23	65.1 (2-9/16)	90.1 (3-9/16)	~	~	108.7 (4-9/32)	133.7 (5-17/64)	~	~
CA7-P-K37	CA7-30...37	69.0 (2-23/32)	94.0 (3-45/64)	74.5 (2-15/16)	99.5 (3-29/32)	112.6 (4-7/16)	137.6 (5-13/32)	118.1 (4-21/32)	143.1 (5-5/8)